

McWane, Inc.

PIPE ECONOMY



Pipe Economy Catalog

Ductile Iron Pipe

Fittings

Fire Hydrants

Valves

Technical Data

Literature

PSCIPCO-Ductile Iron Pipe

PSCIPCO-Thrust-Lock™

Clow Valve-Hydrant Ordering

Home

Contacts (with web links)

Acrobat Help

PIPE ECONOMY

2003

**PA COMPLETE CATALOG
AND REFERENCE BOOK
FOR ENGINEERS, BUYERS
AND USERS OF PIPE,
FITTINGS, VALVES AND
FIRE HYDRANTS**

———— PUBLISHED BY ————

McWane, Inc.

Post Office Box 43327
Birmingham, AL 35243
(205) 414-3100

&

Ransom Industries, Inc.

Post Office Box 10686
Birmingham, AL 35202
(205) 583-3281

This catalogue is provided by McWane, Inc. and Ransom Industries, Inc. as a service to their customers. While we make every effort to generate an accurate and complete catalogue, we do not warrant or guarantee that the information is accurate or complete, and expressly disclaim all liability in the event it is not. Customers should take all steps necessary to confirm the dimensions, specifications, and suitability of the products by independent means, and should not rely upon the information in the catalogue absent independent verification.

Copyright© 2003
by McWane, Inc. & Ransom Industries, Inc.
\$10.00

MCWANE, INC. DIVISION OFFICES

The several divisions of McWane, Inc. have sales representatives and distributors in principal cities.
Contact the General Offices listed below for the name of your local representative.

ATLANTIC STATES CAST IRON PIPE COMPANY

183 Sitgreaves Street • Phillipsburg, N.J. 08865
(908) 454-1161 • Fax (908) 454-1026

www.atlanticstates.com

CANADA PIPE COMPANY Ltd.

1757 Burlington Street East • Hamilton, Ontario L8H
3L5 • (905) 547-3251 • Fax (905) 547-3248

CLOW CANADA CO.

(Concord-Diagle/McAvity)

1757 Burlington Street East • Hamilton, Ontario L8H
3L5 • (905) 548-9604 • Fax (905) 548-6885

CLOW WATER SYSTEMS COMPANY

P.O. Box 6001 • Coshocton, Ohio 43812
(740) 622-6651 • Fax (740) 622-8551

www.clowwatersystems.com

CLOW VALVE COMPANY

902 South 2nd Street • Oskaloosa, Iowa 52577
(515) 673-8611 • Fax (515) 673-5514

www.clowvalve.com

KENNEDY VALVE

1021 E. Water Street • Elmira, New York 14901
(607) 734-2211 • Fax (607) 734-3288

www.kennedyvalve.com

M & H VALVE COMPANY

P.O. Box 2088 • Anniston, Alabama 36202
(256) 237-3521 • Fax (256) 237-8630

www.mh-valve.com

McWANE CAST IRON PIPE COMPANY

1201 Vanderbilt Road • Birmingham, Alabama 35234
(205) 322-3521 • Fax (205) 324-7250

www.mcwanepipe.com

PACIFIC STATES CAST IRON PIPE COMPANY

P.O. Box 1219 • Provo, Utah 84603
(801) 373-6910 • Fax (801) 377-0338

www.pscipco.com

RANSOM INDUSTRIES, INC. DIVISION OFFICES

ANACO

1001 Compton Ave. • Corona, California 91719
(909) 372-2732 • Fax (909) 738-1183

Bibby-Ste-Croix

P.O. Box 280 • Ste-Croix, Quebec, Canada G0S 2H0
(418) 926-3262 • Fax (418) 926-2430

TYLER COUPLING

P.O. Box H • 1300 Tyler Road • Marshfield, Missouri
65706 • (417) 468-2804 • Fax (417) 468-2835

TYLER PIPE

P.O. Box 2027 • Tyler, Texas 75710
(903) 882-5511 • Fax (903) 882-2347

www.tylerpipe.com

TYLER PIPE - PENN DIVISION

101 North Church Street • Macungie, Pennsylvania
18062 • (610) 966-3491 • Fax (610) 966-2221

UNION FOUNDRY COMPANY

P.O. Box 309 • Anniston, Alabama 36202
(256) 236-7601 • Fax (256) 236-7758

www.ufco.com

THE BENEFITS OF DUCTILE IRON PIPE ARE PROVEN... NOT PROMISED!



LONG LIFE...

Indefinitely long, underground or above ground. Life expectancy of cast iron proved to be 100 years or more. All a matter of record.

HIGH FLOW CAPACITY...

Large internal diameter; smooth bore, with the ability to stay smooth. Delivers more water.

TROUBLE-FREE SERVICE...

User-designed to engineering standards; permanently tight joints; high structural strength; easy to cut, drill and tap.

No other pipe can provide all of these essential requirements at so low a cost.

LIMITED WARRANTY

McWane, Inc. warrants that the goods described in this catalog shall conform substantially to the descriptions and specifications contained in the order, if any, and be free from defects in material and workmanship under conditions of normal use. McWane shall not be responsible for any defects resulting from normal wear and tear, erosion or corrosion, improper storage, use or maintenance. Component parts and products manufactured and warranted by others shall be subject only to the warranties extended by the manufacturers of said component parts or products. McWane will, as an accommodation to buyer, assign any warranties given to it by any such manufacturers. McWane shall in no event be liable for any exemplary, punitive, special, incidental or consequential loss, damage, injury or expense of any kind arising from the manufacture, sale, installation, use or shipment of the goods, or from any other cause relating thereto, including, but not limited to, loss of profit or revenues, loss of use of the goods or any associated goods or equipment, damage to property of the buyer, cost of capital, cost of substitute goods, downtime, or the claims of buyer's customers for any of the above, and McWane's sole liabil-

ity and buyer's exclusive remedy in any case is limited to, at McWane's election, the repair or replacement (in the form originally shipped) of goods not in compliance with applicable standards, or to the repayment of, or crediting the buyer with, an amount equal to the purchase price of such goods, whether claims are based on contract warranty, tort (including negligence), strict liability or any other basis of recovery whatsoever. Any claims or exceptions for defective material which reasonably should be discovered by the buyer upon receipt of the goods must be made in writing within ten (10) days after buyer's receipt of materials. Further, buyer shall give McWane an opportunity to investigate the allegedly defective goods.

THE FOREGOING WARRANTY IS IN LIEU OF AND EXCLUDES ALL OTHER WARRANTIES NOT EXPRESSLY SET FORTH HEREIN, WHETHER EXPRESS OR IMPLIED BY OPERATION OF LAW OR OTHERWISE, INCLUDING, BUT NOT LIMITED TO, ANY IMPLIED WARRANTIES OF MERCHANTABILITY OR FITNESS FOR A PARTICULAR PURPOSE.

CONTENTS

SECTION I.	Ductile Iron Pipe
SECTION II.	Fittings
SECTION III.	Fire Hydrants
SECTION IV.	Valves
APPENDIX	Technical Data
MASTER INDEX	



DUCTILE IRON PIPE

ATLANTIC STATES CAST IRON PIPE COMPANY

CANADA PIPE COMPANY LTD.

CLOW WATER SYSTEMS COMPANY

MCWANE CAST IRON PIPE COMPANY

PACIFIC STATES CAST IRON PIPE COMPANY

This page intentionally left blank.

PIPE ECONOMY

CONTENTS

The Advancement of Ductile Iron Pipe	7
Evolution of Cast Iron Pipe Standards	8
Push-On Joint Pipe	9
Mechanical Joint Pipe	12
Installation of Ductile Iron Water Mains and Their Appurtenances	14
Assembly of Field-Cut Pipe	19
Ordering and Quotation Information	20
CLOW Ball and Socket Pipe	20
Restrained Joint Pipe	26
Flanged Joint Pipe	32
CLOW Long-Span Pipe	33
Linings for Pipe and Fittings	34
Provision for Electrical Thawing	35
Making Offsets on the Job	36
Index	37

This page intentionally left blank.

PIPE ECONOMY

THE ADVANCEMENT OF DUCTILE IRON PIPE

Photomicrograph of gray cast iron (100x) showing carbon in the form of graphite flakes.

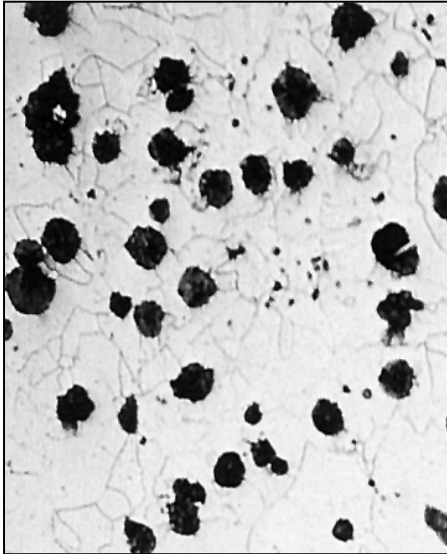

Photomicrograph of Ductile Cast Iron (100x) showing carbon in the form of graphite nodules.

Cast Iron Pipe has long been the standard material for conveying water and sewage in municipal, utility and industrial piping systems.

The real life expectancy of cast iron pipe is unknown, but is usually estimated at 100 years or more. The oldest operating cast iron main is that at Versailles, France, installed in 1664. In this country and in Canada there are more than 500 members of the Cast Iron Pipe Century Club, a unique organization composed of cities or utilities who have cast iron pipe still in service after 100 years.

Ductile Iron Pipe, a product of advanced metallurgy, offers unique properties for conveying water under pressure, and other piping uses. It combines the physical strength of mild steel with the long life of gray cast iron.

Ductile iron offers the greatest possible margin of safety against service failures due to ground movement and beam stresses. Virtually unbreakable in ordinary service, it also provides increased resistance to breakage caused by rough handling in shipping and installation.

The corrosion resistance of ductile iron pipe has been proved in a wide variety of accelerated tests to be at least the equal of gray cast iron.

Ductile iron is produced by adding a closely controlled amount of magnesium alloy to a molten iron of low phosphorous and low sulfur content. The magnesium alloy addition produces a remarkable change in the microstructure by causing the carbon in the iron to assume a spheroidal or nodular shape, (as contrasted to the flake form of graphite in gray cast iron), and at the same time producing a finer grained iron matrix in the surrounding ferrite structure. As a result of this remarkable change, a far stronger, tougher, and ductile material is obtained.

In addition to the benefits of long life, corrosion resistance, high structural strength, and tight joints, ductile iron is also readily machinable, an important requirement in any pipe that must be drilled, tapped or cut.

The McWane Companies manufacture Ductile Iron Pipe in strict accordance with design criteria that have been developed by the American National Standards Institute, and which equals or exceeds the requirements of all published standards of the American Water Works Association.

EVOLUTION OF CAST IRON PIPE STANDARDS

Prior to 1902, there were no standard specifications for cast iron pipe in the United States. Pipe was furnished to individual user specifications or to the manufacturer's own standard.

The first published standards for cast iron pipe were issued by the New England Water Works Association in 1902 and by the American Society for Testing Materials in 1904. However, the first widely accepted standards were those adopted by the American Water Works Association in 1908 covering both pit cast gray iron pipe and gray iron fittings.

Separate specifications for pit cast gray iron pipe and fittings for gas were adopted by the American Gas Institute in 1911, and were revised and reissued by the American Gas Association in 1929.

In 1927, Federal Specifications FS-537 were issued covering cast iron water pipe, centrifugally cast. These specifications were superseded by Federal Specifications WW-P-421 in 1931.

In 1926, Committee A21 of the American Standard's Association was formed to prepare new standard specifications for cast iron pipe under the sponsorship of the AGA, ASTM, AWWA, and NEWWA. Participating in this study were representatives of sponsors, consumers, producers, and consulting engineers.

The result of this comprehensive, scientific study was the issuing in 1939 of ASA A21.1, "Manual for the Computation of Strength and Thickness of Cast Iron Pipe." This manual took into account the combined effect of trench loads, internal pressure, water-hammer, laying conditions and corrosion, all with a built-in factor of safety. At the time it represented the best available knowledge that could be applied to cast iron pipe design. ASA Manual A21.1 was the basis for the several specifications which in 1952 and 1953 were first issued by the American Standards Association and adopted by its sponsoring bodies.

In 1939, ASA A21.4 "Specifications for Cement-Mortar Lining of Cast-Iron Pipe and Fittings" was published.

In 1949, the first comprehensive standard covering the installation of water-main was published by the American Water Works Association, "Standard Specifications for Installation of Cast-Iron Water Mains, (C-600)."

In 1955, the Federal Specifications Board issued a revised WW-P-421 specification, WW-P-421a, which was later superseded by WW-P-421b and WW-P-421c. Weights, thicknesses and dimensions of pipe in this specification conformed to the appropriate provisions of ASA specifications.

In 1965, ASA A21.50 (AWWA Manual H3) was adopted, covering ductile iron pipe design, along with ASA A21.51 (AWWA C151) Ductile Iron Pipe for Water, and ASA A21.52, Ductile iron Pipe for Gas.

In 1968, A21.14, "Gray Iron and Ductile Iron Fittings for Gas," was adopted by the standards association.

In 1969, the standards association changed its name to American National Standards Institute, Inc. It also changed the designation of its standards to "American National Standard," abbreviated ANSI for the identification of documents: as ANSI A21.11.

In 1972, the Standards Institute adopted A21.5 (AWWA C105), "Polyethylene Encasement for Gray and Ductile Cast Iron Piping for Water and Other Liquids."

In 1975, the Standards Institute adopted A21.15 (AWWA C115), "Standard for Flanged Ductile-Iron Pipe with Ductile iron or gray iron threaded flanges."

In 1984, Committee A21 of ANSI, became an AWWA committee, "American Water Works Association Standards Committee A21 on Ductile Iron Pipe and Fittings."

In 1991, the Standards Institute adopted pressure classes as the standard designation for Ductile Iron Pipe in lieu of thickness classes.

For information, selected parts of some standards have been reproduced in the Technical Data Section of this catalog and complete copies of such standards will be furnished on request. It is our policy, however, in the absence of customer specification to the contrary, to furnish ductile iron pipe and fittings conforming with the latest revision of the applicable standards.

PUSH-ON JOINT DUCTILE IRON PIPE
Standard Dimensions and Weights (Pressure Classes)

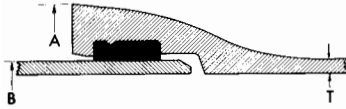

Tyton® Joint Type
Sizes 3" - 24"

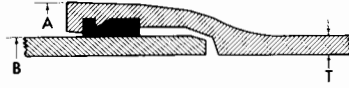

Fastite® Joint Type
Sizes 30" - 36"

PIPE SIZE IN.	PRESSURE CLASS	THICKNESS	OD† IN.	WEIGHT OF BARREL PER FOOT LB	WEIGHT OF BELL LB	18-FT. LAYING LENGTH		20-FT. LAYING LENGTH	
						WEIGHT PER LENGTH LB	AVERAGE WEIGHT PER FOOT** LB	WEIGHT PER LENGTH \$LB	AVERAGE WEIGHT PER FOOT** LB
3	350	0.25	3.96	8.9	7.0			185	9.2
4	350	0.25	4.80	10.9	9.0			225	11.3
6	350	0.25	6.90	16.0	11.0	300	16.6	330	16.6
8	350	0.25	9.05	21.1	17.0	395	22.0	440	22.0
10	350	0.26	11.10	27.1	24.0	510	28.4	575	28.7
12	350	0.28	13.20	34.8	29.0	655	36.4	735	36.7
14	250	0.28	15.30	40.4	45.0	770	42.9		
	300	0.30	15.30	43.3	45.0	825	45.8		
	350	0.31	15.30	44.7	45.0	850	47.2		
16	250	0.30	17.40	49.3	54.0	940	52.3		
	300	0.32	17.40	52.5	54.0	1000	55.5		
	350	0.34	17.40	55.8	54.0	1060	58.8		
	350	0.31	19.50	57.2	59.0	1090	60.5		
18	300	0.34	19.50	62.6	59.0	1185	65.9		
	350	0.36	19.50	66.2	59.0	1250	69.5		
	350	0.33	21.60	67.5	74.0	1290	71.6		
20	300	0.36	21.60	73.5	74.0	1395	77.6		
	350	0.38	21.60	77.5	74.0	1470	81.6		
	200	0.33	25.80	80.8	95.0	1550	86.1		
24	250	0.37	25.80	90.5	95.0	1725	95.8		
	300	0.40	25.80	97.7	95.0	1855	103.0		
	350	0.43	25.80	104.9	95.0	1985	110.2		
	30	150	0.34	32.00	103.5	139.0	2000	111.2	
30	200	0.38	32.00	115.5	139.0	2220	123.2		
	250	0.42	32.00	127.5	139.0	2435	135.2		
	300	0.45	32.00	136.5	139.0	2595	144.2		
	350	0.49	32.00	148.4	139.0	2810	156.1		
36	150	0.38	38.30	138.5	184.0	2675	148.7		
	200	0.42	38.30	152.9	184.0	2935	163.1		
	250	0.47	38.30	170.9	184.0	3260	181.1		
	300	0.51	38.30	185.3	184.0	3520	195.5		
350	0.56	38.30	203.2	184.0	3840	213.4			

*To convert inches to millimeters, multiply by 25.4; to convert feet to meters, multiply by 0.3048; to convert pounds to kilograms, multiply by 0.4536; to convert pounds per foot to kilograms per metre, multiply by 1.488.

†Tolerance of OD of spigot end: 3-12 in., ±0.06 in.; 14-24 in., +0.05 in., -0.08 in.; 30-36 in., +0.08 in., -0.06 in.

The bell weights shown above are adequate for 350-psi (2413-kPa) operating pressure. Bell weights vary due to differences in push-on-joint design. The manufacturer shall calculate pipe weights using standard barrel weights and weights of bells being produced.

‡ Including bell; calculated weight of pipe rounded off to nearest 5 lb.

**Including bell; average weight per foot based on calculated weight of pipe before rounding.

PUSH-ON JOINT DUCTILE IRON PIPE
*Dimensions and Weights for Special Classes***

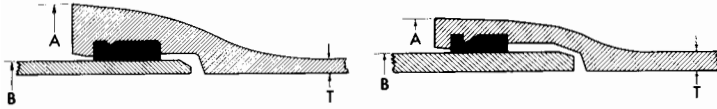

Tyton® Joint Type
Sizes 3" - 24"

Fastite® Joint Type
Sizes 30" - 36"

NOMINAL INSIDE DIAMETER INCHES	WALL THICKNESS		DIMENSIONS-INCHES		APPROXIMATE WEIGHT-POUNDS					
	ANSI THICK. CLASS	T IN INCHES	A BELL O.D.	B PIPE O.D.	BELL METAL ONLY	PIPE BARREL PER FT.	18 Ft LAYING LENGTH		20 Ft LAYING LENGTH	
							PER* LENGTH	PER* FOOT	PER* LENGTH	PER* FOOT
3	51	.25	5.80	3.96	7	8.9	165	9.3	185	9.2
	52	.28	5.80	3.96	7	9.9	185	10.3	205	10.2
	53	.31	5.80	3.96	7	10.9	205	11.3	225	11.2
	54	.34	5.80	3.96	7	11.8	220	12.2	245	12.2
	55	.37	5.80	3.96	7	12.8	235	13.2	265	13.2
	56	.40	5.80	3.96	7	13.7	255	14.1	280	14.0
4	51	.26	6.86	4.80	9	11.3	210	11.8	235	11.8
	52	.29	6.86	4.80	9	12.6	235	13.1	260	13.0
	53	.32	6.86	4.80	9	13.8	255	14.3	285	14.2
	54	.35	6.86	4.80	9	15.0	280	15.5	310	15.4
	55	.38	6.86	4.80	9	16.1	300	16.6	330	16.6
	56	.41	6.86	4.80	9	17.3	320	17.8	355	17.8
6	50	.25	8.75	6.90	11	16.0	300	16.6	330	16.6
	51	.28	8.75	6.90	11	17.8	330	18.4	365	18.3
	52	.31	8.75	6.90	11	19.6	365	20.2	405	20.2
	53	.34	8.75	6.90	11	21.4	395	22.0	440	22.0
	54	.37	8.75	6.90	11	23.2	430	23.8	475	23.8
	55	.40	8.75	6.90	11	25.0	460	25.6	510	25.6
8	56	.43	8.75	6.90	11	26.7	490	27.3	545	27.2
	50	.27	11.05	9.05	17	22.8	425	23.7	475	23.7
	51	.30	11.05	9.05	17	25.2	470	26.1	520	26.0
	52	.33	11.05	9.05	17	27.7	515	28.6	570	28.6
	53	.36	11.05	9.05	17	30.1	560	31.0	620	31.0
	54	.39	11.05	9.05	17	32.5	600	33.4	665	33.3
10	55	.42	11.05	9.05	17	34.8	645	35.7	715	35.7
	56	.45	11.05	9.05	17	37.2	685	38.1	760	38.0
	50	.29	13.15	11.10	24	30.1	565	31.4	625	31.3
	51	.32	13.15	11.10	24	33.2	620	34.5	690	34.4
	52	.35	13.15	11.10	24	36.2	675	37.5	750	37.4
	53	.38	13.15	11.10	24	39.2	730	40.5	810	40.4
12	54	.41	13.15	11.10	24	42.1	780	43.4	865	43.3
	55	.44	13.15	11.10	24	45.1	835	46.4	925	46.3
	56	.47	13.15	11.10	24	48.0	890	49.3	985	49.2
	50	.31	15.30	13.20	29	38.4	720	40.0	795	39.8
	51	.34	15.30	13.20	29	42.0	785	43.6	870	43.4
	52	.37	15.30	13.20	29	45.6	850	47.2	940	47.0
12	53	.40	15.30	13.20	29	49.2	915	50.8	1015	50.7
	54	.43	15.30	13.20	29	52.8	980	54.4	1085	54.2
	55	.46	15.30	13.20	29	56.3	1040	57.9	1155	57.8
	56	.49	15.30	13.20	29	59.9	1105	61.5	1225	61.4

Depth of Bells: 3" - 3.00"; 4" - 3.15"; 6" - 3.38"; 8" - 3.69"; 10" & 12" - 3.75"

Nominal laying lengths: 3" & 4" -20'-0"; 6" thru 12"-18' or 20'-0"; 14" thru 36"-18'-0".

*Including bell. Calculated weight rounded off to nearest 5 pounds.

** "Special Classes" shown above were designated "Standard Thickness Classes" in the previous editions of ANSI/AWWA C151/A21.51.

Dimensions and Weights for Special Classes (continued)

NOMINAL INSIDE DIAMETER INCHES	WALL THICKNESS		DIMENSIONS-INCHES		APPROXIMATE WEIGHT-POUNDS			
	ANSI THICK. CLASS	T IN INCHES	A BELL O.D.	B PIPE O.D.	BELL METAL ONLY	PIPE BARREL PER FT.	18 FT LAYING LENGTH	
							PER* LENGTH	PER* FOOT
14	50	.33	17.85	15.30	60	47.5	900	50.0
	51	.36	17.85	15.30	60	51.7	975	54.2
	52	.39	17.85	15.30	60	55.9	1050	58.4
	53	.42	17.85	15.30	60	60.1	1125	62.6
	54	.45	17.85	15.30	60	64.2	1200	66.7
	55	.48	17.85	15.30	60	68.4	1275	70.9
	56	.51	17.85	15.30	60	72.5	1350	75.0
16	50	.34	20.00	17.40	68	55.8	1060	58.8
	51	.37	20.00	17.40	68	60.6	1145	63.6
	52	.40	20.00	17.40	68	65.4	1230	68.4
	53	.43	20.00	17.40	68	70.1	1315	73.1
	54	.46	20.00	17.40	68	74.9	1400	77.9
	55	.49	20.00	17.40	68	79.7	1490	82.7
	56	.52	20.00	17.40	68	84.4	1575	87.4
18	50	.35	22.10	19.50	78	64.4	1220	67.7
	51	.38	22.10	19.50	78	69.8	1315	73.1
	52	.41	22.10	19.50	78	75.2	1415	78.5
	53	.44	22.10	19.50	78	80.6	1510	83.9
	54	.47	22.10	19.50	78	86.0	1605	89.3
	55	.50	22.10	19.50	78	91.3	1700	94.5
	56	.53	22.10	19.50	78	96.7	1800	100.0
20	50	.36	24.25	21.60	87	73.5	1395	77.6
	51	.39	24.25	21.60	87	79.5	1505	83.6
	52	.42	24.25	21.60	87	85.5	1615	89.6
	53	.45	24.25	21.60	87	91.5	1720	95.6
	54	.48	24.25	21.60	87	97.5	1830	101.6
	55	.51	24.25	21.60	87	103.4	1935	107.5
	56	.54	24.25	21.60	87	109.3	2040	113.4
24	50	.38	28.50	25.80	105	92.9	1765	98.1
	51	.41	28.50	25.80	105	100.1	1895	105.4
	52	.44	28.50	25.80	105	107.3	2025	112.6
	53	.47	28.50	25.80	105	114.4	2155	119.7
	54	.50	28.50	25.80	105	121.6	2285	126.9
	55	.53	28.50	25.80	105	128.8	2415	134.1
	56	.56	28.50	25.80	105	135.9	2540	141.2
30	50	.39	34.95	32.00	170	118.5	2270	126.2
	51	.43	34.95	32.00	170	130.5	2490	138.2
	52	.47	34.95	32.00	170	142.5	2705	150.2
	53	.51	34.95	32.00	170	154.4	2920	162.1
	54	.55	34.95	32.00	170	166.3	3130	174.0
	55	.59	34.95	32.00	170	178.2	3345	185.9
	56	.63	34.95	32.00	170	190.0	3560	197.7
36	50	.43	41.37	38.30	239	156.5	3000	166.7
	51	.48	41.37	38.30	239	174.5	3325	184.7
	52	.53	41.37	38.30	239	192.4	3645	202.6
	53	.58	41.37	38.30	239	210.3	3970	220.5
	54	.63	41.37	38.30	239	228.1	4290	238.3
	55	.68	41.37	38.30	239	245.9	4610	256.1
	56	.73	41.37	38.20	239	263.7	4930	273.9

Depth of Bells: 14" thru 24" - 5.00"; 30" & 36" - 6.50"

Nominal laying lengths: 3" & 4" - 20'-0"; 6" thru 12"-18' or 20'-0"; 14" thru 36"-18'-0"

*Including bell. Calculated weight rounded off to the nearest 5 pounds.

MECHANICAL JOINT DUCTILE IRON PIPE
*Dimensions and Weights for Special Classes***

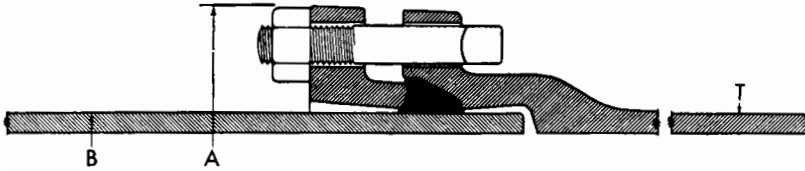

NOMINAL INSIDE DIAMETER INCHES	WALL THICKNESS		DIMENSIONS-INCHES		APPROXIMATE WEIGHT-POUNDS					
	ANSI THICK. CLASS	T IN INCHES	A GLAND O.D.	B PIPE O.D.	BELL METAL ONLY	PIPE BARREL PER FT.	18 Ft LAYING LENGTH		20 Ft LAYING LENGTH	
							PER* LENGTH	PER* FOOT	PER* LENGTH	PER* FOOT
3	51	.25	7.69	3.96	9	8.9	170	9.4	185	9.3
	52	.28	7.69	3.96	9	9.9	185	10.4	205	10.3
	53	.31	7.69	3.96	9	10.9	205	11.4	225	11.3
	54	.34	7.69	3.96	9	11.8	220	12.3	245	12.2
	55	.37	7.69	3.96	9	12.8	240	13.3	265	13.2
	56	.40	7.69	3.96	9	13.7	255	14.2	285	14.2
4	51	.26	9.12	4.80	13	11.3	215	12.0	240	12.0
	52	.29	9.12	4.80	13	12.6	240	13.3	265	13.2
	53	.32	9.12	4.80	13	13.8	260	14.5	290	14.4
	54	.35	9.12	4.80	13	15.0	285	15.7	315	15.7
	55	.38	9.12	4.80	13	16.1	305	16.9	335	16.8
	56	.41	9.12	4.80	13	17.3	325	18.0	360	18.0
6	50	.25	11.12	6.90	18	16.0	305	17.0	340	16.9
	51	.28	11.12	6.90	18	17.8	340	18.8	375	18.7
	52	.31	11.12	6.90	18	19.6	370	20.6	410	20.5
	53	.34	11.12	6.90	18	21.4	405	22.4	445	22.3
	54	.37	11.12	6.90	18	23.2	435	24.2	480	24.1
	55	.40	11.12	6.90	18	25.0	470	26.0	520	25.9
8	56	.43	11.12	6.90	18	26.7	500	27.7	550	27.6
	50	.27	13.37	9.05	24	22.8	435	24.1	480	24.0
	51	.30	13.37	9.05	24	25.2	480	26.6	530	26.4
	52	.33	13.37	9.05	24	27.7	525	29.1	580	28.9
	53	.36	13.37	9.05	24	30.1	565	31.4	625	31.3
	54	.39	13.37	9.05	24	32.5	610	33.8	675	33.7
10	55	.42	13.37	9.05	24	34.8	650	36.1	720	36.0
	56	.45	13.37	9.05	24	37.2	695	38.5	770	38.4
	50	.29	15.62	11.10	31	30.1	575	31.9	635	31.7
	51	.32	15.62	11.10	31	33.2	630	34.9	695	34.8
	52	.35	15.62	11.10	31	36.2	685	38.0	755	37.8
	53	.38	15.62	11.10	31	39.2	735	40.9	815	40.8
12	54	.41	15.62	11.10	31	42.1	790	43.8	875	43.7
	55	.44	15.62	11.10	31	45.1	845	46.9	935	46.7
	56	.47	15.62	11.10	31	48.0	895	49.7	990	49.6
	50	.31	17.88	13.20	37	38.4	730	40.5	805	40.2
	51	.34	17.88	13.20	37	42.0	795	44.1	875	43.8
	52	.37	17.88	13.20	37	45.6	860	47.7	950	47.4
12	53	.40	17.88	13.20	37	49.2	925	51.3	1020	51.0
	54	.43	17.88	13.20	37	52.8	985	54.8	1095	54.7
	55	.46	17.88	13.20	37	56.3	1050	58.4	1165	58.2
	56	.49	17.88	13.20	37	59.9	1115	62.0	1235	61.8

Depth of Bells: 3" thru 12" - 2.50"; 14" thru 24" - 3.50"

Nominal laying lengths: 3" & 4" - 20'- 0"; 6" thru 12"-18' or 20'-0"; 14" thru 24"-18'-0".

*Including bell. Calculated weight rounded off to nearest 5 pounds

** "Special Classes" shown above were designated "Standard Thickness Classes" in the previous editions of ANSI/AWWA C151/A21.51.

MECHANICAL JOINT DUCTILE IRON PIPE (CONTINUED)

DIMENSIONS AND WEIGHTS FOR SPECIAL CLASSES

NOMINAL INSIDE DIAMETER INCHES	WALL THICKNESS		DIMENSIONS-INCHES		APPROXIMATE WEIGHT-POUNDS			
	ANSI THICK. CLASS	T IN INCHES	A GLAND O.D.	B PIPE O.D.	BELL METAL ONLY	PIPE BARREL PER FT.	18 Ft LAYING LENGTH	
							PER* LENGTH	PER* FOOT
14	50	.33	20.25	15.30	61	47.5	915	50.9
	51	.36	20.25	15.30	61	51.7	990	55.1
	52	.39	20.25	15.30	61	55.9	1065	59.3
	53	.42	20.25	15.30	61	60.1	1145	63.5
	54	.45	20.25	15.30	61	64.2	1215	67.6
	55	.48	20.25	15.30	61	68.4	1290	71.8
	56	.51	20.25	15.30	61	72.5	1365	75.9
16	50	.34	22.50	17.40	74	55.8	1080	59.9
	51	.37	22.50	17.40	74	60.9	1165	64.7
	52	.40	22.50	17.40	74	65.4	1250	69.5
	53	.43	22.50	17.40	74	70.1	1335	74.2
	54	.46	22.50	17.40	74	74.9	1420	79.0
	55	.49	22.50	17.40	74	79.7	1510	83.8
	56	.52	22.50	17.40	74	84.4	1595	88.5
18	50	.35	24.75	19.50	85	64.4	1245	69.1
	51	.38	24.75	19.50	85	69.8	1340	74.5
	52	.41	24.75	19.50	85	75.2	1440	79.9
	53	.44	24.75	19.50	85	80.6	1535	85.3
	54	.47	24.75	19.50	85	86.0	1635	90.7
	55	.50	24.75	19.50	85	91.3	1730	96.0
	56	.53	24.75	19.50	85	96.7	1825	101.4
20	50	.36	27.00	21.60	98	73.5	1420	78.9
	51	.39	27.00	21.60	98	79.5	1530	84.9
	52	.42	27.00	21.60	98	85.5	1635	90.9
	53	.45	27.00	21.60	98	91.5	1745	96.9
	54	.48	27.00	21.60	98	97.5	1855	103.0
	55	.51	27.00	21.60	98	103.4	1960	108.8
	56	.54	27.00	21.60	98	109.3	2065	114.7
24	50	.38	31.50	25.80	123	92.9	1795	99.7
	51	.41	31.50	25.80	123	100.1	1925	106.9
	52	.44	31.50	25.80	123	107.3	2055	114.1
	53	.47	31.50	25.80	123	114.4	2180	121.2
	54	.50	31.50	25.80	123	121.6	2310	128.4
	55	.53	31.50	25.80	123	128.8	2440	135.6
	56	.56	31.50	25.80	123	135.9	2570	142.7

Depth of Bells: 3" thru 12" - 2.50"; 14" thru 24" - 3.50"

Nominal laying lengths: 3" & 4" - 20'-0"; 6" thru 12"-18' or 20'-0"; 14" thru 24"-18'-0".

*Including bell. Calculated weight rounded off to nearest 5 pounds

MAXIMUM DEFLECTIONS OF MECHANICAL JOINT PIPE

SIZE OF PIPE INCHES	BASED ON 18-Ft. LENGTH		APPROX. RADIUS IN FEET OF CURVE PRODUCED BY SUCCESSION OF JOINTS	APPROX. NUMBER OF 18-FOOT PIPE REQUIRED FOR A 90° BEND
	ANGLE DEGREES	DEFLECTION INCHES		
3	8°-18'	35.0†	140	11†
4	8°-18'	35.0†	140	11†
6	7°-7'	27.0	145	13
8	5°-21'	20.0	195	17
10	5°-21'	20.0	195	17
12	5°-21'	20.0	195	17
14	3°-35'	13.5	285	25
16	3°-35'	13.5	285	25
18	3°-0'	11.0	340	30
20	3°-0'	11.0	340	30
24	2°-23'	9.0	450	39

†20 Ft. Length

INSTALLATION OF DUCTILE-IRON WATER MAINS AND THEIR APPURTENANCES

All ductile iron pipe, valves, hydrants and fittings should be installed and tested in accordance with applicable AWWA and other industry standards. **It is the installer's obligation to know and understand all applicable standards and specifications and to follow them in all situations.** It is also the purchaser/installer's obligation and responsibility to make certain that all of its employees understand and follow these standards. Specific standards that are applicable include, but may not be limited to ANSI/AWWA C600-93, C500-86, C502-85, C503-88, C504-94, C509-87, C800-84, C504, C508, C111/A-21.11-85, and the considerations outlined in AWWA Manuals M17, M41, and M44. The Ductile Iron Pipe Research Association also publishes an installation guide for ductile iron pipe. This guide is available from McWane, Inc. Pipe Divisions, Ransom Industries, Inc. or directly from the Ductile Iron Pipe Research Association, located at 245 Riverchase Parkway East, Suite 0, Birmingham, AL 35244, Telephone 205/402-8700, FAX 205/402-8730.

The following guidelines apply to most installations of ductile iron pipe and appurtenances. **These guidelines are not intended as a substitute for the applicable standards and specifications, which should be followed in all instances.**

All pipe and appurtenances should be inspected carefully at the point of delivery for damage and other defects immediately before installation. Any lumps, blisters, excess coating or cement, or other foreign matter should be removed from the socket and plain ends of each pipe, and the outside of the plain end and the inside of the bell wiped clean and dry and be free from dirt, sand, grit, cement, excess coating or any other foreign material before the pipe is laid. Valves should be inspected for direction of opening, for consistency with other valves in the system, number of turns to open, freedom of operation, tightness of pressure-containing bolting and test plugs, tightness of the nuts and bolts, cleanliness of valve ports, end-joints, and especially seating surfaces, handling damage, and cracks. Hydrants shall be inspected for direction of opening, nozzle threading, operating nut and cap nut dimensions, tightness of pressure-containing bolting, cleanliness of inlet elbow, handling damage, and cracks. Any defective materials should be marked, repaired, or held for inspection by the owner.

Water and sewer mains shall be laid and maintained to lines and grades established by

the plans and specifications for the project. Fittings, valves, tapped or bossed outlets, and hydrants must be installed at the required locations unless changes are approved in accordance with applicable specifications. Each joint should be inspected prior to backfilling to make certain the gasket has not been pushed or dislodged from the socket. This inspection can be accomplished visually with large diameter lines and by use of a feeler gauge with smaller diameter lines.

Figures 1, 2, and 3, on pages 14-16, generally describe the laying conditions for ductile iron pipe and the proper method of assembly of push-on joint and mechanical joint pipe. **However, the installer is responsible for making certain that the assembly complies with all applicable standards and specifications.**

Prior to installation of hydrants and valves, the direction of opening, operating nuts, hose nozzle threads and steamer nozzle threads must be checked to make certain they comply with the other hydrants in your city. We will not be responsible if advised of incorrect operating nuts and nozzle threads after installation. The hydrant should be opened and closed at least twice a year to insure proper operation and drainage. Store hydrant bottom inlet downward to prevent freezing. Check all bolts and nuts for tightness. Do not lift hydrant without use of slings.

Prior to conducting any pressure testing of pipe, the installed components should be properly backfilled. In particular, restrained-joint systems, which derive their stability from the interaction of the pipe and soil, should be backfilled prior to testing.

When testing valves, keep the valve closed when placing it in the trench. Do not backfill around valves before hydrostatic system test. Leave the valves exposed while the pipeline is being pressurized. Check to see that all valve joints and pressure containing bolting are tight. All appurtenances should be installed with appropriate thrust restraints. Generally, flanged valves are not recommended for buried service, as explained in AWWA C509-94. The improper installation of flanged valves can generate excessive stresses and cause valve failure.

Non-buried applications of push-on joint, mechanical joint, restrained joint, or ball and socket joint pipe, fittings, or valves, involve complex design and installation considerations. These applications include bridge crossings, installation on piers, etc. McWane, Inc. and Ransom Industries, Inc. do not make recommendations nor assume responsibility for

design or installation practices on such projects.

Applications involving flanged joint weld-on bosses also involve special design and installation considerations. Because this joint has no deflection capability, appurtenances attached in any direction must be completely immobilized to prevent overstressing the joint and joint failure due to thrust or other forces and pipeline settling. McWane, Inc. does not assume responsibility for design or installation practices in such applications. Flanged bosses should not be used at all in buried service, since complete immobilization is not generally possible.

When rubber-seated butterfly valves are used to isolate sections of line for test, it is important to realize that these valves are designed or factory adjusted to hold rated pressure only. Test pressures above valve-rated pressure may cause leakage past the rubber seat. In order to prevent time lost in searching for leaks, it is recommended that excavations for buried valves not be backfilled until after pressure tests have been made.

Seat leakage can result from foreign material in the line. If this occurs, open the valve 5-

10° to obtain high-velocity flushing action, then close. Repeat several times to clear seats for tight shutoff. Seat leakage can result from a rotational shift position of the disc with relation to the body seat.

Before conducting any pressure testing, air must be expelled completely from the section of piping under test. If permanent air vents are not located at all high points, appropriate measures shall be taken to ensure that air can be expelled as the line is filled with water. All deadends shall be equipped with suitable blow-off or venting devices.

All pressure testing of lines should be done hydrostatically. Do not use air-pressure to test pressurized water or sewer lines. **WARNING: THE USE OF AIR TO PRESSURE TEST A LINE, OR THE FAILURE TO REMOVE ALL AIR FROM A LINE PRIOR TO TESTING, CAN CAUSE EXPLOSIVE PRESSURES TO BUILD UP IN THE LINE THAT COULD CAUSE SERIOUS PERSONAL INJURY. NEVER USE COMPRESSED AIR TO PRESSURE TEST A LINE, AND ALWAYS MAKE CERTAIN THAT ALL AIR HAS BEEN REMOVED FROM THE LINE.**

BEFORE APPLYING WATER PRESSURE

It may be acceptable to test gravity sewer lines with low pressure air (5 psi or less) if proper procedures and precautions are followed. Consult all applicable standards and the project engineer before conducting any such testing.

Before performing any maintenance or repairs on pipe, valve, or hydrant, and before cutting into a line, make certain that all pressure has been released. Take care to insure that the pressure has been cut off upstream from the work area, and that it has been relieved by opening downstream valves or hydrants, as necessary. **WARNING: CUTTING INTO A PRESSURIZED LINE CAN CAUSE SERIOUS PERSONAL INJURY.** Where circumstances require tapping into a pressurized line, use only tapping sleeves designed for this purpose and only in accordance with the manufacturers instructions and applicable safety standards.

When flushing or flow testing either wet- or dry-barrel fire hydrants, a rigid diverter should never be used. The rigid diverter consists of a pipe screwed onto the hydrant outlet, extending out to a desired length, and bending up to 90° to change the direction of the water flow before discharging full flow into the atmosphere.

The water discharged from the diverter generates a pushing force (thrust) that could be very dangerous. The effect of this force is magnified by the distance from the outlet to the bend in the pipe, generating what can be a very tight torque on the hydrant due to the leverage. A rigid diverter can produce many hundreds of pounds of torque on the fire hydrant, potentially causing damage to the hydrant and connections leading to the hydrant. Maximum danger exists when the rigid diverter is installed in such a manner that the line pressure would create a sufficient torque to cause the hydrant head to unscrew from the standpipe, bury, or extension riser.

To prevent possible bodily injury, property damage or damage to the fire hydrant and its supporting structures, use only a diffuser or a flexible hose (properly restrained at the point of discharge) before flushing or flow testing.

FIGURE 1-LAYING CONDITIONS FOR DUCTILE IRON PIPE

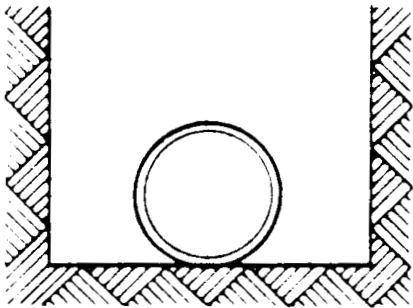

Type 1*
Flat-bottom trench.† Loose backfill.

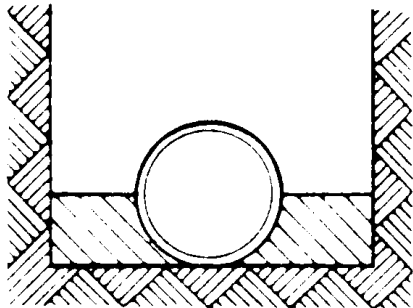

Type 2
Flat-bottom trench.† Backfill lightly consolidated to centerline of pipe.

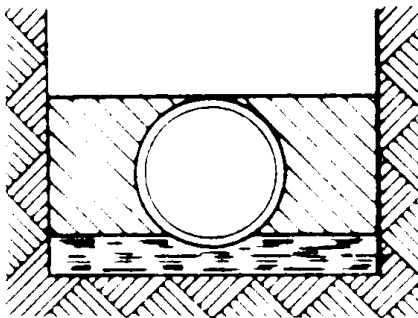

Type 3
Pipe bedded in 4 in. (100 mm) minimum of loose soil.++
Backfill lightly consolidated to top of pipe.

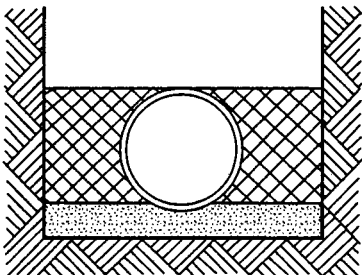

Type 4
Pipe bedded in sand, gravel, or crushed stone to depth of 1/8 pipe diameter, 4 in. (100 mm) minimum. Backfill compacted to top of pipe. (Approximately 80 percent Standard Proctor, AASHTO T-99.)

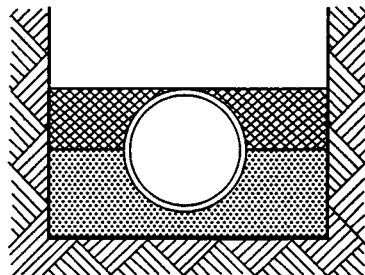

Type 5
Pipe bedded in compacted granular material to centerline of pipe. Compacted granular or select material++ to top of pipe. (Approximately 90 percent Standard Proctor, AASHTO T-99.)

*For 14 in. (355-mm) and large pipe, consideration should be given to the use of laying conditions other than type 1.

†"Flat-bottom" is defined as undisturbed earth.

++"Loose soil" or "select material" is defined as native soil excavated from the trench, free of rocks, foreign materials, and frozen earth.

PUSH-ON JOINT DUCTILE IRON PIPE

**INSTALLATION OF DUCTILE IRON WATER MAINS
AND THEIR APPURTENANCES**

SPIGOT STRIPE

The TYTON® Joint incorporates two spigot stripes painted on the plain end. The joint is fully assembled when the first stripe has disappeared inside the bell and the second stripe is approximately flush with the bell face.

The FASTITE® Joint incorporates a single stripe painted on the plain end. The joint is fully assembled when the stripe disappears inside the bell.

COLD WEATHER INSTALLATION

It is more difficult to position the gasket and assemble the joint in cold weather because of the stiffness of cold rubber. For ease of assembly, it is recommended that the gaskets be warmed up prior to placement in the bell. It should be noted that during cold weather it is far more difficult to effectively clean out the bell. Ice or frozen dirt in the gasket groove can prevent proper seating of the gasket.

LUBRICANT USAGE

PIPE SIZE	3	4	6	8	10	12	14	16	18	20	24	30	36
JOINTS PER LB. OF LUBRICANT	28	24	16	12	10	8	7	6	5	5	4	3	2.5

FIGURE 2 - PUSH-ON-JOINT ASSEMBLY

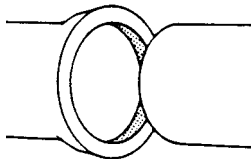
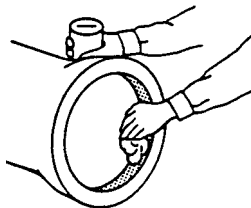
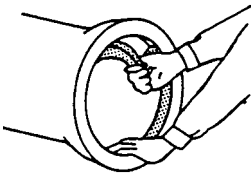

1. Thoroughly clean the groove and the bell socket of the pipe or fitting; also clean the plain end of the mating pipe. Using a gasket of the proper design for the joint to be assembled, make a small loop in the gasket and insert it in the socket, making sure the gasket faces the correct direction and that it is properly seated. Note: In cold weather, it is necessary to warm the gasket to facilitate insertion.

2. Apply lubricant to the gasket and plain end of the pipe in accordance with the pipe manufacturer's recommendations. Lubricant is furnished in sterile containers, and every effort should be made to protect against contamination of the container's contents. In some cases, manufacturer's recommendations on joint lubrication require that the gasket groove not be lubricated; in others, lubrication of the groove is necessary. It is important to follow the pipe manufacturer's instructions.

3. Be sure that the plain end is beveled; square or sharp edges may damage or dislodge the gasket and cause a leak. When pipe is cut in the field, bevel the plain end with a heavy file or grinder to remove all sharp edges. Push the plain end into the bell of the pipe. Keep the joint straight while pushing. Make deflection after the joint is assembled.

4. Small pipe can be pushed into the bell socket with a long bar. Large pipe requires additional power, such as a jack, lever puller, or backhoe. The supplier may provide a jack or lever puller on a rental basis. A timber header should be used between the pipe and jack or backhoe bucket to avoid damage to the pipe.

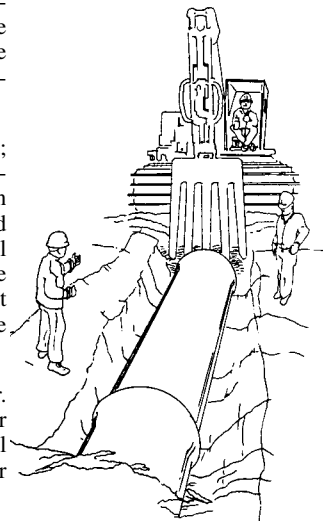
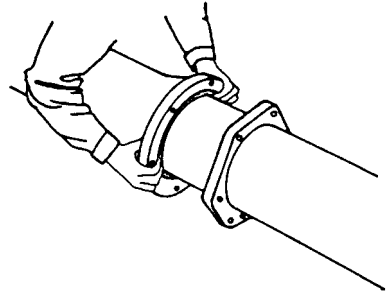
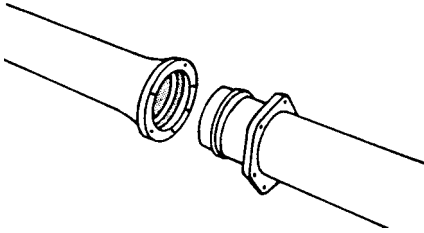
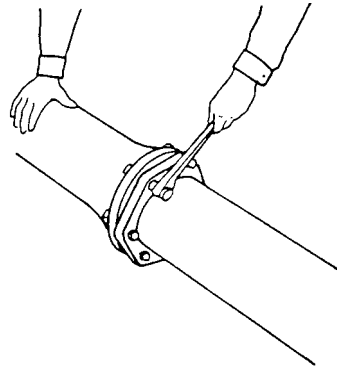

FIGURE 3 - MECHANICAL JOINT ASSEMBLY



1. Clean the socket and the plain end. Lubrication and additional cleaning should be provided by brushing both the gasket and plain end with soapy water or an approved pipe lubricant meeting the requirements of ANSI/AWWA C111/A21.11, just prior to slipping the gasket onto the plain end for joint assembly. Place the gland on the plain end with the lip extension toward the plain end, followed by the gasket with the narrow edge of the gasket toward the plain end.

2. Insert the pipe into the socket and press the gasket firmly and evenly into the gasket recess. Keep the joint straight during assembly.



3. Push the gland toward the socket and center it around the pipe with the gland lip against the gasket. Insert bolts and hand tighten nuts. Make deflection after joint assembly but before tightening bolts.

4. Tighten the bolts to the normal range of bolt torque as indicated below while at all times maintaining approximately the same distance between the gland and the face of the flange at all points around the socket. This can be accomplished by partially tightening the bottom bolt first, then the top bolt, next the bolts at either side, finally the remaining bolts. The use of a torque-indicating wrench will facilitate this procedure. Repeat the process until all bolts are within the appropriate range of torque. MJ pipe not available above 24”.

DO NOT OVERSTRESS BOLTS TO COMPENSATE FOR POOR INSTALLATION PROCEDURES

PIPE SIZE	BOLT DIA.	NUT ACROSS FLATS	WRENCH LENGTH	TORQUE RANGE FOOT POUNDS
3"	5/8"	1-1/16"	8"	45 TO 60
4"-24"	3/4"	1-1/4"	10"	75 TO 90
30"	1"	1-5/8"	14"	100 TO 120
36"	1"	1-5/8"	14"	100 TO 120

ASSEMBLY OF FIELD CUT PIPE

When pipe are cut in the field, the cut end may be readily conditioned so that it can be used to make up the next joint. The outside of the cut end should be beveled about 1/4-inch at an angle of about 30 degrees (Figure 1). This can be quite easily done with a coarse file or a portable grinder. The operation removes any sharp, rough edges which otherwise might injure the gasket.

When ductile iron pipe is to be cut in the field, the material should be ordered as "GAUGED FULL LENGTH". Pipe that is "gauged full length" is specially marked to avoid confusion. Ductile iron pipe selected for field cutting should also be field gauged in the location of the cut and found to be within the tolerances shown in Table 1. Full gauged pipe should not be cut any closer than 2 ft. of the face of the bell. In the field, a mechanical joint gland can be used as a gauging device.



Figure 1

Table 1. Suitable Pipe Diameters for Field Cuts and Restrained Joint Field Fabrication

NOMINAL PIPE SIZE IN.	MIN. PIPE DIAMETER IN.	MAX. PIPE DIAMETER IN.	MIN. PIPE CIRCUMFERENCE IN.	MAX. PIPE CIRCUMFERENCE IN.
3	3.90	4.02	12-1/4	12-5/8
4	4.74	4.86	14-29/32	15-9/32
6	6.84	6.96	21-1/2	21-7/8
8	8.99	9.11	28-1/4	28-5/8
10	11.04	11.16	34-11/16	35-1/16
12	13.14	13.26	41-9/32	41-21/32
14	15.22	15.35	47-13/16	48-7/32
16	17.32	17.45	54-13/32	54-13/16
18	19.42	19.55	61	61-13/32
20	21.52	21.65	67-19/32	68
24	25.72	25.85	80-13/16	81-7/32
30	31.94	32.08	100-11/32	100-25/32
36	38.24	38.38	120-1/8	120-9/16

ABOVE TABLE BASED ON ANSI/AWWA C151/A21.51 GUIDELINES FOR PUSH-ON JOINTS.

THE BACKHOE METHOD OF ASSEMBLY

A backhoe may be used to assemble pipe of intermediate and larger sizes. The plain end of the pipe should be carefully guided by hand into the bell of the previously assembled pipe. The bucket of the backhoe may then be used to push the pipe until fully seated. A timber header should be used between the pipe and backhoe bucket to avoid damage to the pipe.

INFORMATION REQUIRED WHEN ORDERING
OR REQUESTING QUOTATIONS**DUCTILE IRON PIPE**

Destination: Freight charges are normally included in the price of the material; therefore, it is necessary to advise the job location when requesting a quotation. Complete shipping instructions should be given when placing an order to expedite delivery.

Method of Shipment: Indicate whether truckload, less than truckload, trailer on flat car, picked up at plant, etc.

Size and Class: Give size, (nominal diameter and ANSI/AWWA Standard thickness (class 50, 52, CL150-200, etc.). If unknown, specify working pressure, depth of trench and laying condition. Flanged pipe thicknesses are governed by ANSI/AWWA C115/A21.15 Standard.

Joint Style: Indicate joint style, ie. Push-On, Mechanical, Restrained Push-On, Flanged, Ball and Socket.

Quantity: Give the length of pipe in feet required for each size, joint style and thickness class.

Coatings: All ductile pipe is normally furnished coated with an asphaltic coating which provides adequate protection in the majority of environments in the United States. Pipe can be furnished uncoated, or coated with a variety of shop primers designed to be compatible with specified final coatings.

Linings: Ductile iron pipe is normally furnished with standard cement lining conforming to ANSI/AWWA C104/A21.4 Standard.

Flanged pipe is normally furnished with cement lining. Special linings are available.

Pipe Lengths: All ductile iron pipe (except flanged) is regularly furnished as nominal 20 or 18 foot laying lengths. We reserve the right to furnish a limited number of shorter length pipe as permitted by ANSI/AWWA C151/A21.51. We also reserve the right to furnish a footage greater than the footage ordered to allow the use of full length pipe without cutting.

Flanged pipe is furnished to maximum length of 17'-6". Shorter lengths can be furnished as required.

Field Cuts: If 14" and larger ductile iron pipe is to be cut in the field, GAUGED-FULL-LENGTH should be ordered for this purpose. Normally, it is good practice to order one GAUGED-FULL-LENGTH pipe for each fitting and main line valve on the job. GAUGED-FULL-LENGTH pipe will be furnished with a special marking that easily identifies it. It is recommended that a mechanical joint gland be used as a gauge, slipping it along the barrel prior to starting a cut on any size pipe.

Flanges: Unless otherwise specified, all flanges will be faced and drilled to 125 lb. template as specified in ANSI B16.1 standard.

STANDARDIZED MECHANICAL JOINT FOR PIPE AND FITTINGS
ANSI/AWWA C111/A21.11 Standard

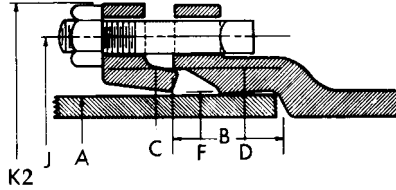

DIMENSION AND WEIGHTS

SIZE	DIMENSIONS-INCHES							BOLTS PER JOINT	BOLT SIZE	ACCESSORIES WGT. IN LBS. ††
	A	B	C	D	F	J	K2†			
3	3.96	2.50	4.84	4.94	4.06	6.19	7.69	4	5/8 X 3	7
4	4.80	2.50	5.92	6.02	4.90	7.50	9.12	4	3/4 X 3-1/2	10
6	6.90	2.50	8.02	8.12	7.00	9.50	11.12	6	3/4 X 3-1/2	16
8	9.05	2.50	10.17	10.27	9.15	11.75	13.37	6	3/4 X 4	25
10	11.10	2.50	12.22	12.34	11.20	14.00	15.62	8	3/4 X 4	30
12	13.20	2.50	14.32	14.44	13.30	16.25	17.88	8	3/4 X 4	40
14	15.30	3.50	16.40	16.54	15.44	18.75	20.25	10	3/4 X 4-1/2	45
16	17.40	3.50	18.50	18.64	17.54	21.00	22.50	12	3/4 X 4-1/2	55
18	19.50	3.50	20.60	20.74	19.64	23.25	24.75	12	3/4 X 4-1/2	65
20	21.60	3.50	22.70	22.84	21.74	25.50	27.00	14	3/4 X 4-1/2	85
24	25.80	3.50	26.90	27.04	25.94	30.00	31.50	16	3/4 X 5	105
30*	32.00	4.00	33.29	33.46	32.17	36.88	39.12	20	1 X 6	220
36*	38.30	4.00	39.59	39.76	38.47	43.75	46.00	24	1 X 6	285

*Available on fittings only.

†K2 is outside diameter of glands across bolt holes.

†† Shows total weight of gland, gasket, and a set of bolts required to complete one joint.

CAUTION: Bolts shown for sizes 8" and larger are not suitable for use with ANSI/AWWA C153/A21.53 Compact Fittings unless the threads are lengthened to compensate for the thinner Mechanical Joint Flanges on compact fittings. Dimensions of bolts for use with MJ compact fittings are shown on page 41.



CLOW DUCTILE IRON BALL AND SOCKET PIPE

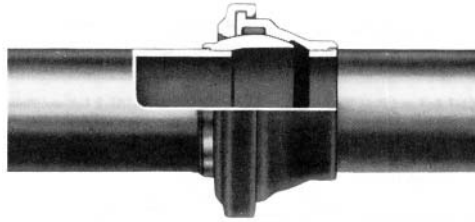

Clow Ball and Socket Pipe is a ball and socket type joint designed to meet the severe requirements for crossing rivers, streams and lakes, and for other uses where free turning deflection and a restrained joint are needed.

The joint is boltless. Restraint is provided by a bayonet-type locking of the retainer over the bell. Joint design assures uniform load distribution between the restraining components, even when the joint is fully deflected.

Each pipe consists of a bell, ball and retainer assembled on a centrifugally cast barrel. All pipe components are rugged, high-strength ductile iron. The barrel is cast of 60-42-10 ductile iron. The bell, ball and retainer are cast of 70-50-05 ductile iron.

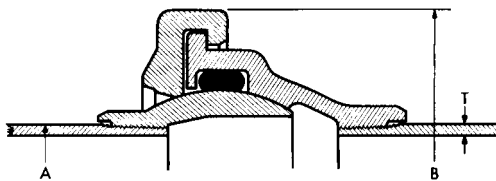

**F-141 Ball and Socket
DIMENSIONS AND WEIGHTS**

NOMINAL PIPE SIZE INCHES	A21.51 THICKNESS CLASS NUMBER	PRESSURE RATING PSI	DIMENSIONS-INCHES			PIPE BARREL LBS./ FOOT	WEIGHT OF FULL LENGTH PIPE* AS SHIPPED IN POUNDS
			T THICKNESS	A PIPE O.D.	B RETAINER O.D.		
6	55	350	.40	6.90	13.88	25.0	545
8	55	350	.42	9.05	16.63	34.8	770
10	55	350	.44	11.10	19.13	45.1	1005
12	55	350	.46	13.20	22.00	56.3	1270
14	56	350	.51	15.30	24.50	72.5	1655
16	56	350	.52	17.40	27.00	84.4	1990
18	56†	350	.53	19.50	30.00	96.7	2375
18	58	350	.59	19.50	30.00	107.3	2560
20	56†	350	.54	21.60	32.75	109.3	2810
20	59	350	.63	21.60	32.75	127.0	3110
24	56†	350	.56	25.80	38.25	135.9	3700
24	62	350	.74	25.80	38.25	178.3	4415
30	58†	250	.71	32.00	46.25	213.6	5855
30	61	250	.83	32.00	46.25	248.7	6435
36	57†	250	.78	38.30	54.25	281.3	8145
36	59†	250	.88	38.30	54.25	316.6	8725

†When full of air, pipe of this thickness will float unless weight is added.

*Weight is based on 18'0" nominal laying length. Minimum laying length is 1'0" for sizes 6 thru 12 in. and 3'0" for sizes 14 thru 36 in.

NOTE: While this joint provides full 15° free turning deflection with no reduction in the waterway, it is recommended that the "design" deflection be limited to 12° per joint.

**CLOW BALL AND SOCKET PIPE
CONNECTING PIECES**



F-141-1 Ball and Plain End



F-141-2 Bell and Plain End



F-141-11 Ball and Push-On Restrained Joint Plain End

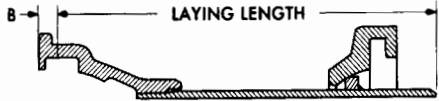

F-141-12 Bell and Push-On Restrained Joint Plain End



F-141-13 Ball and Restrained Joint Bell

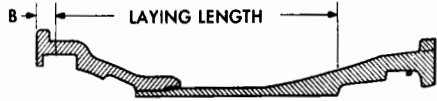

F-141-14 Bell and Restrained Joint Bell

DIMENSIONS AND WEIGHTS

NOM. PIPE SIZE	DIMENSIONS IN INCHES					APPROXIMATE WEIGHT-POUNDS*					
	THICKNESS		PLAIN END O.D.	A	B	F-141-1	F-141-2	F-141-11	F-141-12	F-141-13	F141-14
	A21.51 CLASS	WALL T									
6	55	.40	6.90	2-1/4	1	510	480	530	500	535	505
8	55	.42	9.05	2-5/8	1-1/8	720	675	755	710	760	715
10	55	.44	11.10	2-7/8	1-1/8	940	880	985	925	990	930
12	55	.46	13.20	3-1/4	1-1/8	1185	1100	1245	1160	1250	1165
14	56	.51	15.30	3-1/2	1-1/4	1545	1420	1630	1505	1620	1495
16	56	.52	17.40	3-3/4	1-1/4	1835	1680	1935	1780	1930	1770
18	56	.53	19.50	4-1/4	1-1/4	2185	1930	2330	2075	2300	2045
18	58	.59	19.50	4-1/4	1-1/4	2375	2115	2520	2260	2485	2225
20	56	.54	21.60	4-1/2	1-1/4	2585	2190	2755	2360	2715	2320
20	59	.63	21.60	4-1/2	1-1/4	2900	2495	3070	2665	3030	2625
24	56	.56	25.80	5-1/4	1-1/4	3365	2780	3655	3070	3510	2955
24	62	.74	25.80	5-1/4	1-1/4	4115	3510	4405	3800	4290	3590
30	58	.71	32.00	6-1/4	1-1/4	5350	4365	5810	4825	5520	4535
30	61	.83	32.00	6-1/4	1-1/4	5965	4965	6425	5425	6135	5135
36	57	.78	38.30	7-1/4	1-1/4	7450	5815	7635	6000	7805	6170
36	59	.88	38.30	7-1/4	1-1/4	8065	6415	8250	6600	8420	6770

*Weights shown are for 18 ft. laying lengths. Weights of shorter pieces can be determined by subtracting the appropriate barrel weight.

Maximum laying length is 18'0". Minimum laying length is 3'0".

Pipe can also be furnished Ball and MJ Bell (F-141-3), Bell and MJ Bell (F-141-4), Ball and Push-On Bell (F-141-5), Bell and Push-On Bell (F-141-6), Ball and Flange (F-141-9) or Bell and Flange (F-141-10).

Order must specify laying length of connecting pieces.

**CLOW BALL AND SOCKET PIPE
INSTALLATION DATA**

An installation procedure must be determined for each individual installation of Ball and Socket Pipe. Some successful methods for installing pipe across a river or lake are listed here as a guide.

Pulling into Position

Joints are assembled on shore. The river bank is trenched and sloped to prevent overdeflection of the joints during pulling. The lead pipe is usually a connecting piece which is capped or plugged to keep unwanted water out of the pipe and reduce the weight of the submerged pipe. A cable or harness is attached behind the first joint and the pulling cable secured to the lead line is pulled into place from the opposite shore.

Class 56 Ball and Socket Pipe in the 18" thru 24" sizes will float and require sinking to the bottom after pulling. Heavier classes are available for installations where flotation is not desired.

Laying from Barge

A crane mounted on a barge is used for handling the pipe.

A chute to guide the pipe into position is constructed and mounted on the barge.

The joints are assembled in this chute and guided into position on the bottom as the barge is moved ahead. The chute must be designed to prevent maximum deflection of the joints as they are guided into position.

Cofferdamming

A cofferdam is constructed to divert the flow of water and allow trenching by conventional means.

The pipe is then assembled in the trench in the river bottom.

Joint Deflection

It is recommended that installations be designed for a maximum joint deflection of 12 degrees. This design angle must also be considered when determining method of installation, slope of approaches or chutes, and the final contour of the installed pipe.

End Connections

The connection of F-141 Ball and Socket Pipe to the balance of the system can be accomplished in several ways. The end pieces can be furnished with any of the connections shown on page 21.

NOMINAL PIPE SIZE INCHES	A21.51 THICKNESS CLASS NUMBER	WALL THICKNESS IN INCHES	WEIGHT OF PIPE AS SHIPPED	WEIGHT OF FULL LENGTH PIPE UNDER WATER		MAXIMUM SAFE TENSION IN POUNDS††
				FULL OF AIR	FULL OF WATER	
6	55	.40	545	240	465	50,000
8	55	.42	770	240	655	70,000
10	55	.44	1005	220	860	95,000
12	55	.46	1270	155	1080	120,000
14	56	.51	1655	160	1410	145,000
16	56	.52	1990	45	1685	165,000
18	56	.53	2375	70	2015	195,000
18	58†	.59	2560	110	2170	195,000
20	56	.54	2810	200	2375	210,000
20	59†	.63	3110	100	2635	210,000
24	56	.56	3700	620	3110	260,000
24	62†	.74	4415	95	3715	260,000
30	58	.71	5855	900	4920	335,000
30	61	.83	6435	180	5360	335,000
36	57	.78	8145	1300	6880	400,000
36	59	.88	8725	725	7330	400,000

Weights above do not include lining.

† When full of air, pipe of this thickness will float unless weight is added.
 †† Maximum tension that can safely be applied to a single joint when pulling pipe into position or laying it from a barge.

**CLOW BALL AND SOCKET PIPE
INSTALLATION DATA**
*Continued***STANDARD PRACTICE**

While Clow Ball and Socket Pipe is regularly furnished in 18'0" nominal laying lengths, we reserve the right to furnish a limited percentage of shorter lengths. We will always ship a footage of pipe not less than the total ordered. We also reserve the right to furnish a total footage greater than the footage ordered to allow the use of full length pipe without cutting. Any exceptions to this standard practice must be clearly specified at the time of order.

Exact Laying Lengths: If any piece of pipe or length of piping must be furnished with an exact laying length, this must be specified. Random lengths will be used in making up exact laying lengths greater than 18 feet.

End Connections: Clow Ball and Socket Pipe can be furnished with the end connections listed on page 21. The type of end connection and length of connecting piece must be specified.

Accessories: Clow Ball and Socket Pipe are shipped with the retainer assembled on the pipe and secured to the ball end by hook bolts. Gaskets, lubricant, retainer locks and retainer lock pins are shipped in a separate container.



THRUST-LOCK™ BOLTLESS PUSH-ON RESTRAINED JOINT PIPE

Thrust-Lock™ joint combines the convenience of a push-on joint with the security of a positive lock restrained joint system.

Thrust-Lock's™ ease in assembly and disassembly and its joint deflection allowances make it one of the most cost-effective restrained joint systems available.

For field cuts 6" through 24", we offer the Thrust-Lock™ Field Cut restrained joint system. The Thrust-Lock™ Field Cut lock ring features stainless steel serrations welded to its interior serving to anchor the joint assembly. The Thrust-Lock™ Field Cut system features the strength, reliability and joint deflection offered by the Thrust-Lock™ joint.

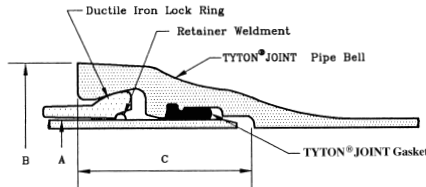

24" Thrust-Lock™ Boltless Restrained Joint

Thrust-Lock™ Boltless Restrained Joint

SIZE	PRESSURE RATING* PSI	DEFLECTION		A PIPE O.D.	B BELL O.D.	C SPIGOT SOCKET
		DEGREES	INCHES IN 18 FT.			
6	350	4	15	6.90	10.1875	5.000
8	350	4	15	9.05	13.1875	5.5625
10	350	4	15	11.10	15.1875	5.875
12	350	4	15	13.20	17.25	6.125
14	250, 300, 350	4	15	15.30	20.625	7.625
16	250, 300, 350	4	15	17.40	22.375	7.875
18	250, 300, 350	4	15	19.50	25.125	8.125
20	250, 300, 350	4	15	21.60	27.25	8.375
24	200, 250, 300, 350	4	15	25.80	31.5625	8.625
30	150, 200, 250	2	7	32.00	38.75	8.9375
36	150, 200, 250	1.5	5.5	38.30	43.82	8.9375

* In the 14" and larger sizes, pressure rating is limited to the rating of the pipe barrel thickness selected.

Note: See Page 25 for Thrust-Lock Joint™ assembly instructions.

**ASSEMBLY INSTRUCTIONS FOR
THRUST-LOCK™ FULL LENGTH BOLTLESS RESTRAINED JOINT PIPE**

- Step 1.** Lay pipe (A) with slot in 12 o'clock position.
- Step 2.** Clean socket and insert Tyton® Joint gasket (D).
- Step 3.** Slide locking ring (E) over weld (C).
- Step 4.** Clean spigot end of pipe.
- Step 5.** Lubricate exposed surface of gasket (D) and pipe spigot end (B) to retainer weldment (C).
- Step 6.** Make conventional push-on joint assembly ensuring that pipe is fully inserted, in alignment, until pipe bottoms out.
- Step 7.** Insert locking ring (E) with lug (G) positioned at 12 o'clock, working bottom of ring (E) into bottom of pipe (A) first.
- Step 8.** Turn ring (E) clockwise until lugs align. Use crowbar to tap on ring (E) slots if needed.
- Step 9.** Install anti-rotation wedges at 9 o'clock & 3 o'clock positions when pipe is used as carrier pipe within a casing.
- Step 10.** After completion of joint assembly, set deflection in joint if desired.

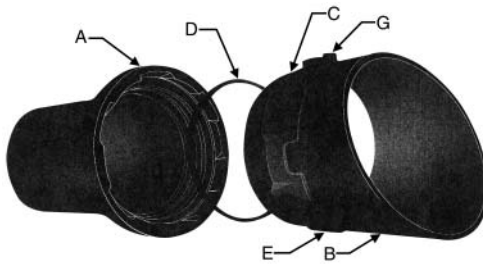

**ASSEMBLY INSTRUCTIONS FOR
THRUST-LOCK™ FIELD CUT BOLTLESS RESTRAINED JOINT PIPE**

- Step 1.** Lay pipe (A) with slot in 12 o'clock position.
- Step 2.** Clean socket and insert Tyton® Joint gasket (D).
- Step 3.** Cut and bevel pipe to required length. (Pipe selected should be checked for proper OD before field cut).
- Step 4.** Slide locking ring (E) onto spigot end of properly cut & beveled pipe (B).
- Step 5.** Clean spigot end of pipe(B).
- Step 6.** Lubricate exposed surface of gasket (D) and pipe spigot end (B) to socket depth only.
- Step 7.** Make conventional push-on joint assembly ensuring that pipe is fully inserted, in alignment, until pipe bottoms out.
- Step 8.** Insert locking ring (E) with lug (G) positioned at 12 o'clock, working bottom of ring (E) into bottom of pipe (A) first.
- Step 9.** Turn ring (E) clockwise until lugs align. Use crowbar to tap on ring (E) slots if needed.
- Step 10.** Screw bolt (F) into lug (G) & tighten to 65 ft. pounds torque.
- Step 11.** After completion of joint assembly, set deflection in joint if desired.

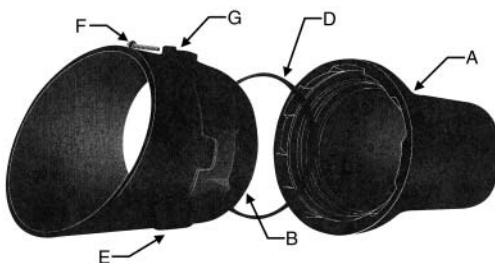

PUSH-ON RESTRAINED JOINT PIPE

**An All Ductile Iron, Restrained Push-On Joint
Designed for Hard Service Applications**



Push-On Restrained Joints are a positive means of restraining ductile iron pipe and fittings. The joint is completely boltless and is recommended for both exposed and underground installations with working pressures well in excess of normal service requirements.

The joint can be deflected after assembly to facilitate installation and accommodate earth settlement or movement. The design assures uniform load distribution between the restraining components when the joint is deflected. The unique design provides for quick and easy disassembly should the need arise.

The joint complies with all the push-on joint requirements of ANSI/AWWA C151/A21.51. For ANSI/AWWA C151/A21.51 thickness selection tables see page 226.

DIMENSIONS

NOMINAL PIPE SIZE INCHES	PRESSURE RATING* PSI	JOINT DEFLECTION		A PIPE O.D. INCHES	B RETAINER O.D. INCHES
		IN DEGREES	INCHES IN 18 FEET		
6	350	4	15	6.90	11.75
8	350	4	15	9.05	14.38
10	350	4	15	11.10	16.75
12	350	4	15	13.20	19.13
14	350	3	11	15.30	21.75
16	350	3	11	17.40	24.00
18	350	3	11	19.50	26.38
20	350	3	11	21.60	28.63
24	350	3	11	25.80	33.75
30	250	3	11	32.00	40.13

*In the 14" and larger sizes, pressure rating is limited to the rating of the pipe barrel thickness selected.

**CLOW SUPER-LOCK® “TYPE A” PUSH-ON RESTRAINED JOINT
F 217-W WELD-ON LOCK RING FOR FIELD-CUT PIPE**

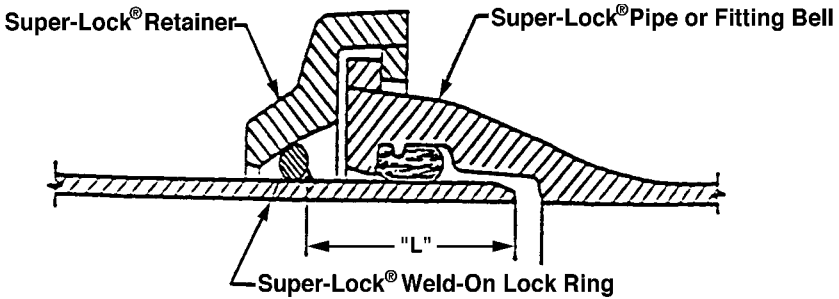

SIZE	PIPE O.D.	(1) PRESSURE RATING	RING DIA.	RETAINER WT. (LBS)	“L” +- 1/32 IN.
6	6.90	350	1/2	20	3-3/4
8	9.05	350	1/2	30	4
10	11.10	350	1/2	40	4
12	13.20	350	1/2	55	4
14	15.30	350	5/8	80	4-3/4
16	17.40	350	5/8	95	5
18	19.50	350	5/8	135	5-1/8
20	21.60	350	5/8	160	5-3/8
24	25.80	350	5/8	275	5-1/2
30	32.00	250	3/4	460	7-1/8

1. Pressure rating is limited to the rating of the pipe in the 14 in. & larger sizes.
2. For use with ductile iron pipe only.
3. Retainer is ductile iron. Lock ring is corrosion resistant alloy steel per ANSI A21.11.
4. Retainer, Retainer Lock, and Roll Pin furnished with Lock Ring.

Type A Ductile iron retainer has a spherical inside surface which engages the lock ring and segmented lugs which mate with lugs on the Super-Lock® bell. A retainer lock prevents rotation after assembly.

A lock-ring, factory-welded onto the plain end of pipe, anchors the retainer, preventing joint separation once the retainer is engaged with mating segmented lugs on the Super-Lock® bell.

Integrally cast ductile iron lugs on the bell engage the thick, strong interlocking members of the retainer to provide a positive locking device for the joint.

6” - 24” sizes are rated at 350 psi working pressure, providing an ample safety factor for both transmission and distribution service. (30” size is rated 250 psi working pressure.)

**CLOW SUPER-LOCK® “TYPE A” PUSH-ON RESTRAINED JOINT
F217-W WELD-ON LOCK RING**

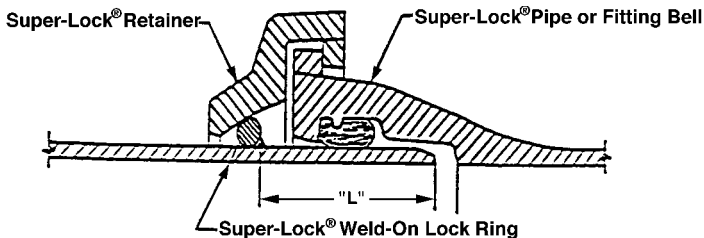

**INSTALLATION & WELDING PROCEDURES
CLOW PRODUCT DATA SHEET**

1. Cut the pipe to the required laying length. The cut must be smooth and lie in the plane that is square with the axis of the pipe. Use a welder's wrap or other device, if necessary, to mark the pipe prior to cutting.
2. Make certain the cut plain end is beveled for a distance of 3/8" to 1/2" along the barrel and smooth any sharp corners that could damage the gasket during joint assembly. (Proper beveling is very important and the use of a portable grinder is suggested).
3. Remove the asphaltic coating on the pipe in the area the retainer ring is to be welded - using a solvent wash or by burning with a torch. After the coating has been removed, grind the ring location to bright metal.
4. Slide the retainer casting on the pipe with the lugged side toward the plain end.
5. Slide the lock ring on the pipe and clamp the ring securely to the pipe in the location indicated below.

6 IN. PIPE: L=3-3/4"	18 IN. PIPE: L=5-1/8"
8-12 IN. PIPE: L=4"	20 IN. PIPE: L=5-3/8"
14 IN. PIPE: L=4-3/4"	24 IN. PIPE: L=5-1/2"
16 IN. PIPE: L=5"	30 IN. PIPE: L=7-1/8"

Tolerance on the "L" dimensions is +/- 1/32".

The ring must be installed in the plane that is square with the axis of the pipe and must be free from kinks.

Use three (3) locating bars shown on the following page. Place the first bar at one end of the ring and the other two bars farther around the pipe so that all bars are 6 to 10 inches apart. Clamp the bars securely by means of C-clamps or vise grips. As welding progresses around the pipe, the clamp is removed from the welded area and reclamped further around the pipe, maintaining two clamps ahead of the area being welded. (See illustration photo).

Make sure that the ends of the ring are clamped tight against the pipe before welding.

6. Weld the lock ring to the pipe barrel on the side next to the spigot end as illustrated above.

The weld electrode must be 55% nickel - Huntington Alloys Ni-Rod 55 or equal.

Apply a 5/16" fillet weld using 1/8" diameter electrode.

Start at the end of the ring and skip weld every 2 inches - progressing around the pipe to the other end of the ring. Make sure that both ends of the ring are welded.

The recommended amperage range for 1/8" diameter rod is 75 to 95 amps - using a D.C. arc welder employing reverse polarity.

Continued on Next Page

7. Thoroughly clean the weld and ring to remove all weld flux and splatter. Clean any weld splatter off the pipe spigot to assure proper joint assembly and gasket seating.
8. Paint the ring, weld and ground pipe surface with a smooth, uniform coat of brushable mastic, asphaltic base paint or machinery enamel.
9. Inspect the pipe lining for possible damage. Cement-mortar linings are normally not adversely affected by such welding procedures; however, if cement lining damage occurs, it should be patched in accordance with the procedures recommended in the ANSI/AWWA C104/A21.4 standard on cement-mortar fittings.
10. Assemble the Super-Lock® Joint per Clow assembly instructions.

Note: Refer to DIPRA publication “FIELD WELDING AND CUTTING OF DUCTILE IRON PIPE” for additional information.

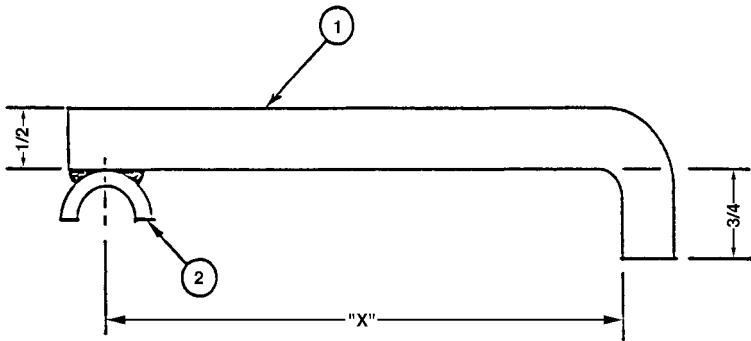

F 217-W WELD-ON LOCK RING LOCATING BAR

1. 1/2 x 1 STEEL: LENGTH = $(X + 1 - 1/2)$
2. “P” STEEL PIPE X 1” LG. (SPLIT)

PIPE SIZE	6	8-12	14	16	18	20	24	30
“X”	4	4-1/4	5-1/16	5-5/16	5-7/16	5-11/16	5-13/16	7-1/2
“P”	1/2 EX.-HVY.		1/2 STD. WT.				3/4 EX. HVY.	



DUCTILE IRON FLANGED JOINT PIPE
Meets all Requirements of ANSI/AWWA C115/A21.15 Standard
Pipe Barrel Meets all Requirements of
ANSI/AWWA C151/A21.51 Standard

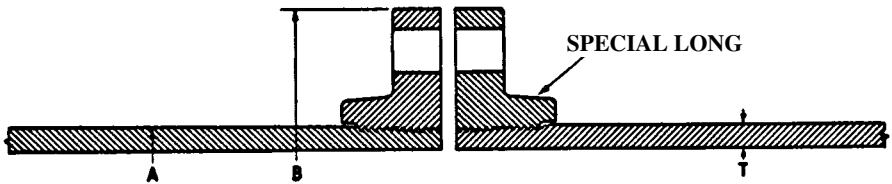

FLANGED JOINT PIPE

Flanged Joint Ductile Iron pipe is manufactured for water, steam, sewage, oil and other fluid lines where rigid joints are required. Flanged pipe is available in lengths up to 17'6" *maximum* and 19' 6" *maximum* for 3" and 4" pipe.

Ductile flanged pipe is made in accordance with ANSI/AWWA C115/A21.15 and has a pipe wall thickness that provides for adequate metal under the threads.

The bolt circle and bolt holes of the flanges conform to class 125 flanges shown in ANSI B16.1 and can be joined with Class 125 B16.1 or class 150 ANSI B16.5 (steel) flanges.

THIS PIPE SHOULD NOT BE THREADED OR FLANGED IN THE FIELD.

NOMINAL INSIDE DIAMETER INCHES	THICK. CLASS	RATED WORKING PRESSURE PSI	DIMENSIONS—INCHES			APPROXIMATE WEIGHT—POUNDS		
			T THICKNESS	A PIPE O.D.	B FLANGE O.D.	ONE FLANGE ONLY	PIPE BARREL PER FT.	17'-6" LENGTH* WITH FLANGES
3	53	250	.31	3.96	7.50	7	10.9	205
4	53	250	.32	4.80	9.00	13	13.8	270
6	53	250	.34	6.90	11.00	17	21.4	410
8	53	250	.36	9.05	13.50	27	30.1	580
10	53	250	.38	11.10	16.00	38	39.2	760
12	53	250	.40	13.20	19.00	58	49.2	980
14	53	250	.42	15.30	21.00	72	60.1	1195
16	53	250	.43	17.40	23.50	90	70.1	1405
18	53	250	.44	19.50	25.00	90	80.6	1590
20	53	250	.45	21.60	27.50	115	91.5	1830
24	53	250	.47	25.80	32.00	160	114.4	2320
30	53	250	.51	32.00	38.75	240	154.4	3180
36	53	250	.58	38.30	46.00	350	210.3	4380

*Rounded-off to nearest five pounds.

Foundry Practice

Power tightening the long hub flanges and refacing across the face of the flange and the end of the pipe allows the gasket to seat over the machined ends of the pipe to be joined. Thus, threads are not subjected to line pressure nor possible corrosive action of line contents. Pipe threads not engaged by the flange itself are covered by the long hub of the flange. A tolerance of plus or minus 1/8 inch shall be allowed on all face-to-face dimensions of both full length and short length flanged pipe. Cement lined flanged pipe may be substituted in lieu of asphaltic coated without prior notification.

Special Long Hub Flange

The Special Long Hub Flange is a special flange tapped for ductile iron pipe to outside diameters shown above with bolt holes in accordance with ANSI B16.1 125 pound template. **FLANGES OF DUCTILE IRON WILL ALWAYS BE FURNISHED WHEN DUCTILE IRON PIPE IS ORDERED.** Flange accessories must be ordered separately.

CLOW LONG-SPAN DUCTILE IRON PIPE
Mechanical Joint with O-Ring Rubber Gasket Flanged Joint
For Elevated Pipe Lines to Reduce Costs of Piers or Hangers

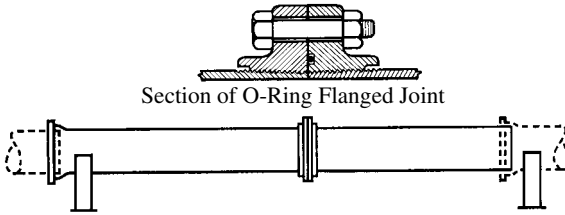

F-157

Mechanical Joint or Push-On Long-Span Pipe

Long-Span Pipe is a ductile iron multiple length pipe utilizing a special Clow-designed O-Ring Rubber Gasket Joint for the purpose of minimizing the number of piers required in elevated lines. 27-foot units are 18-foot lengths of Bell & Flanged, plus 9-foot lengths of Flanged and Plain End. 36-foot units are 18-foot lengths of Bell & Flanged and 18-foot lengths of Flanged & Plain End. 45-foot units are 18-foot Bell & Flanged, 17-foot Flanged & Flanged, and 10-foot Flanged & Plain End pieces.

Installation requires support immediately behind each bell, with allowance for expansion and contraction. Length tolerance of each unit is plus or minus 1/4-inch.

Pipe is shipped unassembled, with accessories packaged separately. Pipe conforms to ANSI A21.51. Flanges are 70-50-05 ductile iron using cadmium-plated bolts of the same size and number as ANSI B16.1 125 pound flanges.



Installation of Clow Long Span Pipe



Flanged Joint, showing Gasket in groove

DIMENSIONS AND WEIGHTS

NOMINAL PIPE SIZE INCHES	PRESSURE RATING PSI	UNIT LAYING LENGTH FEET*	WALL THICKNESS		DEFLECTION† AT CENTER OF SPAN IN INCHES	WEIGHT—POUNDS
			A21.51 CLASS	IN INCHES		PER UNIT TOTAL LENGTH EMPTY PIPE INCLUDING ACCESSORIES
6	250	27	54	.37	.53	690
8	250	27	54	.39	.34	965
10	250	27	54	.41	.24	1260
12	250	36	54	.43	.57	2080
14	250	36	54	.45	.45	2545
16	250	36	54	.46	.37	2990
18	250	36	55	.50	.29	3615
18	250	45	56	.53	.70	4890
20	250	36	55	.51	.25	4130
20	250	45	56	.54	.60	5595
24	250	36	56	.56	.18	5450
24	250	45	56	.56	.45	7045
30**	250	36	55	.59	.13	7210
30**	250	45	55	.59	.32	9395

*Plus or minus 1/4 inch. †With pipe full of water.

**30" size is furnished Push-On only. Other sizes are normally furnished with mechanical joint but can also be furnished Push-On.

Note: Unit laying lengths shorter than those listed above can also be furnished.

LININGS FOR DUCTILE IRON PIPE AND FITTINGS

CEMENT-MORTAR LINING

The first recorded installation of cement-mortar lined cast iron pipe was in 1922 at Charleston, S.C. Since that time, millions of feet of cement-mortar lined cast iron pipe have been installed around the country, helping to maintain high flow characteristics in pipelines carrying aggressive water.

Over the years, improvements have been made in application techniques, the quality of the cement and the curing process. Today, virtually all ductile iron pipe is furnished with this low cost and very effective lining.

We offer a full line of cement-mortar lined pipe and fittings, all in accordance with the requirements of ANSI/AWWA C104/A21.4 Standard.

Generally, cement-mortar linings are not suitable for wastewater applications. Certain industrial wastes and septic sewage can quickly attack the cement causing it to fail. For those installations where these types of waste will be conveyed, we offer Protecto 401 Ceramic Epoxy lining that will provide trouble free service.

PROTECTO 401

Protecto 401 lined ductile iron pipe and fittings provide the maximum protection and the strength necessary to do the job in tough sewer pipe applications. Protecto 401 has successfully been used in hundreds of sanitary sewer applications and has been proven with both laboratory testing and years of actual sewer service on all sizes of ductile iron pipe and fittings. Protecto 401 Ceramic Epoxy Lining was designed and is used as a protection for sanitary sewer conduits.

POLYETHYLENE ENCASEMENT FOR DUCTILE IRON PIPE IN CORROSIVE SOILS

Meets all Requirements of ANSI/AWWA C105/A21.5 Standard

Polyethylene encasement is a proven method of protecting ductile iron pipe in areas of severely corrosive soil. The protection is provided by isolating the pipe from the corrosive environment. A completely air and water-tight enclosure is not necessary.

The dielectric capability of polyethylene also provides shielding against stray direct current at most levels encountered in the field.

Eight (8) mil thick polyethylene tube is furnished in the flat tube widths listed.

More detailed information on polyethylene encasement is available upon request. Both material and installation procedures are specified in ANSI/AWWA C105/A21.5.

RECOMMENDED POLYETHYLENE FLAT TUBE WIDTH BY PIPE SIZE

NOMINAL PIPE SIZE INCHES	FLAT TUBE WIDTH – INCHES (LAYFLAT SIZE)	
	PUSH-ON & MJ	RESTRAINED JOINT
3	14	–
4	16	–
6	16	20
8	20	24
10	24	30
12	27	34
14	30	37
16	34	41
18	37	45
20	41	54
24	54	54
30	67	67
36	81	81

PROVISION FOR ELECTRICAL THAWING

In order to provide electrical conductivity from one rubber gasket pipe joint to another for the purpose of thawing frozen water mains, some specifiers require that ductile iron pipe be furnished with a device that will be able to provide such conductivity. The accessories and methods indicated below provide such conductivity for both Push-On Joints and Mechanical Joints.

ONE WORD OF CAUTION: Electrically discontinuous rubber gasket joints effectively inhibit the accumulation of stray direct current on ductile iron pipe. An accumulation of stray current can result in electrolytic corrosion of the pipeline. The use of joint bonding devices to allow electrical thawing can, therefore, increase the susceptibility of the pipe to damage from this type of corrosion.

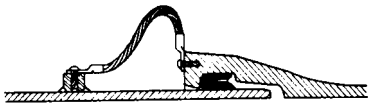
CABLE BOND CONDUCTOR

Assembled Installation, Push-On Joint

Cable Bond provides positive electrical conductivity across the joints of both Push-On and Mechanical Joint pipe and fittings. The copper cable will carry 500-600 amps for an extended period of time. The cable is sufficiently flexible to simplify assembly and to withstand ground and pipe movement after installation. Easy to install, it makes a positive, lasting connection. Detailed information and assembly instructions will be furnished upon request.

SERRATED SILICON BRONZE WEDGES

for Push-On Joint



Serrated Wedge

When so specified, serrated silicon bronze wedges are provided for electrical thawing: two per joint, for 3" through 12" pipe; four for larger diameter pipe. Each wedge is driven into the opening between the plain end and the bell until snug. When four wedges are used, they are inserted side by side, in pairs.

WARNING

Electrical thawing of buried pipes should never be attempted by inexperienced persons. The large currents necessary to effectively thaw a frozen pipe can cause serious damage to electrical wiring systems that are grounded to the buried pipes. In addition, there is a serious risk of personal injury or electrocution if proper precautions are not taken.

MAKING OFFSETS ON THE JOB

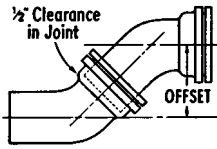

Mechanical Joint

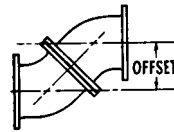

Flanged Joint*

Using Two Bends – Offset in Inches

NOMINAL DIAMETER INCHES	C111/A21.1 MECHANICAL JOINT			C110/A21.10 OR B16.1			
	MECHANICAL JOINT			SHORT RADIUS			LONG
	90°	45°	22-1/2°	90°	45°	22-1/2°	90°
3	19.50	10.25	5.56	11.00	4.24	2.30	15.50
4	21.50	11.69	6.31	13.00	5.66	3.06	18.00
6	24.50	13.06	7.06	16.00	7.07	3.83	23.00
8	26.60	13.75	7.50	18.00	7.78	4.21	28.00
10	30.50	15.19	8.25	22.00	9.19	4.98	33.00
12	32.50	16.62	9.00	24.00	10.61	5.74	38.00
14	36.50	16.62	8.99	28.00	10.61	5.74	43.00
16	38.50	17.32	9.38	30.00	11.31	6.12	48.00
18	41.50	18.03	9.76	33.00	12.02	6.51	53.00
20	44.50	19.45	10.52	36.00	13.44	7.27	58.00
24	52.50	21.57	11.67	44.00	15.56	8.42	68.00
30	58.50	27.23	14.73	50.00	21.22	11.48	...

*No allowance is made in offset figures for gasket thickness.

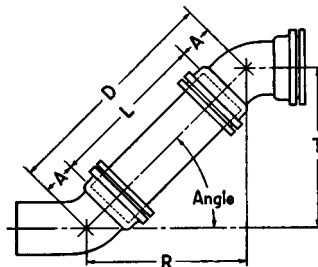

DETERMINING LENGTH OF PIPE IN OFFSET JOINTS

ANGLE	D EQUALS	D EQUALS	L† EQUALS
45°	T X 1.414	T X 1.000	D-2A
22-1/2°	T X 2.613	T X 2.414	D-2A
11-1/4°	T X 5.126	T X 5.027	D-2A

†Cut the pipe somewhat shorter than theoretical to allow for some slight clearance in the joints.

Problem

A 14-inch Mechanical Joint line is to be offset 12 feet on an angle of 45-degrees using two Mechanical Joint bends. What is the laying length (L) of pipe required to make the connection between the two bends?

Solution

$D = 12'0'' \times 1.414 = 16.968'$ $R = 12'0'' \times 1.000 \times 12.000'' A = 7.5'' = .625'$ $A + A = 1.250'$
 $L = 16.968' - 1.250' = 15.718'$ or approximately 15'- 5/8" laying length of connecting pipe.

**SECTION I DUCTILE IRON PIPE
INDEX**

A	
Advancement of Ductile Iron Pipe	5
Assembly Instructions:	
Ball and Socket Pipe	22
Field-Cut Pipe	17
Mechanical Joint	16
Push-On	15
Applicable Standards for Pipe (ANSI/AWWA Standards)	223
B	
Back-Hoe Method of Assembly	17
Ball and Socket Pipe (River Crossing):	
Connecting Pieces	21
Dimensions	20
Installation Data	22-23
Bronze Wedges for Thawing Pipe	32
C	
Cable Bond Electrical Thawing Conductor	32
Cement Lining for Pipe Fittings	31
Clow Super-Lock Push-On	25-28
Cold Weather Installation	15
Connecting Pieces - Ball and Socket Pipe	21
Corrosive Soil Protection for Pipe and Fittings	31
D	
Deflection Data	224
Ductile Iron Pipe:	
Ball and Socket (River Crossing)	20-23
Clow Super-Lock® Push-On	25-28
Flanged	29
Long-Span	30
Mechanical Joint	10-11
Push-On (Pressure Classes)	7
Push-On (Special Classes)	8-9
Restrained Push-On	24-28
E	
Electrical Thawing - Provisions	32
Encasement, Polyethylene	31
F	
F 217-W Weld-On Lock Ring	26-28
Field-Cut Pipe Assembly	17
Flanged Pipe	29
H	
History of Pipe Standards	6
I	
Installation of Water Mains & Appurtenances	12-16
L	
Laying Conditions for Pipe	14
Linings for Ductile Iron Pipe and Fittings:	
Cement Mortar Lining	31
Polyethylene Encasement	31
Protecto 401	31

Locating Bar for F 217-W Weld-On	
Lock Ring	28
Long-Span Pipe	30
Lubricant for Push-On Joints	15

M

Making Offsets on the Job	33
Maximum Deflections of M.J. Pipe	11
Maximum Deflections of Push-On Joint Pipe	224
McWane, Inc. Division Offices	i
Mechanical Joint Pipe:	
Dimensions and Weights	10-11
Installation	16
Standardized Dimensions	19

O

Offsets — Flanged and Mechanical Joint	33
Ordering Information	18

P

Pipe, Ductile Iron:	
Ball and Socket (River Crossing)	20-23
Clow Super-Lock® Push-On	25-28
Flanged	29
Long Span	30
Mechanical Joint	10-11
Push-On (Pressure Classes)	7
Push-On (Special Classes)	8-9
Restrained Push-On	24-28
Polyethylene Encasement	31
Protecto 401	31
Push-On:	
Dimensions & Weights (Pressure Classes)	7
Dimensions & Weights (Special Classes)	8-9
Installation	15

R

Ransom Industries, Inc. Division Offices	i
Restrained Push-On	24-28
River Crossing Pipe - Installation Data	22-23

T

Terms	ii
Thrust-Lock™ Boltless Push-On R.J.	24

W

Warning — Electrical Thawing	32
Warranty	ii

FITTINGS

CLOW WATER SYSTEMS COMPANY

TYLER PIPE

UNION FOUNDRY COMPANY

Not all items shown are available from each division.

Other sizes of certain fittings are available. Call Clow Water Systems Flange and Fabricated Sales Office for further information.

This page intentionally left blank.

PIPE
ECONOMY

CONTENTS

Mechanical Joint Class 350 — C153 SSB/Compact	43
Mechanical Joint C110 Full Body	52
Flanged Fittings C110	64
Union-tite Push-On C153	72
Clow Super-Lock® Fittings	80
Compact Flanged Fittings	84
Valve Boxes	87
Fixed and Adjustable Risers	93
Meter Covers	100
Mechanical Joint Retainer Glands	101
Mechanical Joint Tapping Sleeves	102
Index	103

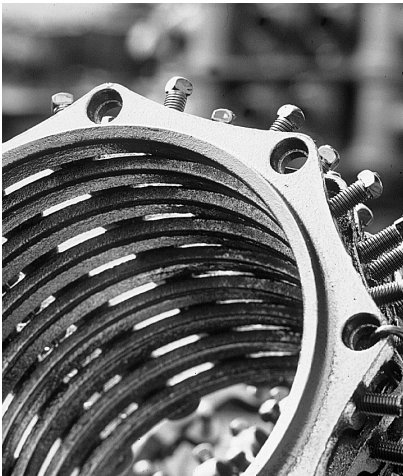

This page intentionally left blank.

PIPE
ECONOMY

**MECHANICAL JOINT DUCTILE IRON
CLASS 350 FITTINGS
ANSI/AWWA C153 / A21.53
SSB/COMPACT**

SAMPLE SPECIFICATIONS: 3" THRU 24" MECHANICAL JOINT DUCTILE IRON FITTINGS shall be produced in accordance with all applicable terms and provisions of ANSI/AWWA C153/A21.53 and ANSI/AWWA C111/A21.11.

NOTE: Fittings are cement-lined and seal coated in accordance with ANSI/AWWA C104/A21.4; also available double cement lined or bare. See list price sheet for details.

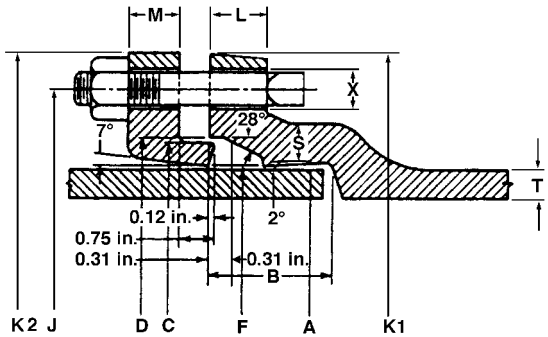

JOINT DIMENSIONS IN INCHES

SIZE	A DIA.	B	C DIA.	D DIA.	F. DIA.	J DIA.	K1 DIA.	K2 DIA.	L	M	S	T	X DIA.	MINIMUM BOLT SIZE	No.
3	3.96	2.50	4.84	4.94	4.06	6.19	7.62	7.69	.58	.62	.39	.33	3/4	5/8 X 3	4
4	4.80	2.50	5.92	6.02	4.90	7.50	9.06	9.12	.60	.75	.39	.34	7/8	3/4 X 3-1/2	4
6	6.90	2.50	8.02	8.12	7.00	9.50	11.06	11.12	.63	.88	.43	.36	7/8	3/4 X 3-1/2	6
8	9.05	2.50	10.17	10.27	9.15	11.75	12.31	13.37	.66	1.00	.45	.38	7/8	3/4 X 3-1/2	6
10	11.10	2.50	12.22	12.34	11.20	14.00	15.62	15.62	.70	1.00	.47	.40	7/8	3/4 X 3-1/2	8
12	13.20	2.50	14.32	14.44	13.30	16.25	17.88	17.88	.73	1.00	.49	.42	7/8	3/4 X 3-1/2	8
14	15.30	3.50	16.40	16.54	15.44	18.75	20.31	20.25	.79	1.25	.56	.47	7/8	3/4 X 4	10
16	17.40	3.50	18.50	18.64	17.54	21.00	22.56	22.50	.85	1.31	.57	.50	7/8	3/4 X 4	12
18	19.50	3.50	20.60	20.74	19.64	23.25	24.83	24.75	1.00	1.38	.68	.54	7/8	3/4 X 4	12
20	21.60	3.50	22.70	22.84	21.74	25.50	27.08	27.08	1.02	1.44	.69	.57	7/8	3/4 X 4	14
24	25.80	3.50	26.90	27.04	25.94	30.00	31.58	31.50	1.02	1.56	.75	.61	7/8	3/4 X 4-1/2	16

BENDS

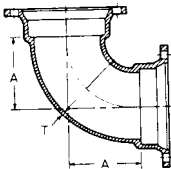

90° Bends (1/4)

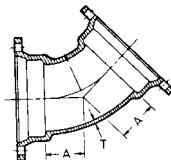

45° Bends (1/8)

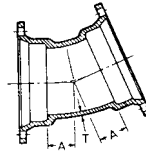

22-1/2° Bends (1/16)

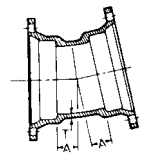

11-1/4° (1/32)

SIZE	MINIMUM DIMENSIONS			MINIMUM DIMENSIONS		MINIMUM DIMENSIONS		MINIMUM DIMENSIONS	
	T	A	WEIGHT	A	WEIGHT	A	WEIGHT	A	WEIGHT
3	.34	3.5	20	2.00	16	1.50	15	1.25	15
4	.35	4.0	26	2.49	22	1.75	21	1.50	18
6	.37	6.0	43	3.25	36	2.25	34	1.50	30
8	.39	7.0	64	4.00	55	2.50	46	1.75	44
10	.41	7.5	96	5.01	74	3.00	67	2.00	61
12	.43	9.0	122	5.98	111	3.50	80	2.25	74
14	.51	12.0	220	5.50	164	3.75	148	2.59	93
16	.52	13.0	264	5.98	202	3.98	178	2.62	158
18	.59	15.5	410	6.50	289	7.50	292	7.50	287
20	.60	17.0	505	7.00	348	8.50	364	8.50	346
24	.62	20.0	664	7.50	475	9.00	460	9.00	457

**MECHANICAL JOINT DUCTILE IRON
CLASS 350 FITTINGS
ANSI/AWWA C153/A21.53
SSB/COMPACT**

BENDS

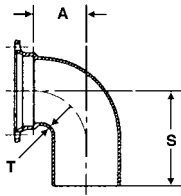

90° MJ x PE Bend
(1/4)

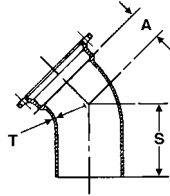

45° MJ x PE Bend
(1/8)

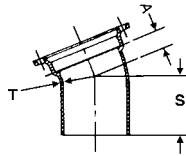

22-1/2° MJ x PE Bend
(1/16)

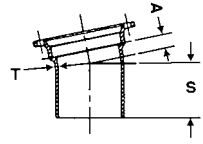

11-1/4° MJ x PE Bend
(1/32)

SIZE	MINIMUM DIMENSIONS				MINIMUM DIMENSIONS			MINIMUM DIMENSIONS			MINIMUM DIMENSIONS		
	T	A	S	WEIGHT	A	S	WEIGHT	A	S	WEIGHT	A	S	WEIGHT
3	.34	3.5	9.0	19	2.0	7.5	16	1.50	7.00	16	1.25	6.75	15
4	.35	4.0	9.5	25	2.5	8.0	22	1.75	7.25	19	1.50	7.05	19
6	.37	6.0	11.5	43	3.25	8.75	34	2.25	7.75	33	1.50	7.05	29
8	.39	7.0	12.5	61	4.0	9.50	53	2.50	8.00	46	1.75	7.25	41
10	.41	7.5	13.0	105	5.0	10.50	72	3.00	8.50	64	2.00	7.50	55
12	.43	9.0	14.5	124	6.0	11.44	98	3.50	9.00	81	2.25	7.75	70
14	.51	12.0	20.0	220	5.5	13.40	148	3.75	11.63	133	2.59	10.59	122
16	.52	13.0	21.0	254	6.0	13.87	192	3.98	11.88	181	2.62	10.50	148

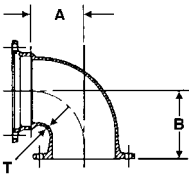

90° MJ x FE Bend*
(1/4)

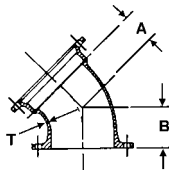

45° MJ x FE Bend*
(1/8)

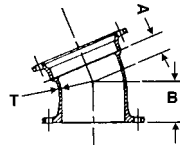

22-1/2° MJ x FE Bend*
(1/16)

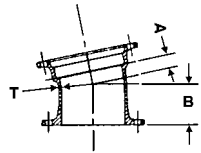

11-1/4° MJ x FE Bend*
(1/32)

SIZE	MINIMUM DIMENSIONS				MINIMUM DIMENSIONS			MINIMUM DIMENSIONS			MINIMUM DIMENSIONS		
	T	A	B	WEIGHT	A	B	WEIGHT	A	B	WEIGHT	A	B	WEIGHT
3	.34	3.5	5.5	21
4	.35	4.0	6.5	28	2.5	4.0	27	1.75	4.0	19	1.5	4.0	19
6	.37	6.0	8.0	44	3.25	5.0	36	2.25	5.0	41	1.5	5.0	30
8	.39	7.0	9.0	66	4.25	5.5	54	2.5	5.5	50	1.75	5.5	43
10	.41	7.5	11.0	115	5.0	6.5	82	3.0	6.5	90	2.0	6.5	75
12	.43	9.0	12.0	141	6.0	7.5	112	3.5	7.5	100	2.25	7.5	88
14	.51	12.0	14.0	227	5.5	8.5	207
16	.52	13.0	15.0	280	6.0	9.5	290

*Not included in ANSI/AWWA C153/A21.53. Pressure rating 250 psi.

**MECHANICAL JOINT DUCTILE IRON
CLASS 350 FITTINGS
ANSI/AWWA C153/A21.53
SSB/COMPACT**

TEES

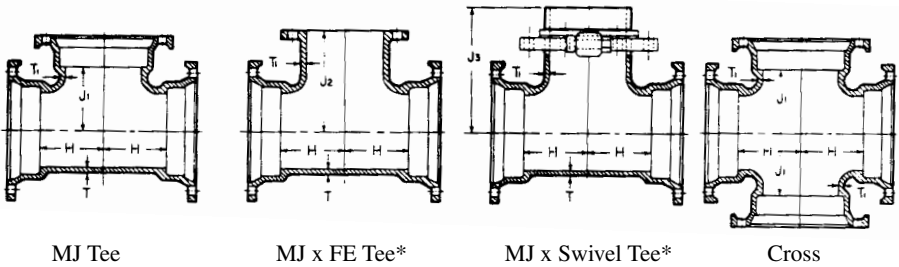

SIZE	MINIMUM DIMENSIONS						MINIMUM WEIGHTS			
	T	T1	H	J1	J2	J3	MJ	MJ x FE	MJ x S†	Cross
3	.34	.34	3.5	3.50	5.5	...	26	26	...	33
4 X 3	.35	.34	3.5	3.50	6.5	...	32	34	...	38
4	.35	.35	4.0	4.00	6.5	...	35	38	...	42
6 X 3	.37	.34	3.5	4.00	6.5	...	47	51
6 X 4	.37	.35	4.0	5.00	8.0	...	51	54	...	62
6	.37	.37	5.0	5.00	8.0	10.50	60	62	70	80
8 X 3	.39	.34	4.0	6.50	9.0	...	68
8 X 4	.39	.35	4.5	6.50	9.0	...	71	72	...	84
8 X 6	.39	.37	5.5	6.50	9.0	11.50	80	83	88	105
8	.39	.39	6.5	6.50	9.0	10.50	90	93	105	111
10 X 3	.41	.34	4.0	7.50	11.0	...	83
10 X 4	.41	.35	4.0	7.50	11.0	...	83	89	...	98
10 X 6	.41	.37	5.0	7.50	11.0	13.00	93	107	107	110
10 X 8	.41	.39	6.5	7.50	11.0	12.50	111	115	129	138
10	.41	.41	7.5	7.50	11.0	...	120	130	...	155
12 X 3	.43	.34	4.0	8.75	12.0	...	100
12 X 4	.43	.35	4.0	8.75	12.0	...	105	115	...	115
12 X 6	.43	.37	5.0	8.75	12.0	14.25	115	120	128	129
12 X 8	.43	.39	6.5	8.75	12.0	13.50	123	146	149	258
12 X 10	.43	.41	7.5	8.75	12.0	...	153	161	...	180
12	.43	.43	8.75	8.75	12.0	...	165	187	...	212
14 X 6	.51	.44	6.5	10.50	12.5	14.00	183	205	182	210
14 X 8	.51	.45	7.5	10.50	14.0	...	206	231
14 X 10	.51	.46	8.5	10.50	12.5	...	229	226	...	255
14 X 12	.51	.47	9.5	10.50	12.5	...	235	238	...	269
14	.51	.51	10.5	10.50	14.0	...	281	285	...	299
16 X 6	.52	.45	6.5	11.50	13.5	15.00	229	213	234	250
16 X 8	.52	.46	7.5	11.50	13.5	...	248	249	...	264
16 X 10	.52	.47	8.5	11.50	13.5	...	265	287	...	286
16 X 12	.52	.48	9.5	11.50	13.5	...	281	312	...	310
16 X 14	.52	.51	10.5	11.50	15.0	...	317	348	...	363
16	.52	.52	11.5	11.50	15.0	...	323	324	...	410

†Weights include swivel gland

* Not included in ANSI/AWWA C153/A21.53. Pressure rating on flange joint is 250 psi.

**MECHANICAL JOINT DUCTILE IRON
CLASS 350 FITTINGS
ANSI/AWWA C153/A21.53
SSB/COMPACT**

TEES

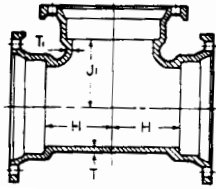

MJ Tee

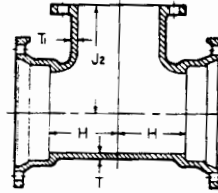

MJ x FE Tee*

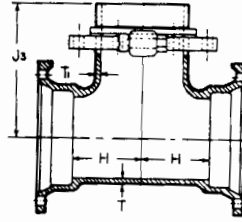

MJ x Swivel Tee*

SIZE	MINIMUM DIMENSIONS						MINIMUM WEIGHTS		
	T	T1	H	J1	J2	J3	MJ	MJ x FE	MJ x S†
18 X 6	.59	.44	6.5	12.5	14.5	16.13	275	261	278
18 X 8	.59	.45	7.5	12.5	14.5	...	280	351	...
18 X 10	.59	.47	8.5	12.5	286
18 X 12	.59	.49	9.5	12.5	370
18 X 14	.59	.56	10.5	12.5	415
18 X 16	.59	.57	11.5	12.5	445
18	.59	.59	12.5	12.5	490
20 X 6	.60	.44	7.0	14.0	16.0	17.5	335	341	358
20 X 8	.60	.45	8.0	14.0	383
20 X 10	.60	.47	9.0	14.0	410
20 X 12	.60	.49	10.0	14.0	432
20 X 14	.60	.56	11.0	14.0	475
20 X 16	.60	.57	12.0	14.0	530
20 X 18	.60	.59	13.0	14.0	560
20	.60	.60	14.0	14.0	605
24 X 6	.62	.44	7.0	16.0	18.0	19.5	454	460	458
24 X 8	.62	.45	8.0	16.0	475
24 X 10	.62	.47	9.0	16.0	505
24 X 12	.62	.49	10.0	16.0	18.0	...	545	580	...
24 X 14	.62	.56	11.0	16.0	585
24 X 16	.62	.57	12.0	16.0	19.5	...	625	744	...
24 X 18	.62	.59	13.0	16.0	675
24 X 20	.62	.60	15.0	17.0	740
24	.62	.62	17.0	17.0	830

†Weights include swivel gland

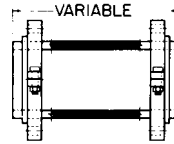
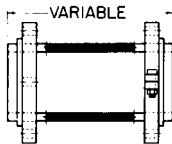

SWIVEL X SOLID ADAPTER WITH SWIVEL GLAND*			SWIVEL X SWIVEL ADAPTER WITH SWIVEL GLANDS (2)*		
SIZE BY LAYING LENGTH	WALL THICKNESS	WEIGHT	SIZE BY LAYING LENGTH	WALL THICKNESS	WEIGHT
6 X 13	.37	33	6 X 13	.37	28
6 X 18	.37	56	6 X 18	.37	49
6 X 24	.37	60	6 X 24	.37	52
8 X 12	.37	52			

* Not included in ANSI/AWWA C153/A21.53. Pressure rating on flange joint is 250 psi.

**MECHANICAL JOINT DUCTILE IRON
CLASS 350 FITTINGS
ANSI/AWWA C153/A21.53
SSB/COMPACT**

WYES

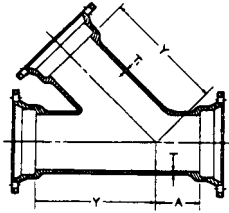

REDUCERS

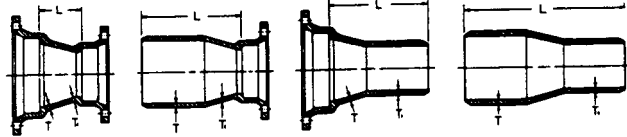

**Wyes*

MJ x MJ

SEB

LEB

PE x PE

MINIMUM DIMENSIONS					MINIMUM WEIGHTS
SIZE	A	Y	T	T1	
3	2.0	7.5	.34	.34	30
4 X 3	1.0	8.5	.35	.34	40
4	2.5	8.5	.35	.35	45
6 X 4	1.5	11.0	.37	.35	58
6	3.0	12.0	.37	.37	82
8 X 4	0.5	13.0	.39	.35	77
8 X 6	2.0	14.5	.39	.37	111
8	3.5	15.0	.39	.39	117
10 X 4	0.0	15.0	.41	.35	111
10 X 6	1.0	16.0	.41	.37	126
10 X 8	2.5	17.0	.41	.39	160
10	3.5	18.0	.41	.41	184
12 X 4	0.0	16.0	.43	.35	150
12 X 6	1.5	18.5	.43	.37	178
12 X 8	1.5	18.5	.43	.39	188
12 X 10	3.0	20.0	.43	.41	223
12	4.5	20.0	.43	.43	249
14	6.0	25.0	.51	.51	465
16 X 6	0.0	21.0	.52	.45	300
16 X 8	0.5	22.5	.52	.46	327
16 X 12	3.5	25.0	.52	.48	447
16	6.5	28.0	.52	.52	575

*Not included in ANSI/AWWA C153/A21.53.

MINIMUM DIMENSIONS							MINIMUM WEIGHTS			
SIZE	T	T1	MJ	SEB	LEB	PE	MJ	SEB	LEB	PE
			L	L	L	L				
4 X 3	.35	.34	3.0	8.5	8.5	14.0	18	17	18	15
6 X 3	.37	.34	5.0	10.5	10.5	16.0	26	25	27	20
6 X 4	.37	.35	4.0	9.5	9.5	15.0	27	26	26	22
8 X 4	.39	.35	5.0	10.5	10.5	16.0	36	33	36	32
8 X 6	.39	.37	4.0	9.5	9.5	15.0	38	36	36	33
10 X 4	.41	.35	7.0	12.5	12.5	18.0	47	44	43	...
10 X 6	.41	.37	5.0	10.5	10.5	16.0	47	48	52	46
10 X 8	.41	.39	4.0	9.5	9.5	15.0	54	49	51	47
12 X 4	.43	.35	9.0	14.5	14.5	20.0	65	61	68	58
12 X 6	.43	.37	7.0	12.5	12.5	18.0	60	58	60	58
12 X 8	.43	.39	5.0	10.5	10.5	16.0	60	61	62	58
12 X 10	.43	.41	4.0	9.5	9.5	15.0	64	61	64	59
14 X 6	.51	.44	9.0	17.0	14.5	22.3	108	107	112	...
14 X 8	.51	.45	7.0	15.0	12.5	20.3	104	99	108	...
14 X 10	.51	.46	5.0	13.0	10.5	18.3	100	96	100	...
14 X 12	.51	.47	4.0	12.0	9.5	17.3	100	94	100	92
16 X 6	.52	.45	11.0	19.0	16.5	24.3	132	126	144	124
16 X 8	.52	.46	9.0	17.0	14.5	22.3	128	124	136	132
16 X 10	.52	.47	7.0	15.0	12.5	20.5	128	124	128	123
16 X 12	.52	.48	5.0	13.0	10.5	18.3	125	122	119	113
16 X 14	.52	.51	4.0	12.0	12.0	20.0	140	133	138	133
18 X 8	.59	.45	14.0	22.0	19.5	27.5	194	180	195	...
18 X 10	.59	.47	12.0	20.0	17.5	25.5	196	180	185	...
18 X 12	.59	.49	10.0	18.0	15.5	23.5	185	170	190	...
18 X 14	.59	.56	8.0	16.0	16.0	24.0	190	181	200	...
18 X 16	.59	.57	7.0	15.0	15.0	23.0	196	180	190	...
20 X 10	.60	.47	14.0	22.0	19.0	27.5	225	210	210	...
20 X 12	.60	.49	12.0	20.0	17.5	25.5	210	200	210	...
20 X 14	.60	.56	10.0	18.0	18.0	26.0	208	198	205	...
20 X 16	.60	.57	8.0	16.0	16.0	24.0	225	215	222	...
20 X 18	.60	.59	7.0	15.0	15.0	23.0	233	220
24 X 12	.62	.49	16.0	24.0	21.5	29.5	310	300	310	...
24 X 14	.62	.56	14.0	22.0	22.0	30.0	315	325	335	...
24 X 16	.62	.57	12.0	20.0	20.0	28.0	325	319	310	...
24 X 18	.62	.59	10.0	18.0	18.0	26.0	312	310
24 X 20	.62	.60	8.0	16.0	16.0	24.0	315	305

**MECHANICAL JOINT SSB-DUCTILE IRON
CLASS 350 FITTINGS
ANSI/AWWA C153/A21.53
SSB/COMPACT**

SOLID & TAPPED PLUGS & CAPS**

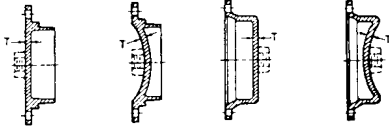

3"-12" 14"-24" 3"-12" 14"-24"
MJ Plug MJ Cap

SOLID SLEEVES

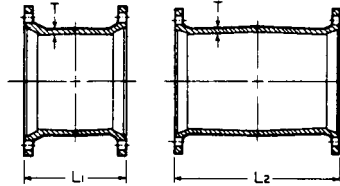

Short Long

DIMENSIONS			WEIGHTS	
SIZE	T	MAX. TAP	PLUGS	CAPS
3	.46	2.5	8	7
4	.46	3.0	10	10
6	.46	3.5	18	17
8	.46	3.5	26	25
10	.56	3.5	36	35
12	.56	3.5	46	44
14	.62	2.0	79	69
16	.62	2.0	100	92
18	.65	2.0	130	122
20	.66	2.0	153	148
24	.68	2.0	202	202

DIMENSIONS				WEIGHTS	
SIZE	T	L1	L2	SHORT	LONG
3	.34	7.5	12	13	19
4	.35	7.5	12	17	25
6	.37	7.5	12	28	36
8	.39	7.5	12	38	52
10	.41	7.5	12	49	64
12	.43	7.5	12	56	82
14	.56	9.5	15	111	141
16	.57	9.5	15	137	170
18	.68	9.0	15	160	200
20	.69	9.0	15	212	269
24	.75	9.0	15	272	368

TAPPED TEE**

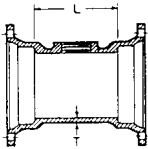

MJ Tapped Tee*

ADAPTERS**

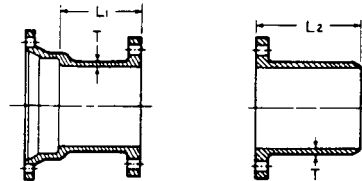

MJ x FE

FE x PE

DIMENSIONS				
SIZE	T	L	MAX. TAP	WEIGHTS
3	.34	6	2.5	19
4	.35	6	2.5	23
6	.37	6	2.5	37
8	.39	6	2.5	53
10	.41	6	2.5	68
12	.43	6	2.5	88
16	.52	6	2.0	164

DIMENSIONS				WEIGHTS	
SIZE	T	L1	L1	MJ x FE	FE x PE
3	.34	6	12	17	...
4	.35	6	12	24	24
6	.37	6	12	32	33
8	.39	6	12	50	52
10	.41	6	12	60	...
12	.43	6	12	80	...
14	.51	6	12	126	...
16	.52	6	12	159	...
20	.60	6	...	275	...

*Tapped Crosses (boss on both sides) available in some sizes.

**Not included in ANSI/AWWA C153/A21.53.

**MECHANICAL JOINT DUCTILE IRON
CLASS 350 FITTINGS
SSB/COMPACT
90° SWIVEL X SWIVEL HYDRANT ELL
(Manufacturer's Standard)**

MINIMUM DIMENSIONS									
SIZE	T	A	B	C	D	E	F	R	*WEIGHT
6	.37	10.5	15.5	7.10	11.2	6.90	8.02	6.0	51

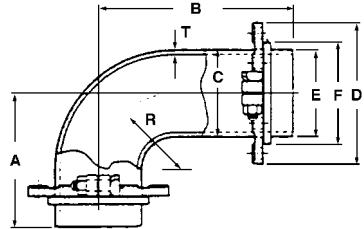

*Weight includes two swivel glands.

**DUAL PURPOSE CUTTING-IN SLEEVE
(Manufacturer's Standard)**

MI X FE CUTTING-IN SLEEVE WITH DUAL PURPOSE ACCESSORIES

DIMENSIONS					SHIPPING Wt. ASSEMBLED
SIZE	FOR PIPE SIZE	L	L1	T	
4	4.80-5.00 O.D.	10	9.5	.35	33
6	6.90-7.10 O.D.	10	9.5	.37	50
8	9.05-9.30 O.D.	10	9.5	.39	67
10	11.10-11.40 O.D.	10	9.5	.41	122
12	13.20-13.50 O.D.	10	9.5	.43	157

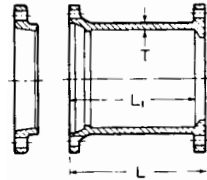

Flanged ends are faced and drilled per ANSI/AWWA C110/A21.10. Mechanical joint ends are designed to receive both standard and oversize gray or ductile iron pipe as shown above.

TYPICAL INSTALLATIONS

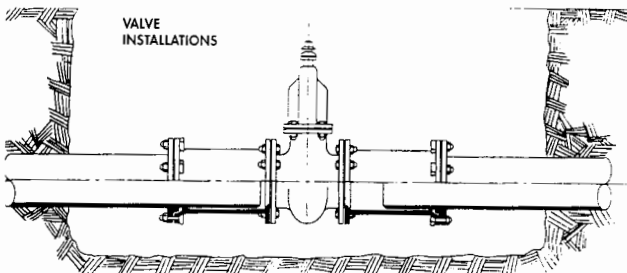
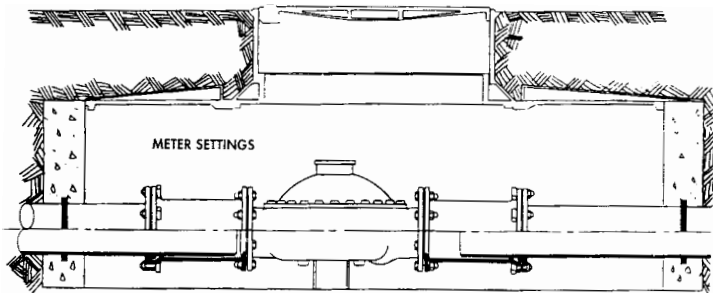

**MECHANICAL JOINT DUCTILE IRON
CLASS 350 FITTINGS
SSB/COMPACT
ANSI/AWWA C153/A21.53
PLAIN END DIMENSIONS**

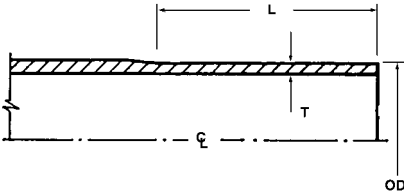

SIZE	DIMENSIONS IN INCHES			
	OD		T	L
	MINIMUM	MAXIMUM	MINIMUM	
3	3.90	4.02	.25	5.5
4	4.74	4.86	.26	5.5
6	6.84	6.96	.27	5.5
8	8.99	9.11	.29	5.5
10	11.04	11.16	.31	5.5
12	13.14	13.26	.33	5.5
14	15.22	15.35	.37	8.0
16	17.32	17.45	.40	8.0
18	19.42	19.55	.43	8.0
20	21.52	21.65	.46	8.0
24	25.72	25.85	.50	8.0

Dimension L is the minimum length of the plain end which is gauged to ensure that the outside diameter is within the OD and T dimensions.

**MECHANICAL JOINT DUCTILE IRON
CLASS 350 FITTINGS
SSB/COMPACT
FLANGE OUTLET DIMENSIONS
Manufacturer's Standard**

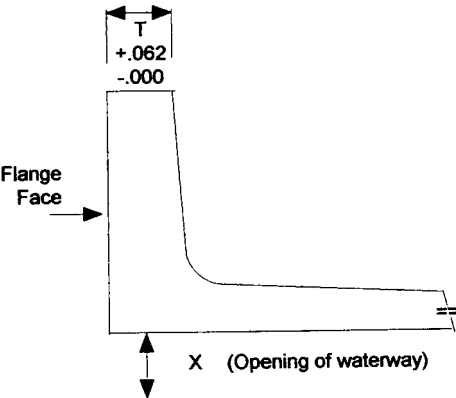

SIZE	DIMENSIONS IN INCHES	
	T	X
3	.60	3.26
4	.63	4.10
6	.63	6.16
8	.70	8.27
10	.75	10.28
12	.81	12.34
14	.87	14.13
16	.90	16.20

Flanges are faced and drilled to class 125 B16.1 Standards.

Pressure rating on fittings with Flange outlet(s) is 250 PSI unless otherwise noted on preceding pages.

**DUCTILE IRON
CLASS 350 FITTINGS**

SPECIALTY PLUGS

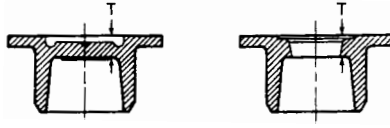

PUSH-IN PLUG

SIZE	SOLID		TAPPED	
	DIMENSIONS T		MAX. TAP	WEIGHT
4	.46		2.0	12
6	.46		2.0	20
8	.46		2.0	30
10	.56		2.0	40
12	.56		2.0	50
14	.82		2.0	110
16	.89		2.0	145
18	.96		2.0	180
20	.80		2.0	220
24	.89		2.0	315
30	...		4.0	545

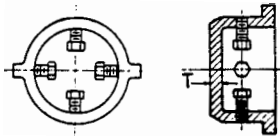

RESTRAINED PLUG

SIZE	SOLID		TAPPED	
	DIMENSIONS T		MAX. TAP	WEIGHT
4	.60		1.5	18
6	.65		3.0	25
8	.70		3.0	46
10	.75		3.0	70
12	.75		3.0	95

**DUCTILE IRON C110 FULL BODY
MECHANICAL JOINT DIMENSIONS
ANSI/AWWA C110/A21.10, ANSI/AWWA C111/A21.11**

SAMPLE SPECIFICATION

2" THRU 36" MECHANICAL JOINT FITTINGS shall be ductile iron and shall be produced in accordance with ANSI/AWWA C110/A21.10 and ANSI/AWWA C111/A21.11 and shall conform to details and dimensions published therein.

NOTE: Fittings are CEMENT-LINED and seal coated in accordance with ANSI/AWWA C104/A21.4; also available double cement-lined or bare. See list price sheet for details.

JOINT DIMENSIONS IN INCHES FOR MECHANICAL JOINT FITTINGS

DIMENSIONS IN INCHES

SIZE	A	B	C	D	F	Ø	X	J	K1	K2	L	M	N	O	P	S	Y
*2	2.50	2.50	3.39	3.50	2.61	28°	3/4	4.75	6.25	6.25	.75	.62	.50	.31	.63	.44	.08
3	3.96	2.50	4.84	4.94	4.06	28°	3/4	6.19	7.69	7.69	.94	.62	.75	.31	.63	.52	.12
4	4.80	2.50	5.92	6.02	4.90	28°	7/8	7.50	9.12	9.12	1.00	.75	.75	.31	.75	.65	.12
6	6.90	2.50	8.02	8.12	7.00	28°	7/8	9.50	11.12	11.12	1.06	.88	.75	.31	.75	.70	.12
8	9.05	2.50	10.17	10.27	9.15	28°	7/8	11.75	13.37	13.37	1.12	1.00	.75	.31	.75	.75	.12
10	11.10	2.50	12.22	12.34	11.20	28°	7/8	14.00	15.69	15.62	1.19	1.00	.75	.31	.75	.80	.12
12	13.20	2.50	14.32	14.44	13.30	28°	7/8	16.25	17.94	17.88	1.25	1.00	.75	.31	.75	.85	.12
14	15.30	3.50	16.40	16.54	15.44	28°	7/8	18.75	20.31	20.25	1.31	1.25	.75	.31	.75	.89	.12
16	17.40	3.50	18.50	18.64	17.54	28°	7/8	21.00	22.56	22.50	1.38	1.31	.75	.31	.75	.97	.12
18	19.50	3.50	20.60	20.74	19.64	28°	7/8	23.25	24.83	24.75	1.44	1.38	.75	.31	.75	1.05	.12
20	21.60	3.50	22.70	22.84	21.74	28°	7/8	25.50	27.08	27.00	1.50	1.44	.75	.31	.75	1.12	.12
24	25.80	3.50	26.90	27.04	25.94	28°	7/8	30.00	31.58	31.50	1.62	1.56	.75	.31	.75	1.22	.12
30	32.00	4.00	33.29	33.46	32.17	20°	1-1/8	36.88	39.12	39.12	1.81	2.00	.75	.38	1.00	1.50	.12
36	38.30	4.00	39.59	39.76	38.47	20°	1-1/8	43.75	46.00	46.00	2.00	2.00	.75	.38	1.00	1.80	.12

*Not included in AWWA C110.

SIZE	No.	BOLT SIZE	MIN. BOLT LENGTH	BOLT TORQUE Ft/Lbs.	PIPE BARREL O. D.
*2	2	5/8	2-1/2	45-60	2.50
3	4	5/8	3	45-60	3.96
4	4	3/4	3-1/2	75-90	4.80
6	6	3/4	3-1/2	75-90	6.90
8	6	3/4	4	75-90	9.05
10	8	3/4	4	75-90	11.10
12	8	3/4	4	75-90	13.20
14	10	3/4	4-1/2	75-90	15.30
16	12	3/4	4-1/2	75-90	17.40
18	12	3/4	4-1/2	75-90	19.50
20	14	3/4	4-1/2	75-90	21.60
24	16	3/4	5	75-90	25.80
30	20	1	6	100-120	32.00
36	24	1	6	100-120	38.30

*Not included in AWWA C110.

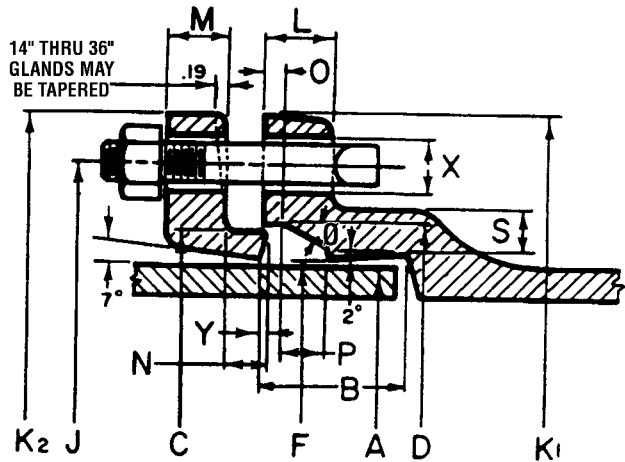

**DUCTILE IRON C110- FULL BODY
MECHANICAL JOINT FITTINGS
ANSI/AWWA C110/A21.10**

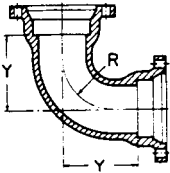

90° MJ x MJ (1/4)

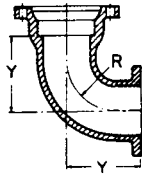

90° MJ x FE (1/4)

90° BENDS (1/4)

SIZE	DIMENSIONS		WEIGHTS	
	R	Y	MJ x MJ	MJ x FE*
*2	2.25	3.25	14	...
3	4.0	5.5	35	32
4	4.5	6.5	55	39
6	6.0	8.0	85	75
8	7.0	9.0	125	115
10	9.0	11.0	190	165
12	10.0	12.0	255	246
14	11.5	14.0	380	310
16	12.5	15.0	490	415
18	14.0	16.5	625	520
20	15.5	18.0	790	660
24	18.5	22.0	1215	1150
30	21.5	25.0	2030	...
36	24.5	28.0	2475	...

*Not included in AWWA C110.

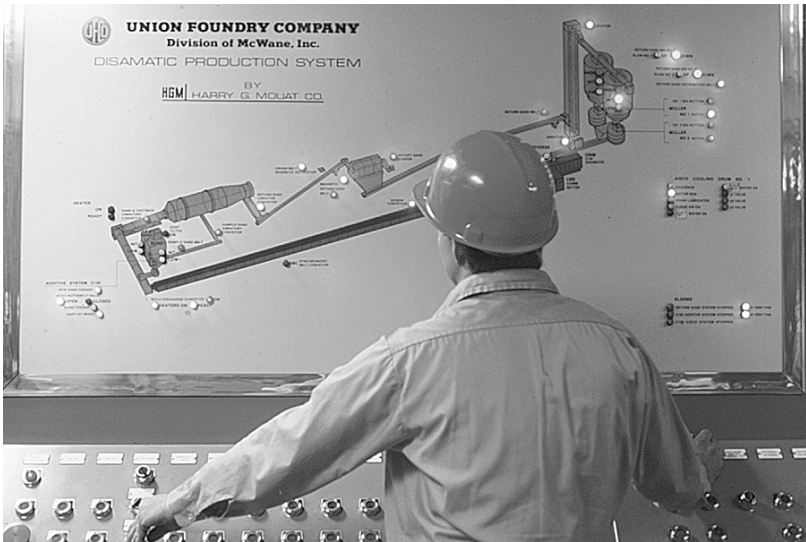

**DUCTILE IRON C110 FULL BODY
MECHANICAL JOINT FITTINGS
ANSI/AWWA C110/A21.10**

BENDS

45° BENDS (1/8)

DIMENSIONS				WEIGHTS		
SIZE	R	Y	Z	MJ	MJ x FE*	MJ x PE
*2	1.96	1.8	...	13
3	3.62	3.0	11.0	30	30	30
4	4.81	4.0	12.0	50	42	45
6	7.25	5.0	13.0	75	60	70
8	8.44	5.5	13.5	110	105	105
10	10.88	6.5	14.5	155	135	155
12	13.25	7.5	15.5	215	200	215
14	12.06	7.5	15.5	300	255	280
16	13.25	8.0	16.0	380	360	360
18	14.50	8.5	16.5	470	422	445
20	16.88	9.5	17.5	595	500	565
24	18.12	11.0	19.0	865	800	825
30	27.75	15.0	23.0	1620	...	1275
36	35.00	18.0	26.0	2095	...	1930

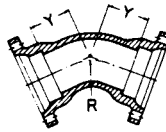

45° MJ (1/8)

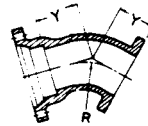

45° MJ x FE (1/8)

22-1/2° BENDS (1/16)

DIMENSIONS				WEIGHTS		
SIZE	R	Y	Z	MJ	MJ x FE*	MJ x PE
3	7.56	3.0	11.0	30	30	30
4	10.06	4.0	12.0	50	45	45
6	15.06	5.0	13.0	75	60	70
8	17.62	5.5	13.5	110	105	105
10	22.62	6.5	14.5	160	150	160
12	27.62	7.5	15.5	220	200	220
14	25.12	7.5	15.5	300	260	285
16	27.62	8.0	16.0	385	315	365
18	30.19	8.5	16.5	480	422	455
20	35.19	9.5	17.5	605	...	575
24	37.69	11.0	19.0	880	800	725
30	57.81	15.0	23.0	1650	...	1295
36	72.88	18.0	26.0	2135	...	1970

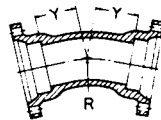

22 1/2° MJ (1/16)

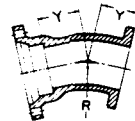

22 1/2° MJ x FE (1/16)

11-1/4° BENDS (1/32)

DIMENSIONS				WEIGHTS		
SIZE	R	Y	Z	MJ	MJ x FE*	MJ x PE
3	15.25	3.0	11.0	30	30	...
4	20.31	4.0	12.0	50	45	45
6	30.50	5.0	13.0	75	69	70
8	35.50	5.5	13.5	110	105	105
10	45.69	6.5	14.5	160	155	160
12	55.81	7.5	15.5	220	215	220
14	50.75	7.5	15.5	305	275	285
16	55.81	8.0	16.0	385	300	365
18	60.94	8.5	16.5	480	390	455
20	71.06	9.5	17.5	610	500	575
24	76.12	11.0	19.0	885	800	845
30	116.75	15.0	23.0	1410	...	1305
36	147.25	18.0	26.0	2145	...	1980

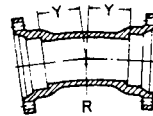

11 1/4° MJ (1/32)

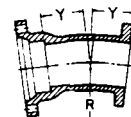

11 1/4° MJ x FE (1/32)

*Not included in AWWA C110.

**DUCTILE IRON C110 FULL BODY
MECHANICAL JOINT FITTINGS
ANSI/AWWA C110/A21.10**

TEES

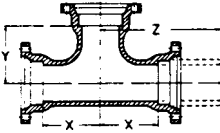

**Straight Tees and
Reducing on Branch Tees**

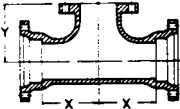

TL x TL x FE

SIZE RUN	BRANCH	DIMENSIONS		WEIGHTS	
		X	Y	*TL x TL x FE	**TL x TL x FE
2	2	3.25	3.25
3	2	3.25	3.25
3	3	5.5	5.5
4	2	4.8	4.8	...	53
4	3	6.5	6.5
4	4	6.5	6.5	75	74
4	6	8.0	8.0
6	2	8.0	8.0
6	3	8.0	8.0
6	4	8.0	8.0	...	109
6	6	8.0	8.0	120	114
6	8	9.0	9.0
8	3	9.0	9.0
8	4	9.0	9.0	...	159
8	6	9.0	9.0	170	165
8	8	9.0	9.0	180	175
10	4	11.0	11.0	...	229
10	6	11.0	11.0	...	237
10	8	11.0	11.0	...	250
10	10	11.0	11.0	250	...

*Not included in AWWA C110

**Made to order only. Not Returnable.

**DUCTILE IRON C110 FULL BODY
MECHANICAL JOINT FITTINGS
ANSI/AWWA C110/A21.10, ANSI/AWWA C111/A21.11
TEES (Con't)**

RUN	SIZE RUN	DIMENSIONS				WEIGHTS		
		BRANCH	X	Y	Z	MJ	**MJ x PE x MJ	**MJ x MJ x FE
12	12	4	12.0	12.0	20.0	315	315	309
12	12	6	12.0	12.0	20.0	325	325	315
12	12	8	12.0	12.0	20.0	340	240	330
12	12	10	12.0	12.0	20.0	390	390	...
12	12	12	12.0	12.0	20.0	410	410	400
14	14	8	14.0	14.0	...	500
14	14	14	14.0	14.0	...	585
*16	16	4	15.0	15.0	...	600	...	575
16	16	6	15.0	15.0	...	615	...	605
16	16	8	15.0	15.0	...	625	...	615
16	16	10	15.0	15.0	...	645
16	16	12	15.0	15.0	...	660	...	650
16	16	16	15.0	15.0	...	740	...	730
18	18	6	13.0	15.5	...	670	...	665
18	10	13.0	15.5	760	...			
18	18	8	13.0	15.5	...	685	...	675
18	18	12	13.0	15.5	...	715	...	705
18	18	18	16.5	16.5	...	945	...	915
20	20	6	14.0	17.0	...	830	...	820
20	20	8	14.0	17.0	...	845	...	835
20	20	12	14.0	17.0	...	875	...	865
20	20	16	18.0	18.0	...	1095	...	1075
20	20	20	18.0	18.0	...	1185	...	1165
24	24	6	15.0	19.0	...	1145	...	1125
24	24	8	15.0	19.0	...	1160	...	1140
24	24	10	15.0	19.0	...	1170
24	24	12	15.0	19.0	...	1185	...	1165
24	24	14	15.0	19.0	...	1220
24	24	16	15.0	19.0	...	1245
24	24	18	22.0	22.0	...	1660
24	24	20	22.0	22.0	...	1720
24	24	24	22.0	22.0	...	1815	...	1795
30	30	6	18.0	23.0	...	1730
30	30	8	18.0	23.0	...	1745
30	30	10	18.0	23.0	...	1760
30	30	12	18.0	23.0	...	1780	...	2065
30	30	16	18.0	23.0	...	1954
30	30	18	18.0	23.0	...	1845
30	30	20	18.0	23.0	...	1875
30	30	24	25.0	25.0	...	2400
30	30	30	25.0	25.0	...	2595	...	3080
*36	36	6	20.0	26.0	...	2439	...	2430
36	36	8	20.0	26.0	...	2520
36	36	10	20.0	26.0	...	2535
36	36	12	20.0	26.0	...	2550
36	36	14	20.0	26.0	...	2570
36	36	16	20.0	26.0	...	2585
36	36	18	20.0	26.0	...	2610
36	36	20	20.0	26.0	...	2635
36	36	24	20.0	26.0	...	2792	...	2660
36	36	30	28.0	28.0	...	3545
36	36	36	28.0	28.0	...	3982

* Not included in AWWA C110.

** Made to order only. Not Returnable.

**DUCTILE IRON C110 FULL BODY
MECHANICAL JOINT FITTINGS
ANSI/AWWA C110/A21.10, ANSI/AWWA C111/A21.11**

WYES

(Not included in AWWA C110.)

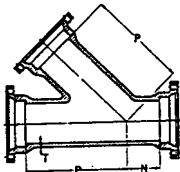

TL x TL x TL

SIZE		DIMENSIONS		WEIGHTS
RUN	BRANCH	P	N	
3	3	10.0	3.0	60
4	4	12.0	3.0	90
6	3	14.5	3.5	120
6	4	14.5	3.5	130
6	6	14.5	3.5	145
8	4	17.5	4.5	190
8	6	17.5	4.5	208
8	8	17.5	4.5	230
10	6	20.5	5.0	335
10	8	20.5	5.0	310
10	10	20.5	5.0	435
12	8	24.5	5.5	505
12	12	24.5	5.5	490
14	6	27.0	6.0	626
16	16	30.0	6.5	1079
18	8	32.0	7.0	940
18	10	32.0	7.0	975
18	12	32.0	7.0	1015
18	16	32.0	7.0	1135
18	18	32.0	7.0	1200
20	10	35.0	8.0	1220
20	12	35.0	8.0	1260
20	16	35.0	8.0	1375
20	20	35.0	8.0	1525
24	24	40.5	9.0	2372

SIZE		DIMENSIONS			WEIGHTS
RUN	BRANCH	P	N	S	
6	6	14.5	3.5	11.5	140
8	8	17.5	4.5	12.5	185
10	6	20.5	5.0	13.0	285
12	12	24.5	5.5	13.5	410

ADAPTERS (Not included in AWWA C110.)

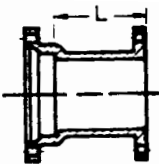

TL x FE

SIZE	LENGTH L	WEIGHTS
3	8"	30
4	8"	40
6	8"	60
8	8"	85
10	8"	115
12	8"	155
14	8"	195
16	8"	240
18	8"	305
20	8"	340
24	8"	495
30	10"	840

**DUCTILE IRON C110 FULL BODY
MECHANICAL JOINT FITTINGS
ANSI/AWWA C110/A21.10, ANSI/AWWA C111/A21.11**

CROSSES

SIZE		DIMENSIONS		WEIGHTS	
RUN	BRANCH	X	Y	MJ	*MJ x FE
6	6	8.0	8.0	160	120
8	6	9.0	9.0	205	180
8	8	9.0	9.0	235	215
10	10	11.0	11.0	380	330
12	6	12.0	12.0	360	340
12	8	12.0	12.0	385	365
12	10	12.0	12.0	460	434
12	12	12.0	12.0	495	487
16	8	15.0	15.0	675	655
16	12	15.0	15.0	685	635
16	16	15.0	15.0	895	875
18	8	13.0	15.5	730	...
18	10	13.0	15.5	760	...
18	12	13.0	15.5	790	...
18	18	16.5	16.5	1130	...
20	6	14.0	17.0	865	...
20	8	14.0	17.0	890	...
20	12	14.0	17.0	955	...
20	16	18.0	18.0	1245	...
20	20	18.0	18.0	1415	...
24	6	15.0	19.0	1180	...
24	8	15.0	19.0	1200	...
24	12	15.0	19.0	1260	...
24	16	15.0	19.0	1375	...
24	18	22.0	22.0	1865	...
24	24	22.0	22.0	2155	...
30	6	18.0	23.0	2085	...
30	12	18.0	23.0	2165	...
30	24	25.0	25.0	3180	...
30	30	25.0	25.0	3640	...
36	36	28.0	28.0	4370	...

*Not included in AWWA C110.

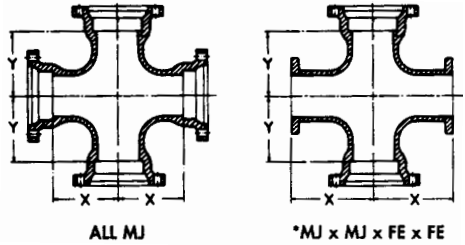

MJ TAPPED TEE

SIZE	DIMENSIONS		WEIGHTS
	L	MAX. TAP (IN.)	
3	8	2	35
4	8	2	45
6	8	2	70
8	8	2	95
10	8	2	130
12	8	2	165

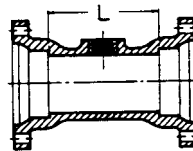

TL Tapped Tee

**DUCTILE IRON C110 FULL BODY
MECHANICAL JOINT FITTINGS
ANSI/AWWA C110/A21.10, ANSI/AWWA C111/A21.11
REDUCERS**

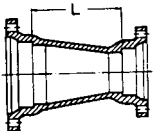

MJ Reducer

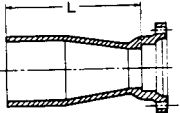

MJ Small End Bell Reducer

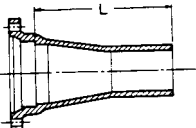

MJ Large End Bell Reducer

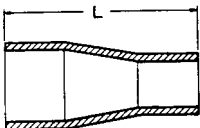

Plain End-Plain End Reducer

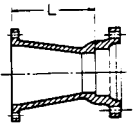

FE x MJ Reducer

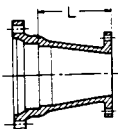

MJ x FE Reducer

SIZE	LAYING LENGTHS						WEIGHTS					
	MJ	MJ- SEB	MJ- LEB	PE x PE	*FE x MJ	*MJ x FE	MJ	MJ- SEB	MJ- LEB	PE x PE	*FE x MJ	*MJ x FE
*3 X 2	6	14	14	25	25	20
*4 X 2	7	15	15	30	30	30
4 X 3	7	15	15	23	7	7	40	34	40	35	34	33
*6 X 2	9	17	17	45	45	45
6 X 3	9	17	17	25	...	9	55	50	50	50	...	46
6 X 4	9	17	17	25	9	9	60	60	60	55	52	54
8 X 3	11	19	19	27	75	70	70	70
8 X 4	11	19	19	27	11	11	80	80	80	75	75	72
8 X 6	11	19	19	27	11	11	95	90	90	85	80	77
10 X 6	12	20	20	...	12	12	115	115	115	...	114	105
10 X 8	12	20	20	...	12	12	135	130	130	...	145	115
12 X 4	14	22	22	135	130
12 X 6	14	22	22	30	14	12	150	150	145	145	125	145
12 X 8	14	22	22	30	14	12	165	165	165	165	165	165
12 X 10	14	22	22	30	14	12	190	190	185	185	190	185
14 X 6	16	24	24	32	200	185	200	185
14 X 8	16	24	24	32	220	205	220	205
14 X 10	16	24	24	245	230	245
14 X 12	16	24	24	32	270	255	275	260
16 X 6	18	26	26	250
16 X 8	18	26	26	34	270	350	...	250
16 X 10	18	26	26	300
16 X 12	18	26	26	...	18	18	325	305	330	...	305	315
16 X 14	18	26	26	370
18 X 8	19	27	27	19	320	290
18 X 10	19	27	27	350
18 X 12	19	27	27	19	380	355	360
18 X 14	19	27	27	425
18 X 16	19	27	27	19	465	385
20 X 10	20	28	28	410
20 X 12	20	28	28	440	410
20 X 16	20	28	28	20	530	500	510	510
20 X 18	20	28	28	575
24 X 12	24	32	32	24	610	570	615	455
24 X 16	24	32	32	705	665	685
24 X 18	24	32	32	760	570	615
24 X 20	24	32	32	815	775	785
*30 X 16	30	38	38	46	1150	1040	...	1015
30 X 18	30	38	38	46	1160	1050	...	1025
30 X 20	30	38	38	46	1225	1120	1020	1090
30 X 24	30	38	38	46	1360	1255	1125	1215
36 X 20	36	...	44	1495	1285	1466	1298
36 X 24	36	...	44	52	1580	1436	1535	1389
36 X 30	36	44	44	52	1919	1721	1750	1585

*Not included in AWWA C110.

**DUCTILE IRON C110 FULL BODY
MECHANICAL JOINT FITTINGS
ANSI/AWWA C110/A21.10, ANSI/AWWA C111/A21.11
SOLID SLEEVES**

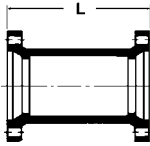

STANDARD

SIZE	PIPE O.D.	SHORT		LONG	
		L	WEIGHT	L	WEIGHT
*2	2.50	8.0	12	12	18
3	3.96	7.5	25	12	30
4	4.80	7.5	35	12	45
6	6.90	7.5	45	12	65
8	9.05	7.5	65	12	85
10	11.10	7.5	85	12	115
12	13.20	7.5	100	12	145
14	15.30	9.5	165	15	225
16	17.40	9.5	200	15	275
18	19.50	9.5	240	15	330
20	21.60	9.5	275	15	380
24	25.80	9.5	360	15	505
30	32.00	15.0	745	24	1085
36	38.30	15.0	1047	24	1502

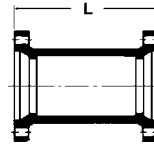

***DUAL PURPOSE †**

SIZE	PIPE O.D.	SHORT		LONG	
		L	WEIGHT	L	WEIGHT
4	4.80/5.00	7.5	35	12	45
6	6.90/7.10	7.5	45	12	65
8	9.05/9.30	7.5	65	12	85
10	11.10/11.40	12	115
12	13.20/13.50	12	235
16	17.40/17.80	15	385

†Uses Dual Purpose Gland (included)

*Not included in AWWA C110.

***MJ x PE DUAL-PURPOSE CUTTING-IN SLEEVE**

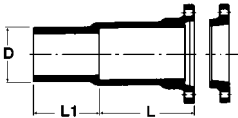

With Dual-Purpose Accessories

NOTE: Gland with cup-point set screws available at extra cost when specified. **NOT FOR RESTRAINT.**

SLEEVE & GLAND

SIZE	FOR USE ON PIPE O.D.	L	L1	D	WEIGHT	
					GLAND ONLY	GLAND & SLEEVE
4	4.80-5.00	12	8	4.80	9.5	72
6	6.90-7.10	12	8	6.90	13.0	98
8	9.05-9.30	12	8	9.05	20.0	136
10	11.10-11.40	12	8	11.10	25.0	175
12	13.20-13.50	12	8	13.20	30.0	235

*Not included in AWWA C110.

SPLIT REPAIR SLEEVE WITH ACCESSORIES

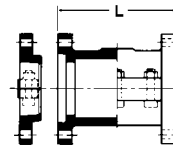

GLAND AND SPLIT SLEEVE

SIZE	L	*WEIGHT	GLAND WEIGHT ONLY
4	15	115	9
6	18	165	16
8	18	215	24

*Weights include all accessories assembled.

**DUCTILE IRON C110 FULL BODY
MECHANICAL JOINT SWIVEL FITTINGS,
ELLS, ADAPTERS AND GLANDS**
*For Valve and Hydrant Connections***

TEES

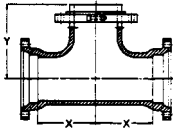

MJ x MJ x Swivel

PARALLEL TEES

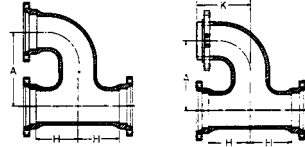

MJ x MJ x MJ

MJ x MJ x Swivel

SIZE	DIMENSIONS			WEIGHT*
	X	Y	Y1	MJ x MJ x S
6	8.0	10.5	15.5	116
8 X 6	9.0	11.5	16.5	165
8	9.0	11.5	16.5	198
10 X 6	11.0	13.5	...	270
12 X 6	12.0	14.5	...	345
14 X 6	14.0	16.5	...	500
16 X 6	15.0	17.5	...	619
16 X 8	15.0	17.5	...	649
18 X 6	13.0	17.5	...	750
20 X 6	14.0	19.5	...	829
24 X 6	15.0	21.5	...	1134
30 X 6	18.0	24.5	...	1739

SIZE	DIMENSIONS			WEIGHTS	
	A	H	K	MJ	MJ x MJ x S
6	12.5	8	10.5	150	185
8 X 6	13.5	9	11.5	230	250
10 X 6	15.0	11	13.5	...	320
12 X 6	15.0	12	14.5	...	345

ADAPTERS

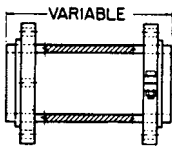

Swivel x Solid Adapter

ELLS

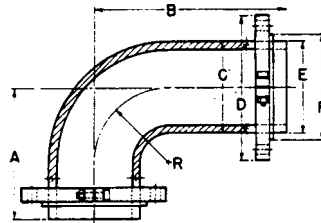

90° Swivel x Swivel Ell

SIZE BY LAYING LENGTH	WEIGHT*
4 X 13	61
6 X 12	42
6 X 18	58
6 X 24	69
6 X 36	129
8 X 12	70
12 X 13	173

SIZE	DIMENSIONS							*WEIGHT
	A	B	C	D	E	F	R	
6	10.5	15.5	7.10	11.12	6.90	8.02	6.0	100
8	11.5	16.5	9.20	13.37	9.05	10.17	7.0	140

*Weights with Glands.

** (Not included in AWWA C110)

**DUCTILE IRON C110 FULL BODY
MECHANICAL JOINT FITTINGS
ANSI/AWWA C110/A21.10, ANSI/AWWA C111/A21.11**

PLUGS †

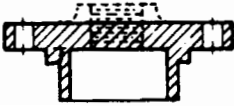

CAPS †

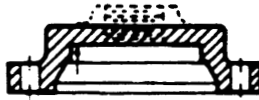

OFFSETS

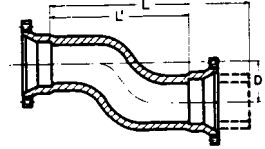

SOLID OR TAPPED

SIZE	MAX. TAP	WEIGHT	
		SOLID	TAPPED
*2	2	5	5
3	3	10	10
4	3	15	15
6	3	25	25
8	4	45	45
10	4	65	65
12	4	85	85
14	4	120	120
16	4	150	150
18	4	180	180
20	4	200	200
24	4	290	290
30	4	575	575
36	4	815	815

SOLID OR TAPPED

SIZE	TAP	WEIGHT	
		SOLID	TAPPED
*2	2	5	...
3	3	12	12
4	3	20	20
6	3	30	30
8	4	45	45
10	4	60	60
12	4	80	80
14	4	110	110
16	4	150	150
18	4	185	185
20	4	250	250
24	4	300	300
30	4	590	590
36	4	850	850

MJ x MJ

MJ x PE

SIZE	D	DIMENSIONS		WEIGHTS	
		L1	L	MJ x MJ	MJ x PE
4	6	19	27	75	70
4	12	22	30	85	80
4	18	30	38	105	100
*4	24	26	34	120	115
6	6	20	28	110	105
6	12	26	34	135	130
6	18	33	41	165	160
*6	24	24	32	165	160
8	6	21	29	160	155
8	12	28	36	200	195
8	18	35	43	245	240
*8	24	36	44	280	275
10	12	30	38	280	280
10	18	38	46	340	340
10	24	38	46	420	...
12	6	26	34	320	320
12	12	37	45	420	420
12	18	48	56	520	520
*12	24	48	56	640	630
16	12	40	48	715	690
16	18	50	58	850	830
*20	12	40	48	1025	...
*20	18	48	60	1275	...

†Certain sizes have convex or concave surfaces.

*Not included in AWWA C110.

†Certain sizes have convex or concave surfaces.

*Not included in AWWA C110.

MJ GLAND



*Not included in AWWA C110.

SIZE	WEIGHT
*2	4
3	5
4	6
6	11
8	18
10	20
12	30
14	35
16	45
18	55
20	70
24	90
30	180
36	248

*Not included in AWWA C110.

**DUCTILE IRON C110 FULL BODY
MECHANICAL JOINT FITTINGS**
Mechanical Joint Plain-end Dimensions
ANSI/AWWA C110/A21.10, ANSI/AWWA C111/A21.11

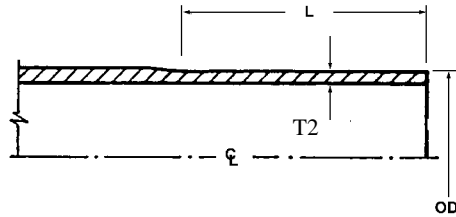

All sizes of fittings with plain ends have 8 inches of added laying length as compared with the laying length of standard all-MJ fittings.

Dimension L is the minimum length of the plain end which is gauged to ensure that the outside diameter is within the OD and T2 dimensions.

SIZE	DIMENSIONS IN INCHES			
	OD		T2	L
	MINIMUM	MAXIMUM	MINIMUM	
3	3.90	4.02	.38	5.5
4	4.74	4.86	.37	5.5
6	6.84	6.96	.40	5.5
8	8.99	9.11	.42	5.5
10	11.04	11.16	.48	5.5
12	13.14	13.26	.56	5.5
14	15.22	15.35	.54	8.0
16	17.32	17.45	.58	8.0
18	19.42	19.55	.63	8.0
20	21.52	21.65	.68	8.0
24	25.72	25.85	.74	8.0
30	31.94	32.08	.88	8.0
36	38.24	38.38	1.00	8.0

**DUCTILE IRON C110
FLANGED FITTINGS**

ANSI/AWWA C110/A21.10, ANSI/AWWA C111/A21.11

SAMPLE SPECIFICATION: DUCTILE IRON FITTINGS shall be produced in accordance with all applicable terms of ANSI/AWWA C110. They shall conform to details and dimensions published therein and shall be adequate for water pressure of 250 lbs. P.S.I.

JOINT DIMENSIONS IN INCHES

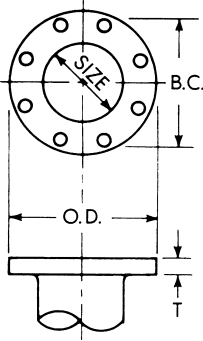

NOMINAL PIPE SIZE INCH	FLANGE O.D.	DIA. OF BOLT CIRCLE	FLANGE THICKNESS T	BOLT HOLE DIAMETER	NUMBER OF BOLTS	BOLT DIA. AND LENGTHS
2	6	4.75	.62	.75	4	5/8 X 2-1/4
3	7.5	6	.75	.75	4	5/8 X 2-1/2
4	9	7.5	.94	.75	8	5/8 X 3
6	11	9.5	1.00	.875	8	3/4 X 3-1/2
8	13.5	11.75	1.12	.875	8	3/4 X 3-1/2
10	16	14.25	1.19	1.00	12	7/8 X 4
12	19	17	1.25	1.00	12	7/8 X 4
14	21	18.75	1.38	1.125	12	1 X 4-1/2
16	23.5	21.25	1.44	1.125	16	1 X 4-1/2
18	25	22.75	1.56	1.25	16	1-1/8 X 5
20	27.5	25	1.69	1.25	20	1-1/8 X 5
24	32	29.5	1.88	1.375	20	1-1/4 X 5-1/2
30	38.75	36	2.12	1.375	28	1-1/4 X 6-1/2

NOTE: No flange joint material furnished.

NOTE: Drilling templates are in multiples of four, so that fittings may be made to face in any quarter. Bolt holes shall straddle the center line.

BENDS

Note: Base Bends are on page 66.

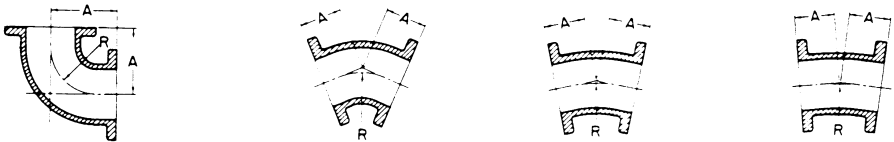

90° Bends (1/4)

45° Bends (1/8)

22-1/2° Bends (1/16)

11-1/4° Bends (1/32)

SIZE	DIMENSIONS			DIMENSIONS			DIMENSIONS			DIMENSIONS		
	R	A	MINIMUM WEIGHT	R	A	MINIMUM WEIGHT	R	A	MINIMUM WEIGHT	R	A	MINIMUM WEIGHT
2	3	4.5	14
3	4	5.5	25	3.62	3	20	7.56	3	20	15.25	3	20
4	4.5	6.5	45	4.81	4	40	10.06	4	40	20.31	4	40
6	6	8	65	7.25	5	55	15.06	5	55	30.5	5	55
8	7	9	105	8.44	5.5	90	17.62	5.5	90	35.5	5.5	90
10	9	11	165	10.88	6.5	130	22.62	6.5	130	45.69	6.5	130
12	10	12	235	13.25	7.5	195	27.67	7.5	195	55.81	7.5	195
14	11.5	14	330	12.06	7.5	245	25.12	7.5	250	50.75	7.5	245
16	12.5	15	430	13.25	8	315	27.62	8	315	55.81	8	315
18	14	16.5	530	14.5	8.5	375	30.19	8.5	385	60.94	8.5	385
20	15.5	18	685	16.88	9.5	485	35.19	9.5	505	71.06	9.5	505
24	18.5	22	1085	18.12	11	730	37.69	11	755	76.12	11	760
30	21.5	25	1755	27.75	15	1335	116.75	15	1395
36	24.5	28	2135

**DUCTILE IRON C110
FLANGED FITTINGS
ANSI/AWWA C110/A21.10, ANSI/AWWA C111/A21.11**

TEES, REDUCING TEES, CROSSES

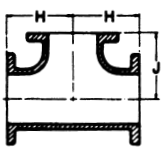

Straight Tees,
Reducing on
Branch Tees

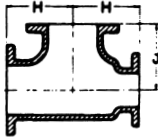

*Reducing
on Run

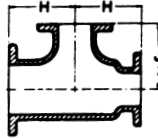

*Reducing on
Run and
Branch

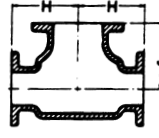

*Bullhead
Tees

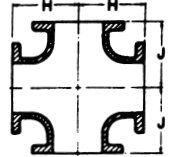

Straight and
Reducing
Crosses

RUN	SIZE	BRANCH	DIMENSIONS		WEIGHTS		RUN	SIZE	RUN	BRANCH	DIMENSIONS		WEIGHTS	
	RUN		H	J	TEE	CROSS					H	J	TEE	CROSS
3	3	2	4.5	4.5	35	...	12	8	8	14.0	14.0	375	...	
3	3	3	5.5	5.5	40	50	12	8	12	14.0	14.0	420	...	
4	3	3	6.5	5.5	55	...	†12	10	6	14.0	14.0	390	...	
*4	4	2	6.5	6.5	50	...	12	10	8	14.0	14.0	400	...	
4	4	3	6.5	6.5	60	70	12	10	10	14.0	14.0	420	...	
4	4	4	6.5	6.5	60	80	12	10	12	14.0	14.0	440	...	
4	4	6	8.0	8.0	90	...	12	12	4	12.0	12.0	290	310	
6	4	4	8.0	8.0	85	...	12	12	6	12.0	12.0	295	320	
6	4	6	8.0	8.0	90	...	12	12	8	12.0	12.0	310	345	
*6	6	2	8.0	8.0	85	...	12	12	10	12.0	12.0	360	415	
6	6	3	8.0	8.0	85	95	12	12	12	12.0	12.0	385	460	
6	6	4	8.0	8.0	90	110	*14	14	4	14.0	14.0	410	...	
6	6	6	8.0	8.0	95	120	14	14	6	14.0	14.0	420	450	
6	6	8	9.0	9.0	140	...	14	14	8	14.0	14.0	435	475	
8	6	4	9.0	9.0	130	...	14	14	10	14.0	14.0	450	...	
8	6	6	9.0	9.0	135	...	14	14	12	14.0	14.0	470	555	
8	6	8	9.0	9.0	145	...	14	14	14	14.0	14.0	500	595	
*8	8	3	9.0	9.0	130	140	*16	16	4	15.0	15.0	525	...	
8	8	4	9.0	9.0	140	155	16	16	6	15.0	15.0	540	565	
8	8	6	9.0	9.0	145	165	16	16	8	15.0	15.0	555	590	
8	8	8	9.0	9.0	155	195	16	16	10	15.0	15.0	565	620	
8	8	10	11.0	11.0	260	...	16	16	12	15.0	15.0	590	665	
8	8	12	12.0	12.0	310	...	16	16	14	15.0	15.0	610	...	
†10	6	6	13.0	13.0	275	...	16	16	16	15.0	15.0	635	755	
†10	6	10	13.0	13.0	305	...	18	18	6	13.0	15.5	560	...	
†10	8	6	13.0	13.0	280	...	18	18	8	13.0	15.5	570	...	
†10	8	8	13.0	13.0	295	...	18	18	10	13.0	15.5	585	...	
†10	8	10	13.0	13.0	325	...	18	18	12	13.0	15.5	605	670	
10	10	4	11.0	11.0	205	220	18	18	14	16.5	16.5	740	...	
10	10	6	11.0	11.0	215	240	18	18	16	16.5	16.5	760	...	
10	10	8	11.0	11.0	225	265	18	18	18	16.5	16.5	785	915	
10	10	10	11.0	11.0	270	330	20	20	6	14.0	17.0	710	...	
10	10	12	12.0	12.0	355	...	20	20	8	14.0	17.0	720	...	
†12	6	6	14.0	14.0	340	...	20	20	10	14.0	17.0	735	...	
†12	6	8	14.0	14.0	360	...	20	20	12	14.0	17.0	755	820	
†12	8	6	14.0	14.0	355	...	20	20	14	14.0	17.0	770	...	
							20	20	16	18.0	18.0	950	1065	
							20	20	20	18.0	18.0	1005	1175	

* Not included in AWWA C110

† H and J dimensions are two-inches longer than straight tees.

**DUCTILE IRON C110
FLANGED FITTINGS
ANSI/AWWA C110/A21.10, ANSI/AWWA C111/A21.11**

TEES, REDUCING TEES, CROSSES (Con't)

RUN	SIZE RUN	BRANCH	DIMENSIONS		WEIGHTS	
			H	J	TEE	CROSS
24	24	6	15.0	19.0	1000	...
24	24	8	15.0	19.0	1010	...
24	24	10	15.0	19.0	1020	...
24	24	12	15.0	19.0	1040	1100
24	24	14	15.0	19.0	1050	1125
24	24	16	15.0	19.0	1070	1160
24	24	18	22.0	22.0	1470	...
24	24	20	22.0	22.0	1510	1695
24	24	24	22.0	22.0	1585	1850
*30	30	6	18.0	23.0	1725	...
30	30	12	18.0	23.0	1780	...
30	30	18	18.0	23.0	1815	...
30	30	24	25.0	25.0	2475	2695
30	30	30	25.0	25.0	2615	2980
36	36	12	20.0	26.0	2170	—
36	36	16	20.0	26.0	2185	—
36	36	20	20.0	26.0	2210	—
36	36	24	20.0	26.0	2255	—
36	36	36	28.0	28.0	3160	—

*Not included in AWWA C110.

**DUCTILE IRON C110
FLANGED FITTINGS
(Manufacturer's Standards)**

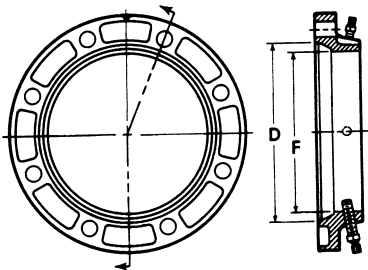

SIZE	RATED WORKING PRESSURE	NO. OF SET SCREWS	BOLT CIRCLE	NO. OF BOLT & NUTS	SIZE OF BOLT	BOLT HOLE DIM.
3	250	4	6.00	4	5/8 X 2-1/2	3/4
4	250	4	7.50	8	5/8 X 3	3/4
6	250	8	9.50	8	3/4 X 3-1/2	7/8
8	200	8	11.75	8	3/4 X 3-1/2	7/8
10	175	12	14.25	12	7/8 X 4	1
12	150	12	17.00	12	7/8 X 4	1

DUCTILE IRON ADAPTER FLANGE

SIZE	CAST IRON PIPE OD $\pm .06$ OR $-.06$	D $\pm .06$ $-.04$	F $\pm .07$ $-.03$
3	3.96	4.94	4.06
4	4.80	6.02	4.90
6	6.90	8.12	7.00
8	9.05	10.27	9.15
10	11.10	12.34	11.20
12	13.20	14.44	13.30

All set screws are 5/8" 90 lb. torque head.

*Wall thickness Note: Installation suggestions are based on use with class 53 ductile iron pipe; results may vary if different classes or other pipe is used.

REDUCERS

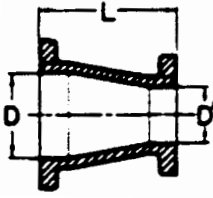

CONCENTRIC REDUCER

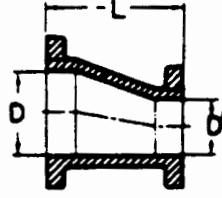

ECCENTRIC REDUCER

SIZE		DIMENSIONS	WTS
D	D1	L	
3	2	6	16
4	2	7	25
4	3	7	30
6	2	9	30
6	3	9	40
6	4	9	45
6	5	9	50
8	3	11	60
8	4	11	65
8	5	11	70
8	6	11	75
10	4	12	85
10	6	12	90
10	8	12	110
12	4	14	120
12	6	14	130
12	8	14	145
12	10	14	170
14	6	16	165
14	8	16	185
14	10	16	205
14	12	16	234
16	6	18	210
16	8	18	230
16	10	18	255
16	12	18	285
16	14	18	315
18	8	19	265
18	10	19	290
18	12	19	320
18	14	19	350
18	16	19	385
20	10	20	340
20	12	20	375
20	14	20	405
20	16	20	445
20	18	20	470
24	12	24	535
24	14	24	565
24	16	24	610
24	18	24	645
24	20	24	695
30	16	30	945
30	18	30	970
30	20	30	1035
30	24	30	1155

SIZE		DIMENSIONS	WTS
D	D1	L	
4	3	7	30
6	3	9	40
6	4	9	45
8	4	11	65
8	6	11	75
10	6	12	90
10	8	12	110
12	6	14	130
12	8	14	145
12	10	14	170
14	6	16	165
14	8	16	185
14	10	16	205
14	12	16	294
16	6	18	210
16	8	18	230
16	10	18	255
16	12	18	285
16	14	18	315
18	8	19	265
18	10	19	290
18	12	19	320
18	14	19	350
18	16	19	385
20	10	20	340
20	12	20	375
20	14	20	405
20	16	20	445
20	18	20	470
24	12	24	535
24	14	24	565
24	16	24	610
24	18	24	645
24	20	24	695

NOTE: Eccentric Reducer not included in AWWA C110

**DUCTILE IRON C110
FLANGED FITTINGS**
ANSI/AWWA C110/A21.10, ANSI/AWWA C111/A21.11

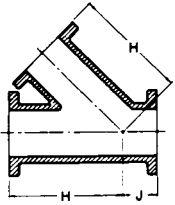

*45° Wye

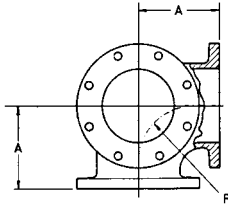

*90° Bend Side Outlet

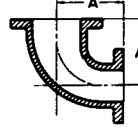

*90° Reducing Bend (1/4)

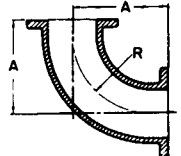

*90° Long Radius Bend (1/4)

SIZE		DIMENSIONS		WEIGHT
RUN	BRANCH	H	J	
3	3	10	3	45
4	3	12	3	65
4	4	12	3	75
5	4	13.5	3.5	93
5	5	13.5	3.5	96
6	3	14.5	3.5	105
6	4	14.5	3.5	105
6	5	14.5	3.5	120
6	6	14.5	3.5	115
8	3	17.5	4.5	165
8	4	17.5	4.5	165
8	6	17.5	4.5	175
8	8	17.5	4.5	200
10	4	20.5	5	240
10	6	20.5	5	250
10	8	20.5	5	275
10	10	20.5	5	300
12	4	24.5	5.5	355
12	6	24.5	5.5	370
12	8	24.5	5.5	395
12	10	24.5	5.5	420
12	12	24.5	5.5	460
14	6	27	6	500
14	8	27	6	525
14	10	27	6	555
14	12	27	6	600
14	14	27	6	640
16	6	30	6.5	655
16	8	30	6.5	680
16	10	30	6.5	715
16	12	30	6.5	755
16	14	30	6.5	800
16	16	30	6.5	850
18	8	32	7	820
18	10	32	7	855
18	12	32	7	895
18	14	32	7	940
18	16	32	7	990
18	18	32	7	1035
20	10	35	8	1095
20	12	35	8	1130
20	14	35	8	1170
20	16	35	8	1220
20	20	35	8	1345
24	14	40.5	9	1810
24	16	40.5	9	1890
24	18	40.5	9	1950
24	20	40.5	9	2040
24	24	40.5	9	2020

SIZE	DIMENSIONS		WEIGHT
	A	R	
3	5.5	...	34
4	6.5	4.5	60
5	7.5	...	75
6	8.0	6.0	95
8	9.0	7.0	150
10	11.0	9.0	235
12	12.0	10.0	335
14	14.0	...	470
16	15.0	...	620
18	16.5	...	760
20	18.0	...	970
24	22.0	...	1510

*Not included in AWWA C110

SIZE	DIMENSIONS	
	A	WEIGHT
4X3	6.5	35
6X4	8	55
8X4	9	75
8X6	9	90
10X6	11	125
10X8	11	150
12X6	12	165
12X8	12	190
12X10	12	220

*Not included in AWWA C110

SIZE	DIMENSIONS		WEIGHT
	R	A	
3	6.25	7.75	28
4	7	9	50
6	9.5	11.5	80
8	14	14	140
10	16.5	16.5	230
12	17	18	325
14	19	21.5	475
16	21.5	24	630

*Not included in AWWA C110

BASE BENDS, BASE TEES

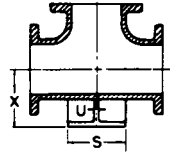
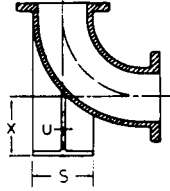
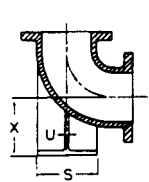

90° Base Bend (1/4) *90° Long Radius Base Bend (1/4) Base Tees

SIZE	DIMENSIONS			SUPPORT PIPE SIZE	90°	WEIGHT 90°LR	TEE
	X	S	U				
3	4.88	5	.50	1.5	35	38	50
4	5.5	6	.50	2	55	60	70
6	7	7	.62	2.5	85	100	115
8	8.38	9	.88	4	145	180	195
10	9.75	9	.88	4	210	275	315
12	11.25	11	1.00	6	300	390	450
14	12.5	11	1.00	6	400	580	570
16	13.75	11	1.00	6	505	740	710
18	15	13.5	1.12	8	645	...	900
20	16	13.5	1.12	8	805	...	1125
24	18.5	13.5	1.12	8	1215	...	1715
30	23	16	1.15	10	1945

*Not included in AWWA C110

*Not included in AWWA C110

Base Bends are made to order only, not returnable.

**DUCTILE IRON C110
FLANGED FITTINGS
ANSI/AWWA C110/A21.10, ANSI/AWWA C111/A21.11
*REDUCING BASE BENDS**

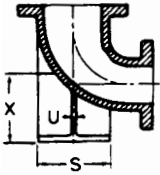

Base Under Large End

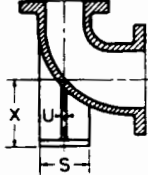

Base Under Small End

SIZE	DIMENSIONS		U	WEIGHT
	X	S		
4 X 3	5.5	6	.50	45
6 X 4	7	7	.62	75
8 X 4	8.38	9	.88	115
8 X 6	8.38	9	.88	135
10 X 6	9.75	9	.88	170
10 X 8	9.75	9	.88	195
12 X 6	11.25	11	1.00	230
12 X 8	11.25	11	1.00	255
12 X 10	11.25	11	1.00	285

*Not included in AWWA C110

FLANGES



Flange for Steel Pipe
Reducing Flange for Steel Pipe

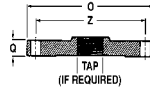

Under 12" Blind Flange
With Optional 2" Taps



Flange for DI Pipe
Reducing Flange for DI Pipe



12" and Larger Blind Flange
With Optional 2" Taps

SIZE	DIMENSIONS			WEIGHT			
	O	Q	Z	STEEL	DI	BLIND	BLIND TAP
2	6	.62	4.75	4	4
2-1/2	7	.69	5.50	6
3	7.5	.75	6.00	6	6	8	8
4	9	.94	7.50	10.8	10.8	14	14
6	11	1.00	9.50	14.1	14.1	25	25
8	13.5	1.12	11.75	25	25	40	40
10	16	1.19	14.25	32.4	32.4	60	60
12	19	1.25	...	47	47	80	80
14	21	1.38	72	110	110
16	23.5	1.44	90	145	145
18	25	1.56	90	190	190
20	27.5	1.69	115	225	225
24	32	1.88	160	370	370
30	38.75	2.12	240	580	580

*NOTE: All flanges conform to ANSI/AWWA C115/A21.15 Standards.

DI REDUCING FLANGE THREADED FOR STEEL PIPE			DI REDUCING FLANGE THREADED FOR CAST IRON PIPE		
TAP x O.D.	SIZE & TAP	WEIGHT	TAP x O.D.	SIZE & TAP	WEIGHT
3 X 9	(4 X 3)	16	3 X 9	(4 X 3)	16
4 X 11	(6 X 4)	21	4 X 11	(6 X 4)	25
4 X 13-1/2	(8 X 4)	37	4 X 13-1/2	(8 X 4)	40
6 X 13-1/2	(8 X 6)	31	6 X 13-1/2	(8 X 6)	35
6 X 16	(10 X 6)	50	8 X 16	(10 X 8)	50
6 X 19	(12 X 6)	60	8 X 19	(12 X 8)	85
8 X 16	(10 X 8)	55			
10 X 19	(12 X 10)	72			

**DUCTILE IRON C110
FLANGED FITTINGS
ANSI/AWWA C110/A21.10, ANSI/AWWA C111/A21.11
FLANGE AND FLARE**

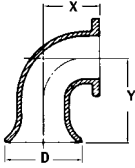

***Flange and Flare 90° Ell**

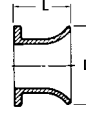

***Flange and Flare Piece**

SIZE	DIMENSIONS			WEIGHT
	D	X	Y	
3	7.5	5.5	8.5	25
4	9.0	6.5	9.5	40
6	11.0	8.0	12.0	70
8	13.5	9.0	13.0	110
10	16.0	11.0	15.0	175
12	19.0	12.0	16.0	245
14	21.0	14.0	22.0	450
16	23.5	15.0	23.0	454
18	25.0	16.5	24.5	675
20	27.5	18.0	26.0	860
24	32.0	22.0	30.0	1195
30	38.75	25.0	36.0	1565

SIZE	DIMENSIONS		WEIGHT
	D	L	
3	7.25	8	20
4	9.00	8	30
6	11.00	8	40
8	13.50	10	70
10	16.00	10	95
12	19.00	12	155
14	21.00	16	225
16	23.50	16	330
18	25.00	16	355
20	27.50	18	460
24	32.00	18	635

*Not included in AWWA C110

***TRUE WYE**

***FLANGE SLUDGE SHOE**

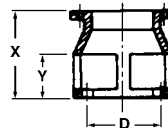
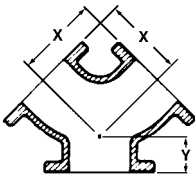

SIZE STEM BRANCHES		DIMENSIONS		WEIGHT
		X	Y	
3	3	5.5	3.0	30
4	3	5.5	3.0	35
4	4	6.5	3.0	50
6	3	5.5	3.5	55
6	4	8.0	3.5	75
6	6	8.0	3.5	80
8	4	6.5	4.5	85
8	6	9.0	4.5	120
8	8	9.0	4.5	125
10	6	8.0	5.0	140
10	8	9.0	5.0	155
10	10	11.0	5.0	220
12	6	8.0	5.5	160
12	8	9.0	5.5	210
12	10	11.0	5.5	240
12	12	12.0	5.5	315

SIZE	DIMENSIONS			WEIGHT
	D	X	Y	
3	5.75	12	6	25
4	7.00	12	6	35
6	7.87	12	6	45
8	10.12	12	6	65
10	12.25	12	6	85
12	15.25	12	6	120

*Not included in AWWA C110.

*Not included in AWWA C110.

METHOD OF DESIGNATING LOCATION OF TAPPED HOLES AND/OR BOSSES IN CAST IRON FLANGED FITTINGS

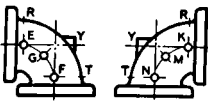

90° Elbow
Straight Size

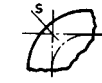

90° Elbow

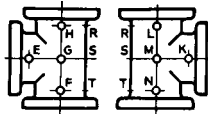

Tee
Straight Size

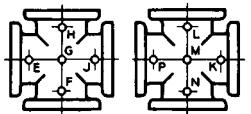

Cross
Straight Size

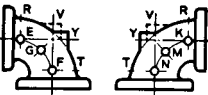

90° Elbow
Reducing Size

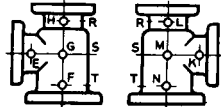

Tee
Reducing Size

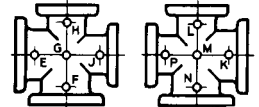

Cross
Reducing Size

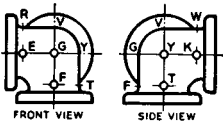

Side Outlet Elbow
Straight Size

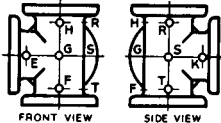

Side Outlet Tee
Straight Size

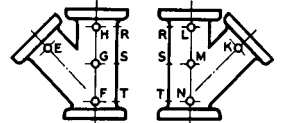

45° Lateral
Straight Size

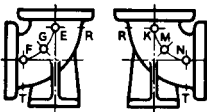

90° Base Elbow

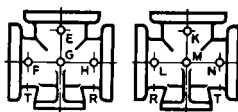

Base Tee

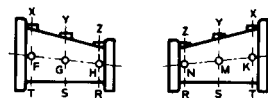

Eccentric Reducer

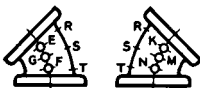

45° Elbow

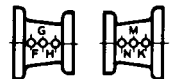

Reducer

When a cast iron flanged fitting is wanted with a tapped connection, give the size of the tapping required, and designate its location by means of a letter selected from the correct view of the fitting in question.

Tapping through the wall of the fitting is limited to the sizes indicated in the table. Larger size tapped openings will require casting the fittings with an integral boss - the location of which may also be identified by a letter, as explained above. A boss is always required at "V" and "Y" on straight and reducing sizes of 90-degree elbows, and on tapered sides of reducers.

MAXIMUM SIZE OF TAPPED HOLE IN FITTING

SIZE OF FITTING-INCHES	3	4	5	6	8	10	12	14-30
SIZE OF HOLE WITHOUT BOSS-INCHES	3/8	3/8	3/8	1/2	3/4	1	1-1/2	2
SIZE OF HOLE WITH BOSS-INCHES	2	2-1/2	2-1/2	3	4	4	4	4

**DUCTILE IRON C153
UNION-TITE PUSH-ON FITTINGS
ANSI/AWWA C153/A21.53**

SAMPLE SPECIFICATIONS

4" THRU 24" PUSH-ON FITTINGS shall be ductile iron and shall be produced in accordance with all applicable provisions of ANSI/AWWA C153/A21.53 and shall conform to details and dimensions published therein. All other items not listed in those Standards shall be produced to Manufacturer's Standards. Joints shall be in accordance with ANSI/AWWA C111/A21.11 with bell sockets designed to receive pressure pipe O.D.'s as specified in ANSI/AWWA C151/A21.51 and AWWA C900 TABLE 2. Fittings should be cement lined and seal coated in accordance with ANSI/AWWA C104/A21.4.

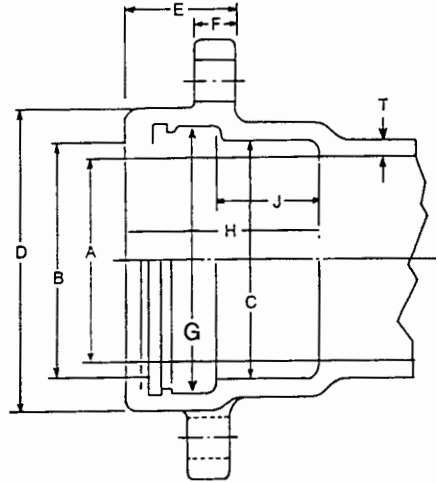
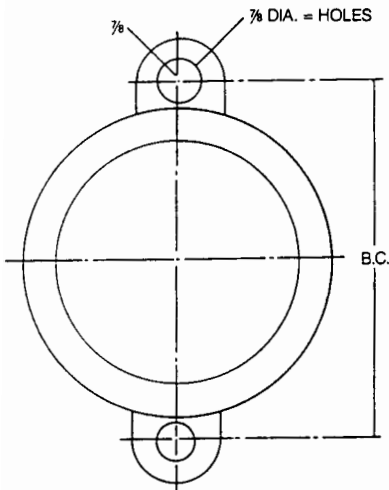

BELL SPECIFICATIONS

SIZE	DIMENSIONS										
	A	B	C	D	B.C.*	H	J	E*	F	G	T
3	-	-	-	-	-	-	-	-	-	-	-
4	4.30	4.91	5.04	6.38	7.88	4.16	2.25	2.12	.87	5.64	.35
6	6.36	7.01	7.14	8.52	10.50	4.29	2.25	2.14	.87	7.74	.37
8	8.52	9.17	9.32	10.90	12.88	4.78	2.25	2.69	1.00	9.98	.39
10	10.58	11.22	11.37	12.91	14.69	4.98	2.25	2.89	1.12	12.03	.41
12	12.64	13.32	13.47	15.12	17.19	4.98	2.25	3.00	1.12	14.13	.43
14	14.28	15.41	15.64	18.12	-	5.40	2.25	-	-	16.64	.51
16	16.36	17.51	17.74	20.32	-	5.40	2.25	-	-	18.74	.52
18	18.32	19.61	19.83	22.52	-	5.40	2.25	-	-	20.84	.59
20	20.40	21.71	21.94	24.29	-	5.40	2.25	-	-	22.94	.60
24	24.56	25.91	26.14	29.14	-	5.65	2.50	-	-	27.18	.62

*Restraining lugs are provided only on sizes 12" and smaller. Lugs can be provided on 14" and larger sizes upon special request.

Maximum deflection for all sizes is 5°.

**DUCTILE IRON C153
UNION-TITE PUSH-ON FITTINGS
ANSI/AWWA C153/A21.53**

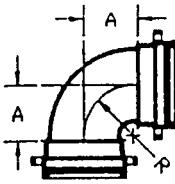

UT x UT
1/4 BEND

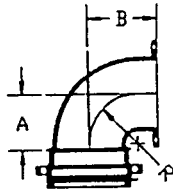

UT x FE*
1/4 BEND

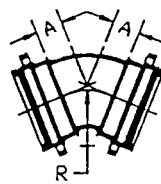

UT x UT
1/8 BEND

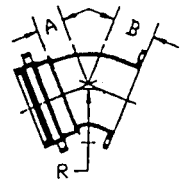

UT x FE*
1/8 BEND

1/4 BENDS

SIZE	PRESSURE RATING PSI**	DIMENSIONS			WEIGHT	
		A	B	R	UT x UT	UT x FE
3	-	-	-	-	-	-
4†	350	4.5	6.5	3.87	24	31
6†	350	6.0	7.0	5.37	51	49
8	350	7.0	9.0	6.37	79	74
10	350	9.0	10.0	8.36	121	130
12	350	10.0	12.0	9.36	145	158
14	350	12.0	15.5	10.98	254	159
16	350	13.0	16.5	12.00	328	233
18	350	15.5	-	14.00	482	-
20	350	17.0	-	15.50	340	-
24	350	17.0	-	15.59	674	-

1/8 BENDS

SIZE	PRESSURE RATING PSI**	DIMENSIONS			WEIGHT	
		A	B	R	UT x UT	UT x FE
3	-	-	-	-	-	-
4†	350	2.0	4.0	3.31	25	21
6†	350	3.0	5.0	5.72	42	42
8†	350	3.5	5.5	6.93	64	60
10	350	4.5	6.5	9.34	89	93
12	350	5.5	7.5	11.75	120	122
14	350	5.5	8.5	10.85	143	162
16	350	6.0	9.5	12.02	225	275
18	350	6.5	-	12.36	209	-
20	350	7.0	-	13.59	397	-
24	350	7.5	-	14.69	492	-

* Not included in AWWA C153. Produced to Manufacturer's Standards.

** Pressure rating for fittings with Flange openings is limited to 250 psi.

Weight does not include accessories weight or cement lining weight.

† Also available UT x Plain-end.

**DUCTILE IRON C153
UNION-TITE PUSH-ON FITTINGS
ANSI/AWWA C153/A21.53**

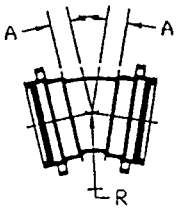

UT x UT
1/16 BEND

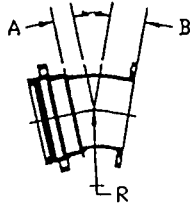

UT x FE*
1/16 BEND

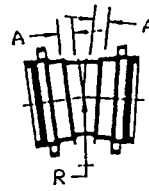

UT x UT
1/32 BEND

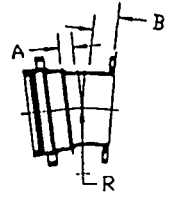

UT x FE*
1/32 BEND

1/16 BENDS

SIZE	PRESSURE RATING PSI**	DIMENSIONS			WEIGHT	
		A	B	R	UT x UT	UT x FE
3	-	-	-	-	-	-
4	350	1.5	3.5	4.38	18	25
6†	350	2.25	4.3	8.16	39	44
8†	350	2.5	4.5	9.40	61	64
10	350	3.0	5.3	13.17	67	90
12	350	3.5	5.5	14.42	106	112
14	350	3.75	6.8	13.82	162	174
16	350	4.0	7.5	14.97	195	228
18	350	7.5	-	30.19	209	-
20	350	8.5	-	35.19	414	-
24	350	9.0	-	37.69	596	-

1/32 BENDS

SIZE	PRESSURE RATING PSI**	DIMENSIONS			WEIGHT	
		A	B	R	UT x UT	UT x FE
3	-	-	-	-	-	-
4†	350	1.25	3.3	6.77	18	24
6†	350	1.5	3.5	9.38	40	30
8	350	1.75	3.75	11.48	59	61
10	350	2.0	4.0	13.95	77	80
12	350	2.25	4.3	16.50	94	94
14	350	2.6	5.75	14.26	113	170
16	350	2.6	6.1	15.23	172	228
18	350	3.0	-	60.94	209	-
20	350	3.5	-	71.07	265	-
24	350	-	-	-	-	-

* Not included in AWWA C153. Produced to Manufacturer's Standards.

** Pressure rating for fittings with Flange openings is limited to 250 psi.

Weight does not include accessories weight or cement lining weight.

†Also available UT x Plain-end.

**DUCTILE IRON C153
UNION-TITE PUSH-ON FITTINGS
ANSI/AWWA C153/A21.53**

TEES

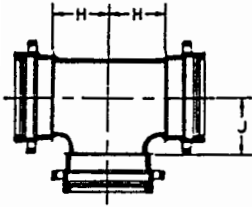

UT x UT

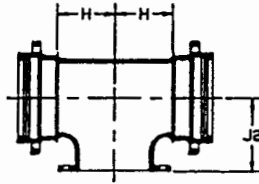

UT x FE*

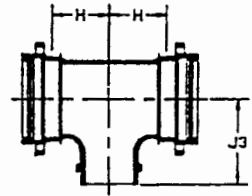

UT x SWV*

SIZE	PRESSURE RATING PSI**	DIMENSIONS				WEIGHT		
		H	J	J2	J3	UT x UT	UT x FE	UT x SWV
3	-	-	-	-	-	-	-	-
4 X 3	-	-	-	-	-	-	-	-
4	350	4.5	4.5	6.5	-	44	45	-
6 X 3	-	-	-	-	-	-	-	-
6 X 4	350	5.0	6.0	8.0	-	68	56	-
6	350	6.0	6.0	8.0	9.5	71	70	65
8 X 4	350	5.0	7.0	9.0	-	73	89	-
8 X 6	350	6.0	7.0	9.0	10.5	96	97	100
8	350	7.0	7.0	9.0	10.5	111	111	110
10 X 4	350	6.0	9.0	11.0	-	102	115	-
10 X 6	350	7.0	9.0	11.0	12.5	113	127	130
10 X 8	350	8.0	9.0	11.0	12.5	145	145	156
10	350	9.0	9.0	11.0	-	155	158	-
12 X 4	350	6.0	10.0	12.0	-	119	138	-
12 X 6	350	7.0	10.0	12.0	13.5	159	166	162
12 X 8	350	8.0	10.0	12.0	13.5	177	170	158
12 X 10	350	9.0	10.0	12.0	-	160	162	-
12	350	10.0	10.0	12.0	-	217	183	-
14 X 6	350	6.5	10.5	12.5	14.0	176	212	202
14 X 8	350	-	-	-	-	-	-	-
14 X 10	350	8.5	10.5	12.5	-	195	246	-
14 X 12	350	9.5	10.5	12.5	-	196	296	-
14	350	10.5	10.5	14.0	-	209	321	-
16 X 6	350	6.5	11.5	13.5	15.0	266	246	229
16 X 8	350	7.5	11.5	13.5	15.0	292	270	292
16 X 10	350	8.5	11.5	13.5	-	232	330	-
16 X 12	350	9.5	11.5	13.5	-	239	321	-
16 X 14	350	10.5	11.5	15.0	-	349	342	-
16	350	11.5	11.5	15.0	-	390	355	-

* Not included in AWWA C153. Produced to Manufacturer's Standards.

** Pressure rating for fittings with Flange openings is limited to 250 psi.

Weight does not include accessories weight or cement lining weight.

**DUCTILE IRON C153
UNION-TITE PUSH-ON FITTINGS
ANSI/AWWA C153/A21.53**

**TEES
(Continued)**

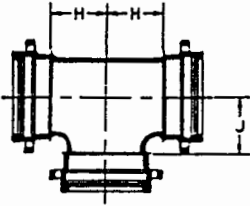

UT x UT

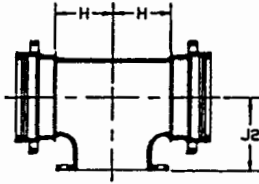

UT x FE*

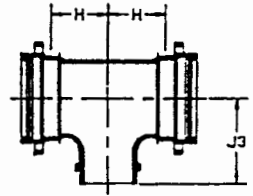

UT x SWV*

SIZE	PRESSURE RATING PSI**	DIMENSIONS				WEIGHT		
		H	J	J2	J3	UT x UT	UT x FE	UT x SWV
18 X 6	350	6.5	12.5	14.5	16.13	348	301	348
18 X 8	350	7.5	12.5	14.5	16.13	325	319	324
18 X 10	350	8.5	12.5	14.5	-	344	337	-
18 X 12	-	-	-	-	-	-	-	-
18 X 14	350	10.5	12.5	16.0	-	342	393	-
18 X 16	350	11.5	12.5	16.0	-	362	420	-
18	-	-	-	-	-	-	-	-
20 X 6	350	7.0	14.0	16.0	17.5	355	341	400
20 X 8	-	-	-	-	-	-	-	-
20 X 10	350	9.0	14.0	16.0	-	369	420	-
20 X 12	-	-	-	-	-	-	-	-
20 X 14	350	11.0	14.0	17.5	-	484	474	-
20 X 16	350	12.0	14.0	17.5	-	610	498	-
20 X 18	350	13.0	14.0	17.5	-	539	528	-
20	-	-	-	-	-	-	-	-
24 X 6	350	7.0	16.0	18.0	19.5	385	512	525
24 X 8	-	-	-	-	-	-	-	-
24 X 10	350	9.0	16.0	18.0	-	478	468	-
24 X 12	350	10.0	16.0	18.0	-	663*	503	-
24 X 14	350	11.0	16.0	19.5	-	542	531	-
24 X 16	350	12.0	16.0	19.5	-	566	555	-
24 X 18	350	13.0	16.0	-	-	593	-	-
24 X 20	350	15.0	17.0	-	-	628	-	-
24	350	17.0	17.0	-	-	884	-	-

* Not included in AWWA C153. Produced to Manufacturer's Standards.

** Pressure rating for fittings with Flange openings is limited to 250 psi.

Weight does not include accessories weight or cement lining weight.

**DUCTILE IRON C153
UNION-TITE PUSH-ON FITTINGS
ANSI/AWWA C153/A21.53**

REDUCERS

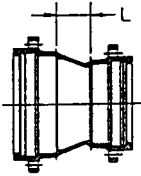

UT x UT

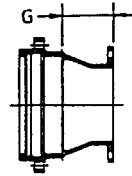

UT x FE*

SIZE	PRESSURE RATING PSI**	DIMENSIONS		WEIGHT		SIZE	PRESSURE RATING PSI**	DIMENSIONS		WEIGHT	
		L	G	UT x UT	UT x FE			L	G	UT x UT	UT x FE
4 X 3	-	-	-	-	-	18 X 8	350	14.0	16.0	142	157
6 X 3	-	-	-	-	-	18 X 10	350	12.0	14.0	151	175
6 X 4	350	4.0	6.0	37	32	18 X 12	350	10.0	12.0	167	215
8 X 4	350	5.0	7.0	46	46	18 X 14	350	8.0	11.5	217	234
8 X 6	350	4.0	6.0	52	47	18 X 16	350	7.0	10.5	202	246
10 X 4	350	7.0	9.0	47	55	20 X 10	350	14.0	16.0	180	234
10 X 6	350	5.0	7.0	47	59	20 X 12	350	12.0	-	205	-
10 X 8	350	4.0	6.0	53	61	20 X 14	350	10.0	13.5	233	249
12 X 4	350	9.0	11.0	80	78	20 X 16	350	8.0	11.5	250	272
12 X 6	350	7.0	9.0	58	73	20 X 18	350	7.0	-	248	-
12 X 8	350	5.0	7.0	74	74	24 X 12	350	16.0	18.0	246	262
12 X 10	350	4.0	6.0	82	95	24 X 14	350	14.0	17.5	281	315
14 X 6	350	9.0	11.0	84	121	24 X 16	350	12.0	15.5	380	328
14 X 8	350	7.0	9.0	85	128	24 X 18	350	10.0	-	390	-
14 X 10	350	5.0	7.0	87	127	24 X 20	350	8.0	-	421	-
14 X 12	350	4.0	6.0	104	144						
16 X 6	350	11.0	13.0	94	133						
16 X 8	350	9.0	11.0	104	141						
16 X 10	350	7.0	9.0	130	158						
16 X 12	350	5.0	7.0	152	172						
16 X 14	350	4.0	6.0	139	196						

* Not included in AWWA C153. Produced to Manufacturer's Standards.

** Pressure rating for fittings with Flange openings is limited to 250 psi.

Weight does not include accessories weight or cement lining weight.

**DUCTILE IRON C153
UNION-TITE PUSH-ON FITTINGS
ANSI/AWWA C153/A21.53**



UT x FE ADAPTOR*

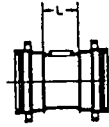

UT TAPPED TEE/CROSS*

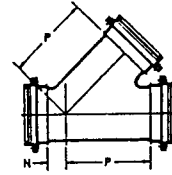

UT WYE*

UT x FE ADAPTOR

SIZE	PRESSURE RATING PSI	L	WEIGHT
3	-	-	-
4	250	6.0	30
6	250	6.0	36
8	250	6.0	54
10	250	6.0	71
12	250	6.0	92
14	250	7.0	173
16	250	7.0	115
18	-	-	-
20	250	6.0	295
24	-	-	-

UT TAPPED TEE / CROSS

SIZE	PRESSURE RATING PSI	MAX SIZE TAP	L	WEIGHT
3	-	-	-	-
4	350	3.0	6.0	27
6	350	3.5	6.0	38
8	350	3.5	6.0	59
10	350	3.5	6.0	72
12	350	3.5	6.0	92
16	-	-	-	-
18	-	-	-	-
20	-	-	-	-
24	-	-	-	-

WYES

SIZE	PRESSURE RATING PSI	P	N	WEIGHT	SIZE	PRESSURE RATING PSI	P	N	WEIGHT
3	-	-	-	-	12 X 4	NR	16.5	0	178
4 X 3	-	-	-	-	12 X 6	NR	18.5	1.5	201
4	-	-	-	-	12 X 8	NR	18.5	1.5	224
6 X 3	-	-	-	-	12 X 10	NR	20.0	3.0	239
6 X 4	-	-	-	-	12	NR	20.0	5.0	289
6	-	-	-	-	14 X 6	NR	19.5	0	236
8 X 4	NR	13.5	0	89	14 X 8	NR	21.0	1.5	255
8 X 6	-	-	-	-	14 X 10	NR	22.5	3.0	325
8	-	-	-	-	14	NR	25.0	6.0	475
10 X 4	NR	15.0	0	141	16 X 6	NR	21.0	0	281
10 X 6	NR	16.0	1.0	151	16 X 8	NR	22.5	0.5	304
10 X 8	NR	17.0	2.5	175	16 X 12	NR	25.0	3.5	346
10	NR	18.0	4.0	200	16	NR	28.0	6.5	380

* Not included in AWWA C153. Produced to Manufacturer's Standards.

NR = Not pressure rated. Contact manufacturer for recommended pressure for application.

Weight does not include accessories weight or cement lining weight.

**DUCTILE IRON C153
UNION-TITE PUSH-ON FITTINGS
ANSI/AWWA C153/A21.53**

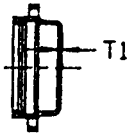

UT CAP*

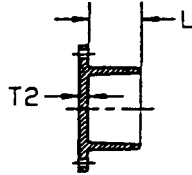

UT PLUG*

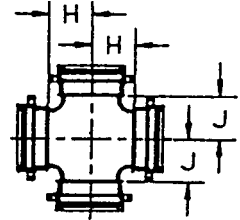

UT CROSS

CAPS AND PLUGS

SIZE	PRESSURE RATING PSI	DIMENSIONS			MAX. TAP SIZE	WEIGHT	
		T1	T2	L		CAP	PLUG
3	350	-	-	-	-	-	-
4	350	.48	.50	5.25	3.0	15	8
6	350	.48	.50	5.25	3.0	20	23
8	350	.51	.53	5.25	4.0	35	32
10	350	.53	.56	5.25	4.0	50	38
12	350	.55	.62	5.25	4.0	75	49

CROSSES

SIZE	PRESSURE RATING PSI	H	J	WEIGHT	SIZE	PRESSURE RATING PSI	H	J	WEIGHT
3	-	-	-	-	14 X 6	350	6.5	10.5	189*
4 X 3	-	-	-	-	14 X 8	350	7.5	10.5	204*
4	-	-	-	-	14 X 10	350	8.5	10.5	222*
6 X 3	-	-	-	-	14 X 12	350	9.5	10.5	239*
6 X 4	-	-	-	-	14	350	10.5	10.5	270
6	350	6.0	6.0	88	16 X 6	350	6.5	11.5	234*
8 X 4	-	-	-	-	16 X 8	350	7.5	11.5	323*
8 X 6	350	6.0	7.0	117*	16 X 10	350	8.5	11.5	268*
8	350	7.0	7.0	156	16 X 12	350	9.5	11.5	274*
10 X 4	350	6.0	9.0	116*	16 X 14	350	10.5	11.5	322*
12 X 4	-	-	-	-	16	350	11.5	11.5	317
12 X 8	350	8.0	10.0	240					
12 X 10	-	-	-	-					
12	350	10.0	10.0	241					

*Not included in AWWA C153. Produced to Manufacturer's Standards.

NOTE: Furnished with Union-tite bell on all openings unless ordered otherwise.
Weight does not include accessories weights or cement lining weight.

**CLOW SUPER-LOCK® FITTINGS
SPECS
ANSI/AWWA C110/A21.10**

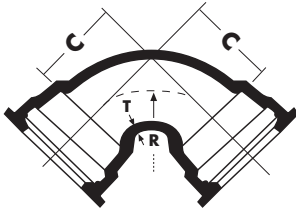

(90°) 1/4 Bend

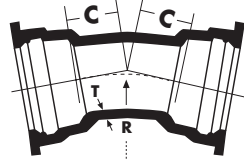

(22 1/2°) 1/16 Bend

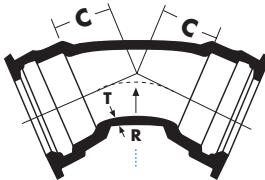

(45°) 1/8 Bend

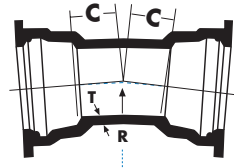

(11 1/4°) 1/32 Bend

SIZE	C	T	1/4 BEND (90°)		SIZE	C	T	1/8 BEND (45°)		1/16 BEND (22 1/2°)		1/32 BEND (11 1/4°)	
			R	Wt.				R	Wt.	R	Wt.	R	Wt.
6	8	.55	6	85	6	5	.55	7 1/4	75	15 1/16	75	30 1/2	75
8	9	.60	7	140	8	5 1/2	.60	8 7/16	120	17 5/8	120	35 1/2	120
10	11	.68	9	200	10	6 1/2	.68	10 7/8	155	22 5/8	165	45 11/16	165
12	12	.75	10	270	12	7 1/2	.75	13 1/4	225	27 5/8	230	55 13/16	230
14	14	.66	11 1/2	320	14	7 1/2	.66	12 1/16	250	25 1/8	255	50 3/4	255
16	15	.70	11 1/2	405	16	8	.70	13 1/4	315	27 5/8	320	55 13/16	320
18	16 1/2	.75	14	515	18	8 1/2	.75	14 1/2	395	30 3/16	400	60 15/16	400
20	18	.80	15 1/2	645	20	9 1/2	.80	16 7/8	495	35 3/16	500	71 1/16	505
24	22	.89	18 1/2	985	24	11	.89	18 1/8	715	37 11/16	725	76 1/8	730
30	25	1.03	21 1/2	1560	30	15	1.03	27 3/4	1250	57 13/16	1270	116 3/4	1280

Rated working pressure is 350 psi for 6" - 24". Super-Lock® fittings (250 psi for 30").

**CLOW SUPER-LOCK® FITTINGS
SPECS
ANSI/AWWA C110/A21.10**

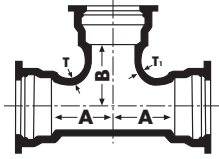

Tee

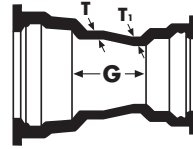

Reducer

SIZE RUN	BRANCH	A	B	T	T1	WEIGHT
6	6	8	8	.55	.55	125
8	6	9	9	.60	.55	185
8	8	9	9	.60	.60	205
10	6	11	11	.68	.55	255
10	8	11	11	.68	.60	275
10	10	11	11	.8	.80	330
12	6	12	12	.75	.55	335
12	8	12	12	.75	.60	355
12	10	12	12	.87	.80	405
12	12	12	12	.87	.87	425
14	6	14	14	.66	.55	395
14	8	14	14	.66	.60	415
14	10	14	14	.66	.68	435
14	12	14	14	.66	.75	460
14	14	14	14	.66	.66	470
16	6	15	15	.70	.55	490
16	8	15	15	.70	.60	510
16	10	15	15	.70	.68	525
16	12	15	15	.70	.75	550
16	14	15	15	.70	.66	560
16	16	15	15	.70	.70	535
18	6	13	15 1/2	.75	.55	540
18	8	13	15 1/2	.75	.60	560
18	10	13	15 1/2	.75	.68	575
18	12	13	15 1/2	.75	.75	590
18	14	16 1/2	16 1/2	.75	.66	585
18	16	16 1/2	16 1/2	.75	.70	715
18	19	16 1/2	16 1/2	.75	.75	745
20	6	14	17	.80	.55	560
20	8	14	17	.80	.60	680
20	10	14	17	.80	.68	695
20	12	14	17	.80	.75	715
20	14	14	17	.80	.66	720
20	16	18	18	.80	.70	860
20	18	18	18	.80	.75	895
20	20	18	18	.80	.80	930
24	6	15	19	.89	.55	910
24	8	15	19	.89	.60	925
24	10	15	19	.89	.68	940
24	12	15	19	.89	.75	955
24	14	15	19	.89	.66	930
24	16	15	19	.89	.70	860
24	18	22	22	.89	.75	1295
24	20	22	22	.89	.80	1340
24	24	22	22	.89	.89	1415
30	6	18	23	1.03	.55	1475
30	8	18	23	1.03	.60	1490
30	10	18	23	1.03	.68	1505
30	12	18	23	1.03	.75	1525
30	14	18	23	1.03	.66	1525
30	16	18	23	1.03	.70	1545
30	18	18	23	1.03	.75	1565
30	20	18	23	1.03	.80	1590
30	24	25	25	1.03	.89	2070
30	30	25	25	1.03	1.03	2210

SIZE	G	T	T1	WEIGHT
8 X 6	11	.60	.55	100
10 X 6	12	.68	.55	120
10 X 8	12	.68	.60	145
12 X 6	14	.75	.55	155
12 X 8	14	.75	.60	180
12 X 10	14	.75	.68	200
14 X 6	16	.66	.55	180
14 X 8	16	.66	.60	205
14 X 10	16	.66	.68	225
14 X 12	16	.66	.75	250
16 X 6	18	.70	.55	215
16 X 8	18	.70	.60	245
16 X 10	18	.70	.68	270
16 X 12	18	.70	.75	300
16 X 14	18	.70	.66	310
18 X 8	19	.75	.60	290
18 X 10	19	.75	.68	315
18 X 12	19	.75	.75	345
18 X 14	19	.75	.66	355
18 X 16	19	.75	.70	385
20 X 10	20	.80	.68	365
20 X 12	20	.80	.75	395
20 X 14	20	.80	.66	405
20 X 16	20	.80	.70	440
20 X 18	20	.80	.75	475
24 X 12	24	.89	.75	535
24 X 14	24	.89	.66	545
24 X 16	24	.89	.70	580
24 X 18	24	.89	.75	625
24 X 20	24	.89	.80	670
30 X 16	30	1.03	.70	860
30 X 18	30	1.03	.75	910
30 X 20	30	1.03	.80	965
30 X 24	30	1.03	.89	1075

**CLOW SUPER-LOCK® FITTINGS
SPECS
ANSI/AWWA C110/A21.10**

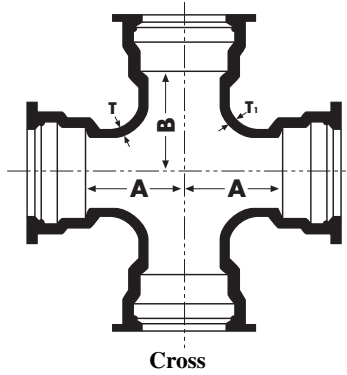

SIZE RUN	BRANCH	A	B	T	T1	WEIGHT	SIZE RUN	BRANCH	A	B	T	T1	WEIGHT
6	6	8	8	.55	.55	160	20	6	14	17	.80	.55	695
8	6	9	9	.60	.55	215	20	8	14	17	.80	.60	735
8	8	9	9	.60	.60	255	20	10	14	17	.80	.68	765
10	6	11	11	.68	.55	290	20	12	14	17	.80	.75	805
10	8	11	11	.68	.60	330	20	14	14	17	.80	.66	815
10	10	11	11	.80	.80	395	20	16	18	18	.80	.70	985
12	6	12	12	.75	.55	370	20	18	18	18	.80	.75	1050
12	8	12	12	.75	.60	405	20	20	18	18	.80	.80	1115
12	10	12	12	.87	.80	475	24	6	15	19	.89	.55	940
12	12	12	12	.87	.87	515	24	8	15	19	.89	.60	980
14	6	14	14	.66	.55	435	24	10	15	19	.89	.68	1005
14	8	14	14	.66	.60	475	24	12	15	19	.89	.75	1040
14	10	14	14	.66	.68	510	24	14	15	19	.89	.66	1050
14	12	14	14	.66	.75	555	24	16	15	19	.89	.70	1085
14	14	14	14	.66	.66	575	24	18	22	22	.89	.75	1460
16	6	15	15	.70	.55	530	24	20	22	22	.89	.80	1635
16	8	15	15	.70	.60	570	24	24	22	22	.89	.89	1685
16	10	15	15	.70	.68	600	30	6	23	23	1.03	.55	1510
16	12	15	15	.70	.75	645	30	8	23	23	1.03	.60	1545
16	14	15	15	.70	.66	660	30	10	23	23	1.03	.68	1575
16	16	15	15	.70	.70	710	30	12	23	23	1.03	.75	1610
18	6	13	15 1/2	.75	.55	575	30	14	23	23	1.03	.66	1615
18	8	13	15 1/2	.75	.60	610	30	16	23	23	1.03	.70	1650
18	10	13	15 1/2	.75	.68	640	30	18	23	23	1.03	.75	1695
18	12	13	15 1/2	.75	.75	680	30	20	23	23	1.03	.80	1745
18	14	16 1/2	16 1/2	.75	.66	790	30	24	25	25	1.03	.89	2775
18	16	16 1/2	16 1/2	.75	.70	840	30	30	25	25	1.03	1.03	3105
18	18	16 1/2	16 1/2	.75	.75	900

**CLOW SUPER-LOCK® FITTINGS
SPECS
ANSI/AWWA C110/A21.10**

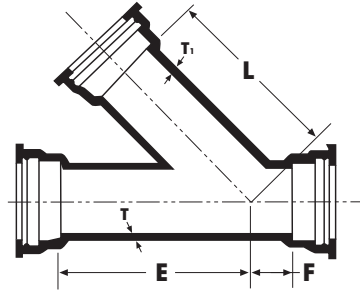

WYE Branch

SIZE RUN	BRANCH	L	E	F	T	T1	WEIGHT	SIZE RUN	BRANCH	L	E	F	T	T1	WEIGHT
6	6	14.5	14.5	3.5	.55	.55	145	20	6	29.5	27.0	1.0	1.03	.55	1085
8	6	17.5	17.5	4.5	.60	.55	205	20	8	29.5	27.0	1.0	1.03	.60	1140
8	8	17.5	17.5	4.5	.60	.60	230	20	10	29.5	27.0	1.0	1.03	.68	1200
10	6	20.5	20.5	5.0	.68	.55	285	20	12	35.0	35.0	8.0	1.03	.75	1260
10	8	20.5	20.5	5.0	.68	.60	310	20	14	35.0	35.0	8.0	1.03	.82	1320
10	10	20.5	20.5	5.0	.68	.68	340	20	16	35.0	35.0	8.0	1.03	.89	1375
12	6	24.5	24.5	5.5	.75	.55	400	20	18	35.0	35.0	8.0	1.03	.96	1445
12	8	24.5	24.5	5.5	.75	.60	425	20	20	35.0	35.0	8.0	1.03	1.03	1525
12	10	24.5	24.5	5.5	.75	.68	450	24	6	34.5	31.5	0.5	1.16	.55	1625
12	12	24.5	24.5	5.5	.75	.75	490	24	8	34.5	31.5	0.5	1.16	.60	1685
14	6	27.0	27.0	6.0	.82	.55	570	24	10	34.5	31.5	0.5	1.16	.68	1745
14	8	27.0	27.0	6.0	.82	.60	595	24	12	34.5	31.5	0.5	1.16	.75	1805
14	10	27.0	27.0	6.0	.82	.68	625	24	14	40.5	40.5	9.0	1.16	.82	1865
14	12	27.0	27.0	6.0	.82	.75	670	24	16	40.5	40.5	9.0	1.16	.89	1925
14	14	27.0	27.0	6.0	.82	.82	730	24	18	40.5	40.5	9.0	1.16	.96	1990
16	6	30.0	30.0	6.0	.89	.55	735	24	20	40.5	40.5	9.0	1.16	1.03	2070
16	8	30.0	30.0	6.5	.89	.60	760	24	24	40.5	40.5	9.0	1.16	1.16	2245
16	10	30.0	30.0	6.5	.89	.68	800	30	6	42.0	39.0	0.0	1.37	.56	2845
16	12	30.0	30.0	6.5	.89	.75	835	30	8	42.0	39.0	0.0	1.37	.63	2890
16	14	30.0	30.0	6.5	.89	.82	900	30	10	42.0	39.0	0.0	1.37	.75	2940
16	16	30.0	30.0	6.5	.89	.89	965	30	12	42.0	39.0	0.0	1.37	.81	2990
18	6	27.5	25.0	1.0	.96	.55	890	30	14	42.0	39.0	0.0	1.37	.88	3045
18	8	27.5	25.0	1.0	.96	.60	930	30	16	49.0	49.0	10	1.37	1.00	3105
18	10	32	32	7.0	.96	.68	975	30	18	49.0	49.0	10	1.37	1.06	3175
18	12	32	32	7.0	.96	.75	1015	30	20	49.0	49.0	10	1.37	1.13	3255
18	14	32	32	7.0	.96	.82	1075	30	24	49.0	49.0	10	1.37	1.25	3425
18	16	32	32	7.0	.96	.89	1135	30	30	49.0	49.0	10	1.37	1.37	3740
18	18	32	32	7.0	.96	.96	1200

**COMPACT FLANGED FITTINGS
DUCTILE IRON
Pressure Rating 250 Psi
Manufacturer's Standard**

SAMPLE SPECIFICATION

3" - 12" Compact Flanged Fittings shall be ductile iron Grade 70-50-05, and shall be produced in accordance with laying lengths specified in ANSI/AWWA C110/A21.10. Flange surface shall be faced and drilled in accordance with ANSI Class 125 B16.1. Nominal body thicknesses shall be Manufacturer's Standard, but shall not be less than those specified in ANSI/AWWA C153/A21.53 "Standards for Ductile Iron Compact Fittings". Flange thickness shall be in accordance with Manufacturer's Standards. Working Pressure Rating shall be 250 PSI. Fittings shall be made in the United States of America and shall not have been refurbished or re-worked by anyone other than the manufacturer.

Standard Class 125 template for drilling shall be used for all flanges. Drilling templates shall be in multiples of four, so that fittings may be made to face in any quarter. Bolt holes shall straddle the center line and shall be equally spaced. Misalignment of bolt holes of two opposing flanges shall not exceed 0.12 inches.

All fittings shall be in accordance with NSF-61. Interiors shall be lined and seal coated in accordance with ANSI/AWWA C104/A21.04 "Cement-mortar Lining for Ductile Iron Pipe and Fittings for Water" unless otherwise specified by the user.

Fittings are furnished without joint material.



**COMPACT FLANGED FITTINGS
DUCTILE IRON
Pressure Rating 250 Psi
Manufacturer's Standard**

COMPACT FLANGE DETAIL

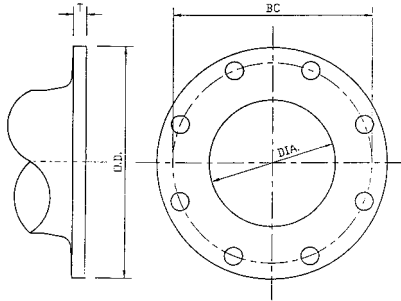

DIAMETER	DIMENSION IN INCHES				
	O.D.	BC	T (+.06-.00)	BOLT HOLE DIAMETER	NO. OF BOLTS
3	7.50	6.00	0.60	3/4	4
4	9.00	7.50	0.63	3/4	8
6	11.00	9.50	0.63	7/8	8
8	13.50	11.75	0.70	7/8	8
10	16.00	14.25	0.75	1	12
12	19.00	17.00	0.81	1	12

BENDS

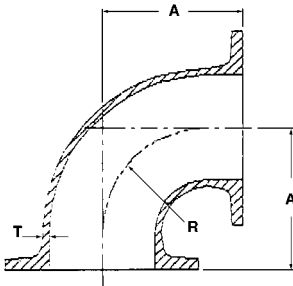

Flanged Compact 90° (1/4) Bend

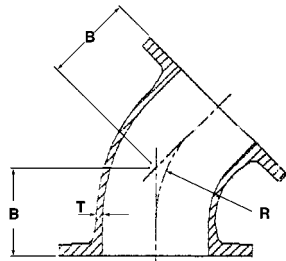

Flanged Compact 45° (1/8) Bend

SIZE	FLANGED COMPACT 90° (1/4) BENDS				FLANGED COMPACT 45° (1/8) BENDS			
	DIMENSIONS IN INCHES			WT. (LBS.)	DIMENSIONS IN INCHES			WT. (LBS.)
	T	A	R		T	B	R	
3	0.34	5.50	4.00	23	-	-	-	-
4	0.35	6.50	4.50	32	0.35	4.00	4.81	28
6	0.37	8.00	6.00	56	0.37	5.00	7.25	41
8	0.39	9.00	7.00	78	0.39	5.50	8.44	69
10	0.41	11.00	9.00	125	0.41	6.50	10.88	98
12	0.43	12.00	10.00	178	0.43	7.50	13.25	139

**COMPACT FLANGED FITTINGS
DUCTILE IRON
Pressure Rating 250 Psi
Manufacturer's Standard**

TEES

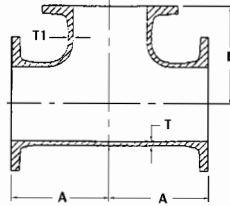

Flange x Flange Compact Tee

SIZE	FLANGE X FLANGE COMPACT TEE				
	DIMENSIONS IN INCHES				WT. (LBS.)
	T	T1	A	B	
4 X 3	0.35	0.34	6.50	6.50	38
4	0.35	0.35	6.50	6.50	41
6 X 4	0.37	0.35	8.00	8.00	68
6	0.37	0.37	8.00	8.00	75
8 X 4	0.39	0.35	9.00	9.00	83
8 X 6	0.39	0.37	9.00	9.00	90
8	0.39	0.39	9.00	9.00	105
10 X 6	0.41	0.37	11.00	11.00	145
10 X 8	0.41	0.39	11.00	11.00	152
10	.041	0.41	11.00	11.00	170
12 X 6	0.43	0.37	12.00	12.00	187
12 X 8	0.43	0.39	12.00	12.00	205
12	0.43	0.43	12.00	12.00	245

CROSSES

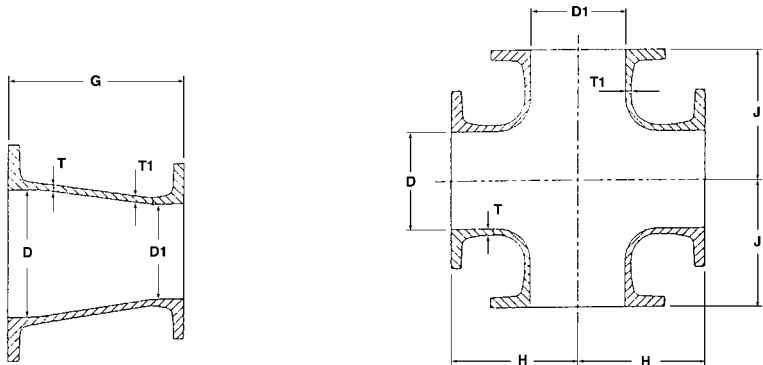

Flanged Compact Concentric Reducer

Flanged Compact Cross

FLANGED COMPACT CONCENTRIC REDUCER					FLANGED COMPACT CROSS					
D x D1	DIMENSIONS IN INCHES			WT. (LBS.)	D x D1	DIMENSIONS IN INCHES				WT. (LBS.)
	T	T1	G			T	T1	H	J	
6 X 4	.37	.35	9.0	41	8 X 8	.39	.39	9.0	9.0	138
8 X 6	.39	.37	11.0	54						

**CLOW THRUST-LOCK® FITTINGS
SPECS
ANSI/AWWA C110/A21.10**

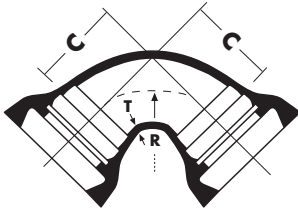

(90°) 1/4 Bend

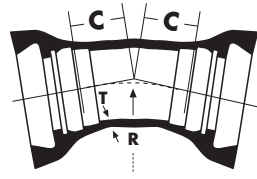

(22 1/2°) 1/16 Bend

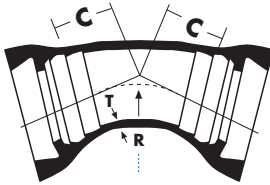

(45°) 1/8 Bend

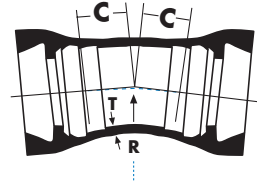

(11 1/4°) 1/32 Bend

SIZE	C	T	1/4 BEND (90°)			SIZE	C	T	1/8 BEND (45°)			1/16 BEND (22 1/2°)			1/32 BEND (11 1/4°)		
			R	WT. TL x TL	WT. TL x FE				R	WT. TL x TL	WT. TL x FE	R	WT. TL x TL	WT. TL x FE	R	WT. TL x TL	WT. TL x FE
6	8	.55	6	117	100	6	5	.55	7 1/4	102	84	15 1/16	102	84	30 1/2	102	84
8	9	.60	7	190	157	8	5 1/2	.60	8 7/16	152	123	17 5/8	152	123	35 1/2	152	123
10	11	.68	9	278	233	10	6 1/2	.68	10 7/8	241	208	22 5/8	241	208	45 11/16	241	208
12	12	.75	10	399	338	12	7 1/2	.75	13 1/4	313	276	27 5/8	313	276	55 13/16	313	276
14	14	.66	11 1/2	544	—	14	7 1/2	.66	12 1/16	446	364	25 1/8	446	364	50 3/4	446	364
16	15	.70	11 1/2	754	631	16	8	.70	13 1/4	617	530	27 5/8	617	530	55 13/16	617	530
18	16 1/2	.75	14	881	785	18	8 1/2	.75	14 1/2	752	610	30 3/16	752	610	60 15/16	752	610
20	18	.80	15 1/2	1088	939	20	9 1/2	.80	16 7/8	889	737	35 3/16	889	737	71 1/16	889	737
24	22	.89	18 1/2	1701	1443	24	11	.89	18 1/8	1360	1150	37 11/16	1360	1150	76 1/8	1360	1150
30	25	1.03	21 1/2	2484	—	30	15	1.03	27 3/4	2142	—	57 13/16	2030	—	116 3/4	2219	—
36	25	1.03	21 1/2	3150	—	30	15	1.03	27 3/4	3156	—	57 13/16	3166	—	116 3/4	3155	—

Rated working pressure is 350 psi for 6" - 24". Super-Lock® fittings (250 psi for 30").

**CLOW THRUST-LOCK® FITTINGS
SPECS
ANSI/AWWA C110/A21.10**

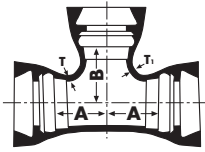

Tee

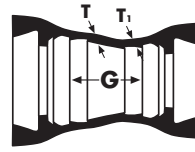

Reducer

SIZE RUN	BRANCH	A	B	T	T1	WEIGHT	
						ALL TL	TL x FE
6	6	8	8	.55	.55	171	150
8	6	9	9	.60	.55	226	221
8	8	9	9	.60	.60	263	226
10	6	11	11	.68	.55	346	334
10	8	11	11	.68	.60	400	370
10	10	11	11	.8	.80	429	372
12	6	12	12	.75	.55	435	441
12	8	12	12	.75	.60	473	446
12	10	12	12	.87	.80	514	476
12	12	12	12	.87	.87	569	532
14	6	14	14	.66	.55	647	657
14	8	14	14	.66	.60	695	707
14	10	14	14	.66	.68	715	732
14	12	14	14	.66	.75	732	724
14	14	14	14	.66	.66	816	710
16	6	15	15	.70	.55	845	817
16	8	15	15	.70	.60	881	890
16	10	15	15	.70	.68	—	936
16	12	15	15	.70	.75	913	880
16	14	15	15	.70	.66	—	952
16	16	15	15	.70	.70	1110	1154
18	6	13	15 1/2	.75	.55	1021	981
18	8	13	15 1/2	.75	.60	993	996
18	10	13	15 1/2	.75	.68	1099	1010
18	12	13	15 1/2	.75	.75	1120	1008
18	14	16 1/2	16 1/2	.75	.66	—	—
18	16	16 1/2	16 1/2	.75	.70	—	1230
18	18	16 1/2	16 1/2	.75	.75	1335	1436
20	6	14	17	.80	.55	—	—
20	8	14	17	.80	.60	—	—
20	10	14	17	.80	.68	—	—
20	12	14	17	.80	.75	—	—
20	14	14	17	.80	.66	—	—
20	16	18	18	.80	.70	—	—
20	18	18	18	.80	.75	—	—
20	20	18	18	.80	.80	1596	2421
24	6	15	19	.89	.55	—	1596
24	8	15	19	.89	.60	—	1578
24	10	15	19	.89	.68	1639	1626
24	12	15	19	.89	.75	—	1638
24	14	15	19	.89	.66	—	1676
24	16	15	19	.89	.70	—	1642
24	18	22	22	.89	.75	2257	—
24	20	22	22	.89	.80	2291	—
24	24	22	22	.89	.89	2533	—
30	6	18	23	1.03	.55	—	—
30	8	18	23	1.03	.60	—	—
30	30	25	25	1.03	1.03	3495	—
36	30	28	28	1.03	1.03	4540	—
36	36	28	28	1.03	1.03	—	—

SIZE	G	T	T1	WEIGHT	
				ALL TL	TL x FE
8 X 6	11	.60	.55	100	
10 X 6	12	.68	.55	120	
10 X 8	12	.68	.60	145	
12 X 6	14	.75	.55	155	
12 X 8	14	.75	.60	180	
12 X 10	14	.75	.68	200	
14 X 6	16	.66	.55	180	
14 X 8	16	.66	.60	205	
14 X 10	16	.66	.68	225	
14 X 12	16	.66	.75	250	
16 X 6	18	.70	.55	215	
16 X 8	18	.70	.60	245	
16 X 10	18	.70	.68	270	
16 X 12	18	.70	.75	300	
16 X 14	18	.70	.66	310	
18 X 8	19	.75	.60	290	
18 X 10	19	.75	.68	315	
18 X 12	19	.75	.75	345	
18 X 14	19	.75	.66	355	
18 X 16	19	.75	.70	385	
20 X 10	20	.80	.68	365	
20 X 12	20	.80	.75	395	
20 X 14	20	.80	.66	405	
20 X 16	20	.80	.70	440	
20 X 18	20	.80	.75	475	
24 X 12	24	.89	.75	535	
24 X 14	24	.89	.66	545	
24 X 16	24	.89	.70	580	
24 X 18	24	.89	.75	625	
24 X 20	24	.89	.80	670	
30 X 16	30	1.03	.70	860	
30 X 18	30	1.03	.75	910	
30 X 20	30	1.03	.80	965	
30 X 24	30	1.03	.89	1075	

**CLOW THRUST-LOCK® FITTINGS
SPECS
ANSI/AWWA C110/A21.10**

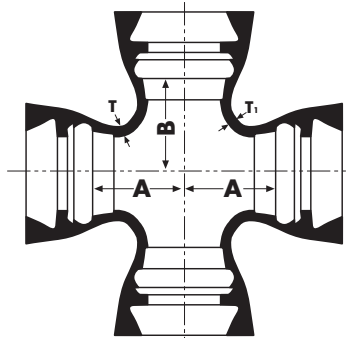

Cross

SIZE RUN	BRANCH	A	B	T	T1	WEIGHT ALL TL	WEIGHT TL X FE	SIZE RUN	BRANCH	A	B	T	T1	WEIGHT ALL TL	WEIGHT TL X FE
6	6	8	8	.55	.55	215	174	18	8	13	15 1/2	.75	.60	1092	—
8	6	9	9	.60	.55	286	248	18	10	13	15 1/2	.75	.68	1220	—
8	8	9	9	.60	.60	345	293	18	12	13	15 1/2	.75	.75	—	1206
10	6	11	11	.68	.55	411	381	18	14	16 1/2	16 1/2	.75	.66	—	—
10	8	11	11	.68	.60	462	418	18	16	16 1/2	16 1/2	.75	.70	—	—
10	10	11	11	.80	.80	537	—	20	6	—	—	.75	.75	—	—
12	6	12	12	.75	.55	523	488	20	8	—	—	.75	.75	—	—
12	8	12	12	.75	.60	584	510	20	10	14	17	.75	.75	1414	—
12	10	12	12	.87	.80	634	561	20	12	—	—	.80	.75	—	—
12	12	12	12	.87	.87	677	596	20	14	—	—	.80	.66	—	—
14	6	14	14	.66	.55	772	812	20	16	18	18	.80	.70	2000	—
14	8	14	14	.66	.60	833	—	20	18	—	—	.80	.75	—	—
14	10	14	14	.66	.68	853	797	20	20	—	—	.80	.80	—	—
14	12	14	14	.66	.75	963	—	24	6	—	—	.89	.55	—	—
14	14	14	14	.66	.66	1084	—	24	8	—	—	.89	.60	—	—
16	6	15	15	.70	.55	925	—	24	10	15	19	.89	.68	1670	—
16	8	15	15	.70	.60	965	944	24	12	—	—	.89	.75	—	—
16	10	15	15	.70	.68	1026	950	24	14	—	—	.89	.66	—	—
16	12	15	15	.70	.75	1036	1036	24	16	—	—	.89	.70	—	—
16	14	15	15	.70	.66	—	—	24	18	—	—	.89	.75	—	—
16	16	15	15	.70	.70	1408	—	24	20	—	—	.89	.80	—	—
18	6	13	15 1/2	.75	.55	1065	1082	24	24	22	22	.89	.89	3242	—

**CLOW THRUST-LOCK® FITTINGS
SPECS
ANSI/AWWA C110/A21.10**

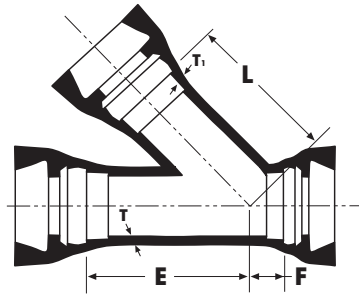

WYE Branch

SIZE RUN	BRANCH	L	E	F	T	T1	WEIGHT ALL TL	WEIGHT TL X FE
6	6	14.5	14.5	3.5	.55	.55	205	175
8	6	17.5	17.5	4.5	.60	.55	273	256
8	8	17.5	17.5	4.5	.60	.60	294	286
10	6	20.5	20.5	5.0	.68	.55	401	—
10	8	20.5	20.5	5.0	.68	.60	498	—
10	10	20.5	20.5	5.0	.68	.68	511	—
12	6	24.5	24.5	5.5	.75	.55	527	526
12	8	24.5	24.5	5.5	.75	.60	561	542
12	10	24.5	24.5	5.5	.75	.68	635	—
12	12	24.5	24.5	5.5	.75	.75	644	618

**DUCTILE IRON C110- FULL BODY
MECHANICAL JOINT FITTINGS
ANSI/AWWA C110/A21.10, ANSI/AWWA C111/A21.11**

90° BENDS (1/4)

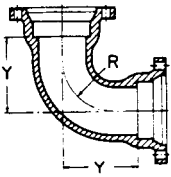

90° MJ x MJ (1/4)

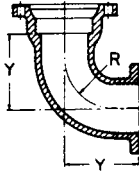

90° MJ x FE (1/4)

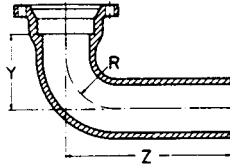

90° MJ x PE (1/4)

SIZE	DIMENSIONS			WEIGHTS		
	R	Y	Z	MJ x MJ	MJ x PE	MJ x FE*
*2	2.25	3.25	...	14
3	4.0	5.5	13.5	35	35	32
4	4.5	6.5	14.5	55	50	39
6	6.0	8.0	16.0	85	80	75
8	7.0	9.0	17.0	125	120	115
10	9.0	11.0	19.0	190	190	165
12	10.0	12.0	20.0	255	255	246
14	11.5	14.0	22.0	380	365	310
16	12.5	15.0	23.0	490	470	415
18	14.0	16.5	24.5	625	600	520
20	15.5	18.0	26.0	790	775	660
24	18.5	22.0	30.0	1215	1175	1150
30	21.5	25.0	33.0	2030	1585	...
36	24.5	28.0	36.0	2475	2310	...

*Not included in AWWA C110.

**CAST IRON SERVICE BOXES, ADJUSTABLE
6500 SERIES, SCREW TYPE**

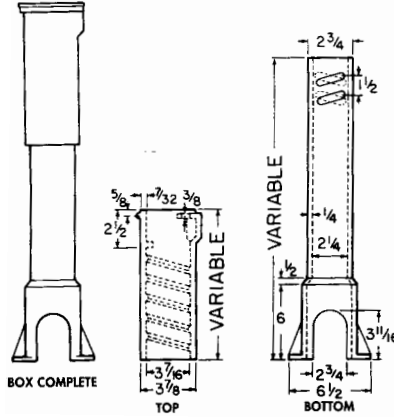

ITEM	BOX COMPLETE, EXTENSION IN INCHES	WEIGHT	TOP SECTION		EXTENSION			BOTTOM ONLY		*PIECES PER PKG.
			HEIGHT	WEIGHT	ITEM	HEIGHT	WEIGHT	HEIGHT	WEIGHT	
89-A	15-21	20	12	11	NOT REQUIRED			12	9	...
90-B	18-24	21	12	11	NOT REQUIRED			15	10	...
90-C	21-97	22	15	12	NOT REQUIRED			15	10	...
91-C	24-33	24	15	12	NOT REQUIRED			21	12	...
92-C	30-39	26	15	12	NOT REQUIRED			27	14	63
92-D	30-42	28	18	14	NOT REQUIRED			27	14	63
93-D	36-48	32	18	14	NOT REQUIRED			33	18	45
93-E	36-54	37	24	19	NOT REQUIRED			33	18	45
94-E	42-60	41	24	19	NOT REQUIRED			39	22	50
95-E	41-64	44	30	22	NOT REQUIRED			39	22	50
100-E	54-72	50	24	19	154	30	19	21	12	40
100-F	54-78	53	30	22	154	30	19	21	12	40
101-F	60-84	55	30	22	154	30	19	27	14	40

*Loose pieces may be shipped if packaging delays your order.

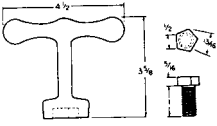

Wrench Brass Screw

WEIGHT	WEIGHT
1/2 LB.	...

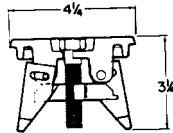

(New Style)
Repair Lid

ITEM	WEIGHT
6500	4.5



(Old Style) Repair Lid

ITEM	WEIGHT
6500	4.5

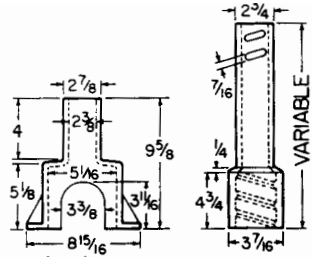

Enlarged Base

Extension

ITEM	Enlarged Base		ITEM	Extension	
	HEIGHT INCREASE	WEIGHT		HEIGHT INCREASE	WEIGHT
6500	6"	8	151	9	7
			152	16	12
			153	28	17
			154	30	19

Accommodates Through 1-1/4" Curbstops; Enlarged Base Accommodates Through 2" Curbstops
2-1/2 Inch Shaft

**7016-7026 TYLER TY-SPUN ADJUSTABLE VALVE BOX
COMPLETE WITH 5 1/4" LID**

Most Economical - Tyler's least expensive valve box - Made in USA - compares dollar for dollar with imported valve boxes.

Stronger - Centrifugal casting spins molten iron inside uniform metal molds to cast superior products with predictable, consistent, dimensionally uniform wall thickness. This process produces a box that has high resistance to breakage; no more broken pieces scattered around your storage yard.

Field-Adjustable - Unique roll-in O-ring stabilizes top unit and maintains grade location...yet will shift to adjust to extreme loads before damaging the valve.

Improved Design - No top flange to get in the way of surface finishing.

Accommodating - Conventional 5 1/4 inch drop lids, 5 1/4 inch locking lids and risers fit these valve boxes.

Packaging - Sold in quantities of twelve only.

DESCRIPTION	UPC #	SHIP CODE	SIZE	WEIGHT
7016	*376224	S	27" - 39"	66
7026	*376231	S	40" - 60"	99

* Assembly complete with top section, bottom section, O-Ring and lid.

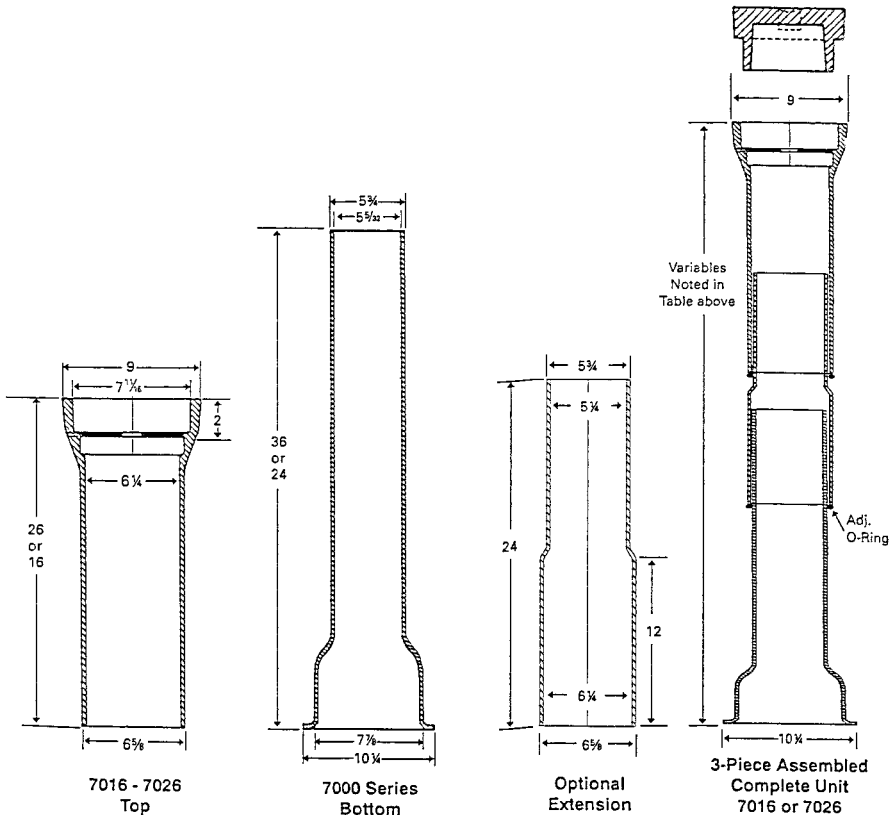

**7116-7126 WITH FLANGE
TYLER TY-SPUN ADJUSTABLE VALVE BOX
COMPLETE WITH 5 1/4" LID**

Stronger - Centrifugal casting spins molten iron inside metal molds to cast superior products with predictable, consistent dimensionally uniform wall thickness throughout.

Field-Adjustable - Unique roll-in O-ring stabilizes top unit and maintains grade location...yet will shift to adjust to extreme loads before damaging the valve.

Versatile - New design and technology obsoletes all old-fashioned styles, two-piece and three-piece, slip-type and screw-type.

Accommodating - Conventional 5 1/4 inch drop lids and risers fit these valve boxes.

DESCRIPTION	UPC # 670610	SHIP CODE	SIZE	WEIGHT
7116	*376781	S	27" - 39"	79
7126	*376798	S	40" - 60"	106

* Assembly complete with top section, bottom section, O-Ring and lid.

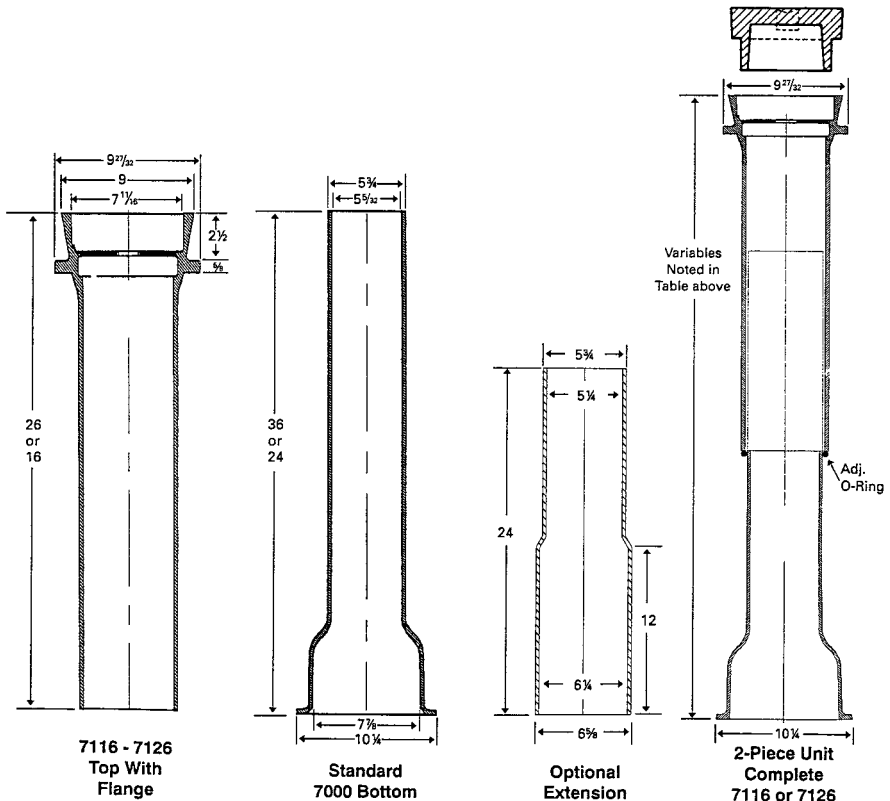

CAST IRON VALVE BOXES, TWO-PIECE
For 4" through 12" Valves
5-1/4" Shafts, Screw Type
6850 Series

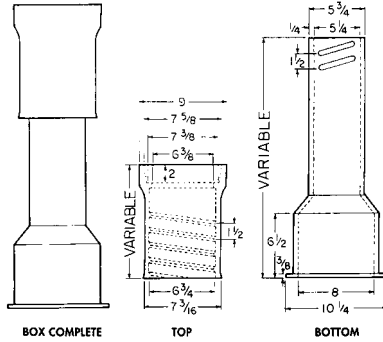

ITEM	BOX COMPLETE LESS LID EXTENSION IN INCHES	WEIGHT	5-1/4" DROP LID WEIGHT	TOP SECTION, LESS LID		BOTTOM		*PIECES PER PKG.
				LENGTH	WEIGHT	LENGTH	WEIGHT	
461-S	19-22	49	13	10	22	15	27	...
462-S	27-32	59	13	10	22	24	37	...
562-S	27-37	69	13	16	32	24	37	20
563-S	33-43	72	13	16	32	30	40	20
564-S	39-50	80	13	16	32	36	48	20
662-S	36-52	90	13	26	50	30	40	20
664-S	39-60	98	13	26	50	36	48	20
666-S	51-71	120	13	26	50	**48	70	20
668-S	62-82	135	13	26	50	**60	85	20

* Loose pieces may be shipped if packaging delays your order.

** May be furnished in two pieces screwed together to make the length required.

Lids Marked "WATER" will ship unless otherwise specified:
Also available 5-1/4 Drop Lids: GAS, SEWER, PLAIN

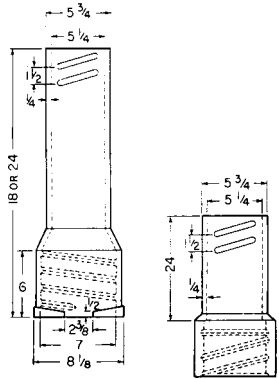

58 and 59 Extension 60 Extension

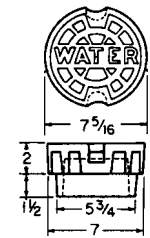

5-1/4 Drop Lid

WEIGHT
13

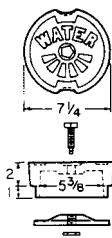

5-1/4 Lock Lid

WEIGHT
18

ITEM	HEIGHT INCREASE	WEIGHT	ITEM	HEIGHT INCREASE	WEIGHT
58	14	29	60	24	37
59	18	30			

#58, #59 and #60 Extensions also fit Series 6860 three-piece valve boxes.

CAST IRON VALVE BOXES, TWO-PIECE
For 4" through 12" Valves
5-1/4" Shafts, Slip Type
6855 Series

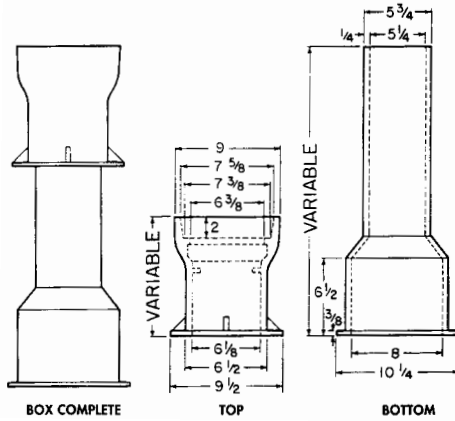

ITEM	BOX COMPLETE LESS LID EXTENSION IN INCHES	WEIGHT	5-1/4" DROP LID WEIGHT	TOP SECTION, LESS LID		BOTTOM		*PIECES PER PKG.
				LENGTH	WEIGHT	LENGTH	WEIGHT	
461-A	20-25	45	13	10	23	15	22	...
462-A	28-33	55	13	10	23	24	32	...
562-A	28-38	66	13	16	34	24	32	20
563-A	34-44	74	13	16	34	30	40	20
564-A	40-51	78	13	16	34	36	44	20
662-A	37-53	92	13	26	52	30	40	20
664-A	40-61	96	13	26	52	36	44	20
666-A	52-82	133	13	26	52	**48	69	20
668-A	63-83	161	13	26	52	**60	81	20

*Loose pieces may be shipped if packaging delays your order.

**May be furnished in two pieces screwed together to make the length required.

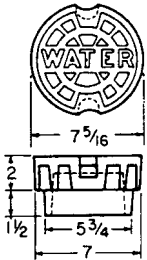

5-1/4 Drop Lid

WEIGHT
13

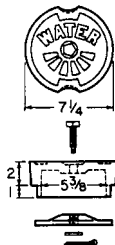

5-1/4 Lock Lid

WEIGHT
18

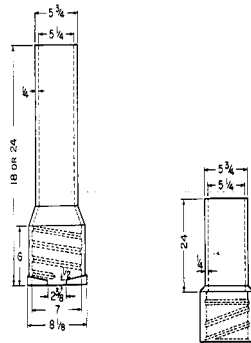

58-A and 59-A Extension 60-A Extension

ITEM	HEIGHT INCREASE	WEIGHT	ITEM	HEIGHT INCREASE	WEIGHT
58-A	14	29	60-A	24	37
59-A	18	30			

CAST IRON VALVE BOXES, THREE-PIECE
For 3" through 20" Valves
5-1/4" Shafts, Screw Type
6860 Series

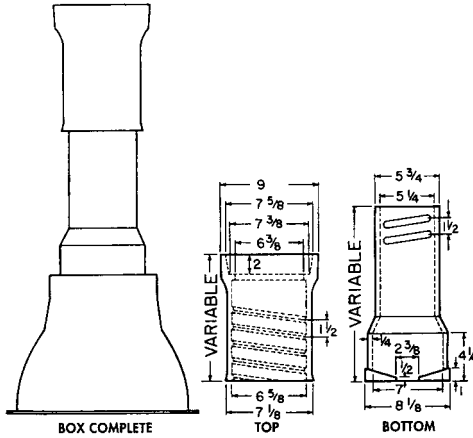

ITEM	ASSEMBLED BOX LESS BASE & LID EXTENSION IN INCHES	WEIGHT	5-1/4" DROP LID WEIGHT	TOP SECTION, LESS LID		BOTTOM		PIECES PER PKG.
				LENGTH	WEIGHT	LENGTH	WEIGHT	
AA	27-31	38	13	10	22	12	16	...
A	33-42	62	13	16	33	18	29	...
B	39-49	63	13	16	33	24	30	20
C	45-54	70	13	16	33	30	37	20
CC	51-60	74	13	16	33	36	41	20
D	45-66	87	13	26	50	30	37	20
DD	51-72	91	13	26	50	36	41	20
E	63-72	93	13	16	33	**48	60	20
F	63-84	110	13	26	50	**48	60	20
G	74-94	124	13	26	50	**60	74	20

**May be furnished in two pieces screwed together to make the length required.

#58, #59 and #60 Extensions shown on p. 87 also fit 6860 series valve boxes.

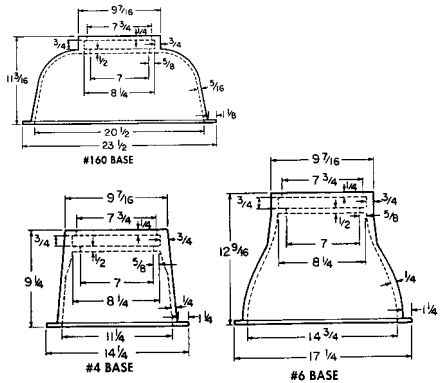

Bases for 6860 Valve Boxes

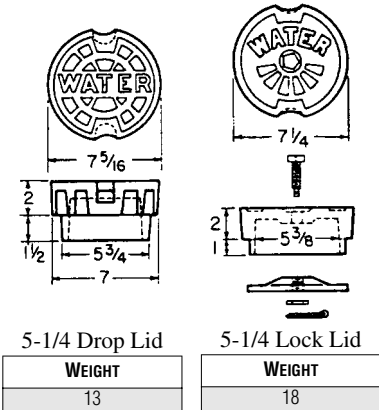

No.	INCREASE	WEIGHT
4	8	34
6	11.5	45
160	10	68

**FIXED AND ADJUSTABLE CAST IRON RISERS
FOR ALL 5-1/4" SHAFT VALVE BOXES
6850, 6855, 6860**

ADJUSTABLE RISERS

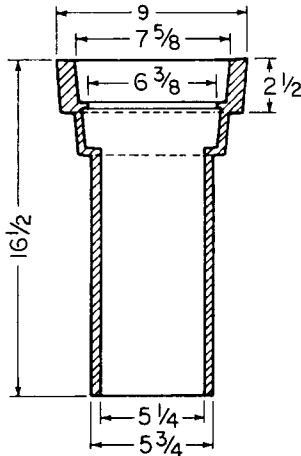

Slip Type Adjustable Risers
For 6855 Series

ITEM	HEIGHT INCREASE	WEIGHT
69-A	2-1/2-12	31

(Uses Standard Drop Lid)

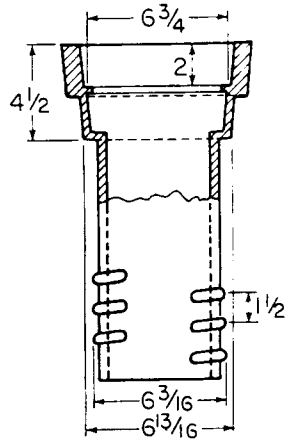

Screw Type Adjustable Risers
For 6850/60 Series

ITEM	HEIGHT INCREASE	WEIGHT
69	2-1/2-9	32

(Uses Standard Drop Lid)

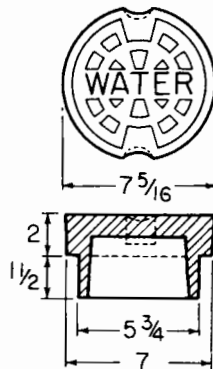

5-1/4" Standard Drop Lid

WEIGHT
13

Lids Marked "WATER" will ship unless otherwise specified:
Also available 5-1/4 Drop Lids: GAS, SEWER, PLAIN

FIXED CAST IRON RISERS FOR ALL 5-1/4" VALVE BOXES

FIXED RISERS

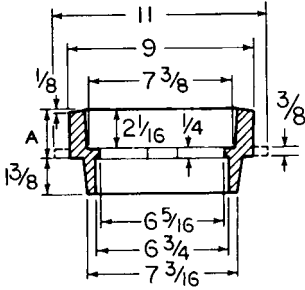

5-1/4" x 2-1/4" Riser

A	WEIGHT	WEIGHT w/SKIRT
2-1/4	14	16

(Uses Standard Drop Lid)

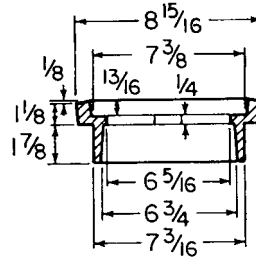

5-1/4" x 1-1/8" Risers

WEIGHT
9

(Uses 5-1/4" x 1-1/8" Lid)

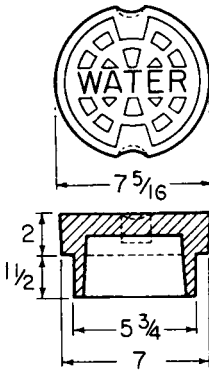

5-1/4" Standard Drop Lid

WEIGHT
13

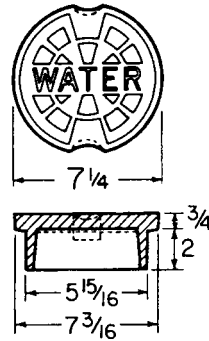

5-1/4" x 1-1/8" Lid

WEIGHT
11

METER COVER, CAST IRON

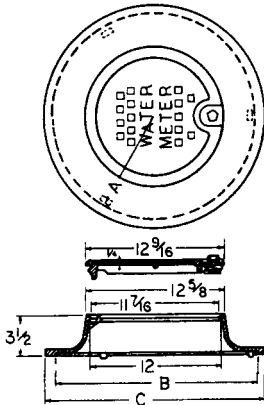

6150 Meter Box Cover

ITEM	A	B	C	WEIGHT
6150-R-20 RING ONLY	9-3/4	20	22	30
6150-R-18 RING ONLY	8-3/4	18	20	28
6150-20 RING & Lid B/L*				41
6150-18 RING & Lid B/L*				39
6150-18/20 Lid w/LOCK B/L*				11
6150-20 RING & Lid B/S*				41
6150-18 RING & Lid B/S*				39
6150-18/20 Lid w/LOCK B/S*				11
6150-L-18/20 Lid LESS LOCK				10

* B/L = Large Bolts

* B/S = Small Bolts

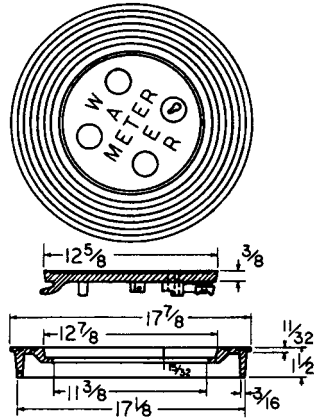

6200 Meter Cover

ITEM	WEIGHT
6200 METER RING & Lid LESS LOCK	28
6200-R METER RING ONLY	17
6200-L METER Lid w/G	11
6200-L METER Lid LESS LOCK	11

TOUCH-READER (TR) RINGS & LIDS

6150 TR Meter Cover

ITEM	WEIGHT
6150-20 RING & Lid, TR, B/L*	41
6150-18 RING & Lid, TR, B/L*	39
6150-20 RING & Lid, TR, B/S*	41
6150-18 RING & Lid, TR, B/S*	39
6150-18/20 Lid w/LOCK, TR, B/L*	11
6150-18/20 Lid w/LOCK, TR, B/S*	11
6150-18/20 Lid LESS LOCK, TR	11

* B/L = Large Bolts

* B/S = Small Bolts

NOTE: 6150TR has same dimensions as 6150; with 1-3/4" access hole in lid.

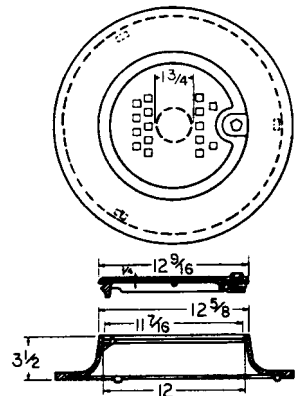

DUCTILE IRON MECHANICAL JOINT RETAINER GLANDS MANUFACTURER'S STANDARD

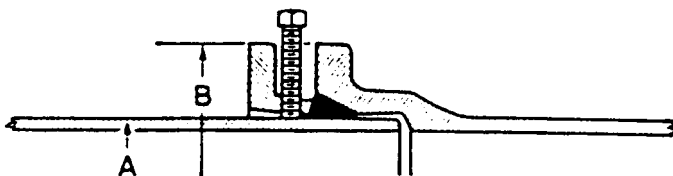

Mechanical Joint Retainer Glands are designed to provide a method for additional restraining of mechanical joint pipe and fittings and other standardized mechanical joints against possible joint separation, rupture or blow-out caused by internal water pressures.

The set screws are square-head with Type C knurled cup points, and are shipped already assembled in the Glands. They are manufactured of 4140 grade alloy steel, and are heat treated to Rockwell "C" 45/53 core hardness. Tee-head bolts and gaskets are not included, but may be ordered separately. Recommended torque for set screws is 75 foot pounds, and set screws on opposite sides of the glands should be tightened alternately.

Tee-head bolt hole size and spacing are equal to MJ Glands as shown in AWWA C111. Standard Mechanical Joint gaskets as shown in C111 should be used. Detailed installation instructions are available.

SIZE	PRESSURE RATING PSI	DIMENSIONS		NO. OF SET SCREWS	SIZE OF SET SCREWS	WEIGHT POUNDS
		GLAND O.D. B	PIPE O.D. A			
3	350	7.69	3.96	4	5/8 X 2	4
4	350	9.12	4.80	4	5/8 X 2	5
6	350	11.12	6.90	6	5/8 X 2	9
8	250	13.37	9.05	9	5/8 X 2	13
10	250	15.62	11.10	12	5/8 X 2	17
12	150	17.88	13.20	16	5/8 X 2	20
*14	250	20.25	15.30	20	5/8 X 2-1/2	45
*16	200	22.50	17.40	24	5/8 X 2-1/2	46
*18	200	24.75	19.50	24	5/8 X 2-1/2	62
*20	200	27.00	21.60	28	5/8 X 3	75
*24	150	31.50	25.80	32	5/8 X 3	85

*Sizes 14" and larger are not recommended for use on pipe thinner than thickness class 53.

DUCTILE IRON MJ TAPPING SLEEVES

SAMPLE SPECIFICATION

Ductile Iron Mechanical Joint Tapping Sleeves manufactured by Tyler Pipe are produced in accordance with Manufacturer's Standards. Chemical and physical properties of the ductile iron are in accordance with the requirements of ANSI/AWWA C110/A21.10-82.

Recess dimensions are per Manufacturer's Standardization Society standard practice SP-60.

General Installation Instructions for Tyler MJ Tapping Sleeves:

1. Clean pipe - insert side gasket into back half of gasket grooves. Make sure ends are flush with or slightly protrude into the end gasket seating area.
2. Bolt sleeve halves together and trim side gaskets as necessary. **MAKE SURE SLEEVE WILL ROTATE FREELY ON PIPE.**
3. Install ends gaskets, locating cut ends 90° from side gasket. If pipe is maximum OD, stretch gasket to make certain cut ends match with no gap in between.
4. Install glands and bolts - rotate sleeve to desired position. Be sure pipe is centered inside the sleeve.
5. Tighten gland bolts alternately, using 80 to 90 foot pounds.
6. After assembly, **PRESSURE TEST ALL JOINTS BEFORE TAPPING.** If additional tightening is required, release pressure and relax tension on gland bolts before tightening side bolts.

For Cast Iron or Ductile Iron Pipe

Mechanical joint tapping sleeves - for 6" through 12" cast iron or ductile iron pipe.

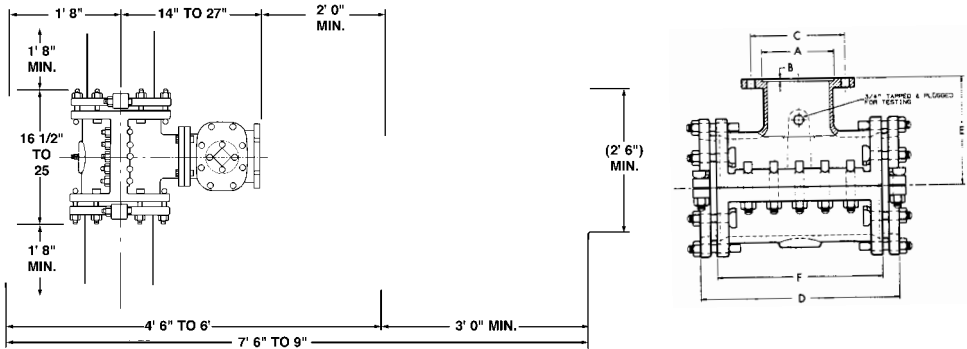

- Outlet flange per ANSI/AWWA C110/A21.10
- Gaskets furnished with armor -tip ends
- Working pressure—200 p.s.i.

TAPPING SLEEVE FOR CAST IRON/DUCTILE IRON

SIZE	DIMENSIONS						O.D. RANGE DI		WEIGHT DI
	A	B	C	D	E	F	MIN.	MAX.	
6 X 4	5.016	.250	7.50	17	9.00	14.00	6.85	7.15	220
6	7.016	.312	9.50	17	9.00	14.00	6.85	7.15	225
8 X 4	5.016	.250	7.50	19	10.50	16.00	9.00	9.35	275
8 X 6	7.016	.312	9.50	19	10.50	16.00	9.00	9.35	280
8	9.016	.312	11.75	19	10.50	16.00	9.00	9.35	295
10 X 4	5.016	.250	7.50	19	11.00	15.00	11.04	11.45	388
10 X 6	7.016	.312	9.50	19	11.00	15.00	11.04	11.45	392
10 X 8	9.016	.312	11.75	23	11.00	19.00	11.04	11.45	455
10	11.016	.312	14.25	23	11.00	19.00	11.04	11.45	470
12 X 4	5.016	.250	7.50	20	12.00	16.00	13.14	13.56	469
12 X 6	7.016	.312	9.50	20	12.00	16.00	13.14	13.56	471
12 X 8	9.016	.312	11.75	20	12.00	16.00	13.14	13.56	482
12 X 10	11.016	.312	14.25	26	12.00	22.00	13.14	13.56	595
12	13.016	.312	17.00	26	12.00	22.00	13.14	13.56	605

SECTION II. FITTINGS INDEX

A

Adapter:	
Adapter Flange	64
FE x PE (Flange End x Plain End)	46
MJ x FE (MJ x Flange End)	46, 55
Swivel (Swivel x Swivel and Swivel x Solid)	44, 59
UT x FE (Union-tite x Flange End)	76
Adjustable Valve Box Risers	91
Applicable Standards for Fittings (ANSI/AWWA Standards)	223
Assembly Instructions:	
MJ Tapping Sleeves	95

B

Base Bends, Flange	66-67
Base Tees, Flange	66
Base:	
Service Box 6500	85
Valve Box 6860	90
Bends, Clow Super Lock	78
Bends, Flange:	
AWWA C110	62, 66, 68
Compact	83
Bends, Mechanical Joint:	
AWWA C110 Full Body	51-52
AWWA C153 SSB/Compact	41-42
Bends, Swivel x Swivel Hydrant	47, 59
Bends, Union-tite Push-On	71, 72
Blind Flange	67
Bosses in Flanged Fittings	69

C

Caps:	
MJ C110 Full Body	60
MJ C153 SB/Compact	46
Union-tite C153	77
Cement Lining, Sample Specifications	41, 50, 70, 82
Compact/SSB Ductile Iron Fittings:	
Mechanical Joint	41-48
Flange	83-84
Union-tite Push-On	70-77
Companion Flanges (Threaded Flanges)	67
Concentric Reducers, Flange	65, 84
Covers, Meter	93
Crosses:	
Clow Super-Lock®	80
MJ C110 Full Body	56
MJ C153 SSB/Compact	43
Union-tite Push-On	77
Cutting-in Sleeves:	
MJ x FE Dual Purpose	47
MJ x PE Dual Purpose	58

D

Drop Lids, Valve Box	90, 91
Dual Purpose Cutting-in Sleeves	47, 58
Dual Purpose Solid Sleeves	58

E

Eccentric Reducers, Flange	65
Elbows: (See Bends)	
Extensions:	
Service Box	85
Valve Box	86-88

F

Fittings, Flange Ductile Iron:	
Compact	83-84
C110	62-69
Fittings, Mechanical Joint C110 Full Body Ductile Iron	50-61
Fittings, SSB/Compact C153 Ductile Iron:	
Mechanical Joint	41-48
Union-tite	70-77
Fittings, Specialty Plugs	49
Fixed Valve Box Risers	92
Flange Adapter	64
Flange x Mechanical Joint (MJ) Adapter	46, 55
Flange x Plain-end (PE) Adapter	46
Flange x Union-tite (UT) Adapter	76
Flange and Flare Fittings	68
Flange Bends	62, 66-68, 83
Flange Crosses	63-64, 84
Flange Drilling Template	62, 83
Flange Outlet Dimensions SSB/Compact	48
Flange Reducers	65, 84
Flanged Reducing Base Bends	67
Flange Side Outlet 90-Degree Bend	66
Flange Sludge Shoes	68
Flange Tap Location	69
Flange Tees:	
Base Tees	66
Bullhead Tees	63
Compact	84
MJxMJxFE	43-44, 53-54
UTxUTxFE	73-74
Reducing Tees	63-64
Straight Tees	63-64, 84
Flange True Wyes	68
Flange Wyes	66
Flanges:	
Adapter	64
Blind	67
Companion (Threaded)	67
Flare Pieces	68

G

Gas Lids, 5 1/4 Valve Box	87
Glands:	
Mechanical Joint Glands	60
Mechanical Joint Retainer	94
Split Repair	58

Swivel	44, 47, 59
H	
Hydrant Fittings:	
Adapters	44, 59
Ells (90-Degree Bends)	47, 59
Tees, MJ x Swivel	43-44, 59
Tees, Parallel	59
Tees, UT x Flange	73-74
Tees, UT x Swivel	73-74
L	
Lids:	
Service Box	85
Valve Box	88-91
Long Radius Bends, Flange	66
M	
McWane, Inc. Division Offices	i
Mechanical Joint:	
C110 Full Body	50-61
C153 Compact/SSB	41-48
Retainer Glands	53
Tapping Sleeves	54
Meter Covers	93
O	
Offsets, MJ	60
P	
Parallel Tees	59
Plain-end Dimensions	48, 61
Plain Lids, 5 1/4 Valve Box	88
Plugs:	
MJ C110 Full Body	60
MJ C153 SSB/Compact	46
Push-in Plug	49
Push-on Fittings (Union-tite)	70-77
R	
Ransom Industries, Inc. Division Offices	i
Reducers:	
Clow Super-Lock®	79
MJ SSB/Compact	45
MJ Full Body	57
Flange Compact	84
Flange C110	65
Union-tite	75
Tap Locations	69
Reducing Base Bends, Flange	67
Reducing Bends, Flange	66
Reducing Flanges	67
Reducing Tees:	
Clow Super-Lock®	79
MJ SSB/Compact	43-44
MJ Full Body	53-54
Flange Compact	84

Flange C110	63-64
Union-tite	73-74
Tap Locations	69
Repair Lid, Service Box	85
Repair Sleeve, MJ Split	58
Restrained Joint Fittings	78-81
Restrained Plug	49
Retainer Glands, MJ	94
Rings, Meter Box	93
Risers, Valve Box	91-92

S

Screw Type Valve Boxes:	
6850 Series, Two-Piece	88
6860 Series, Three-Piece	90
Service Boxes, 6500 Series	85
Sewer Lids, 5 1/4 Valve Box	88
Side Outlet 90-Degree Bend, Flange	66
Slip Type Valve Boxes:	
6855 Series, Two-Piece	89
7026 Series, Adjustable	86
7126 Series, Adjustable	87
Sleeves:	
Dual Purpose Cutting-in	47, 58
MJ Solid	46, 58
Split Repair	58
Tapping	95
Sludge Shoe, Flange	68
Solid Plugs and Caps, MJ	46, 60
Solid Sleeves, MJ	46, 58
Specialty Plugs	49
Split Repair Sleeve	58
SSB/Compact MJ Fittings	41-48
Super-Lock Fittings, Clow	78-81
Swivel x Solid Adapter	44, 59
Swivel x Swivel Adapter	59
Swivel & Swivel 90-Degree E11 (Bend)	59

T

Tap Locations, Flange Fittings	69
Tap Sizes, Maximum - Flange Fittings	69
Tapped Plugs and Caps:	
MJ SSB/Compact	46
MJ C110 Full Body	60
Union-tite	77
Tapping Sleeves	95
Tapped Tees/Crosses	46, 56
Tees:	
Base Tees, Flange	66
Clow Super-Lock [®]	79
Flange Compact	84
Flange C 110	63, 64
MJ SSB/Compact	43-44
MJ C110 Full Body	53-54
MJ x MJ x Swivel (Hydrant)	43-44, 59
Parallel MJ (Hydrant)	59
Union-tite	73-74

Template for Drilling, Flange	62, 83
Terms	ii
Threaded Flanges	67
Touch-Reader (TR) Rings & Lids	93
True Wye, Flange	68
Typical Installation, Cutting-in Sleeve	47

U

Union-tite Push-on Fittings	70-77
-----------------------------	-------

V

Valve Boxes:	
5 1/4" x 1 1/8" Lid	92
6850 Series Screw Type, 5 1/4"	88
6855 Series Slip Type, 5 1/4"	89
6860 Series Screw Type, 5 1/4"	90
7026 Series Adjustable, 5 1/4"	86
7126 Series, Adjustable, 5 1/4"	87
Adjustable Risers, 5 1/4"	91
Fixed Risers	92
Standard Drop Lid, 5 1/4"	91

W

Warranty	ii
Water Lids, Service Box 4 1/4", 6500 Series	85
Water Lids, Valve Box 5 1/4"	88-92
Wyes:	
Clow Super-Lock®	81
Flange C110 (45-Degree Lateral)	66
Flange C110 True Wye	68
MJ SSB/Compact C153	45
MJ C110 Full Body	55
Union-tite Push-On	76
Wrench, Service Box 6500 Series	85

Y

Y Brances (See Wyes)	
----------------------	--

This page intentionally left blank.

PIPE
ECONOMY

FIRE HYDRANTS

CLOW VALVE COMPANY

KENNEDY VALVE COMPANY

M & H VALVE COMPANY

This page intentionally left blank.

PIPE
ECONOMY

CONTENTS

History and Evolution of Fire Hydrants	113
Guardian Fire Hydrants	114
M & H Compression-Type	120
Medallion Compression-Type	126
Clow Compression-Type	128
Eddy Compression-Type	130
Wet Barrel Fire Hydrants	136
Ordering Information	137
Underwriters and Factory Mutual Fire Hydrants	138
Hose Coupling Thread Specifications	139
Installation, Operation and Maintenance Data	140
Index	143

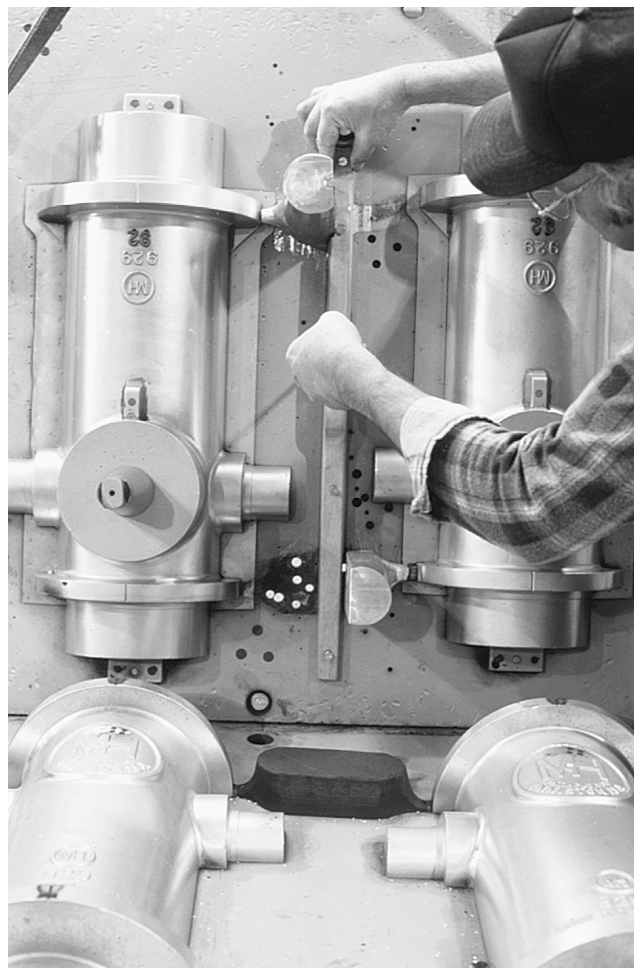

This page intentionally left blank.

PIPE
ECONOMY

HISTORY AND EVOLUTION OF FIRE HYDRANTS

Since the beginning of time, man has needed to control that phenomenon known as fire. If allowed to rage out of control, a fire can be one of the most destructive forces known. Various methods to combat and control fires have been employed over the years, but it is not until relatively recent time that the fire hydrant as we know it has been developed.

Key to controlling and extinguishing a fire is prompt action. This truth was known in early times when manual means were used to bring water to a fire. Bucket brigades were sometimes an effective means of controlling fires but the shortcomings of throwing water by hand from some convenient vessel soon became apparent.

As man moved towards urbanization, efforts were directed to the development of a more effective method that would increase both the range and volume of water that could be brought to play in combating a fire. The “syringe” and “siphon” were early developments that ultimately gave way to pumps which drew water from some nearby body of water.

With the introduction of buried, lowhead water distribution systems using bored out logs, the benefit of a ready source of water for fighting fires was quickly recognized. Early attempts to access this water were crude indeed. The street over the main was excavated and then a hole was bored in the main. Water would fill the excavation creating a cistern from which it could be drawn by bucket or suction hose from a pump. When the fire was extinguished, a wooden plug was driven into the main, the location noted, the excavation filled and the street repaired. This was a primitive procedure at best, but it did give us a term that survives to this day: “fireplug.”

As stronger cast iron replaced the wooden mains, the fire plug system made rapid advancements. First came a cast iron outlet in the main with a wooden plug and a cast iron shield to the surface. This gave way to a more effective cast iron standpipe inserted into the main with a hose connection at or above grade. This system, while a vast improvement over the wooden fire plug system, was short lived as pressure in the mains was steadily increased.

Advancements in pipe, joints, valving and pumps paved the way for higher service pressure which in turn led to the development of the fixed post fire hydrant with a control valve similar in concept to the dry barrel hydrants produced today. Although the origin of the term “fire hydrant” is obscure, it is a matter of record that the first practical hydrants were designed and installed by the Philadelphia Water Works early in the nineteenth century.

The McWane Companies offer the broadest range of hydrant models in the industry today. The very finest design, materials and workmanship are combined in these hydrants to provide unequaled fire protection.



**GUARDIAN COMPRESSION-TYPE FIRE HYDRANT
AWWA C502 STANDARD
UL/FM APPROVED**

The Kennedy GUARDIAN Fire Hydrant is the result of more than 100 years of experience producing well designed, premium fire hydrants for municipal and industrial use. The GUARDIANS design provides unequalled fire-fighting capability and high quality while maintaining the important Kennedy benefits of being simple to maintain and repair.

A specially designed thermoplastic thrust washer located at the solid bronze operating stem nut and the sealed grease cavity combine to provide smooth, easy operation. Re-lubrication of the operating threads is easily accomplished by the means of an Alemite fitting located in the operating nut. The cast iron weather shield protects the operating stem nut from possible dirt and corrosion build-up.

The unitized, one piece hydrant cap and stuffing box, utilizes O-ring seals to prevent the migration of water into the grease cavity.

With a solid bronze main valve seat threaded into a solid bronze insert in the hydrant shoe, removal of the main valve for inspection is easily accomplished. The main valve itself is made of tough, long wearing synthetic rubber that is steel reinforced.

A unique, pressure activated drain valve automatically drains the hydrant after use and prevents water from escaping while the hydrant is in use. The bronze drain is faced with long wearing synthetic rubber and connects to solid brass drainways insuring long, corrosion free life.

THE KENNEDY GUARDIAN

Fire hydrants have been used in fire protection for over 100 years. A.W.W.A. C502 was developed in 1913 as a standard for the manufacture and use of dry barrel hydrants. Kennedy has established itself as a leader in the industry with manufacturing experience dating back to 1905. Many of the early hydrants are in use today.

Kennedy's most recent design is the Guardian. Based on a simple design, it is easy to install, maintain and repair. The Guardian sets a standard for quality in the industry and meets or exceeds all requirements for A.W.W.A. C502 latest revision, and is UL listed and FM approved.

GUARDIAN FEATURES

K81D Meets or exceeds requirements of A.W.W.A. C502 and is UL listed and FM approved.

Easy to install - Even easier to maintain

- Tamper resistant quarter turn hose and steamer nozzles. For those who know how, replacement is easy.

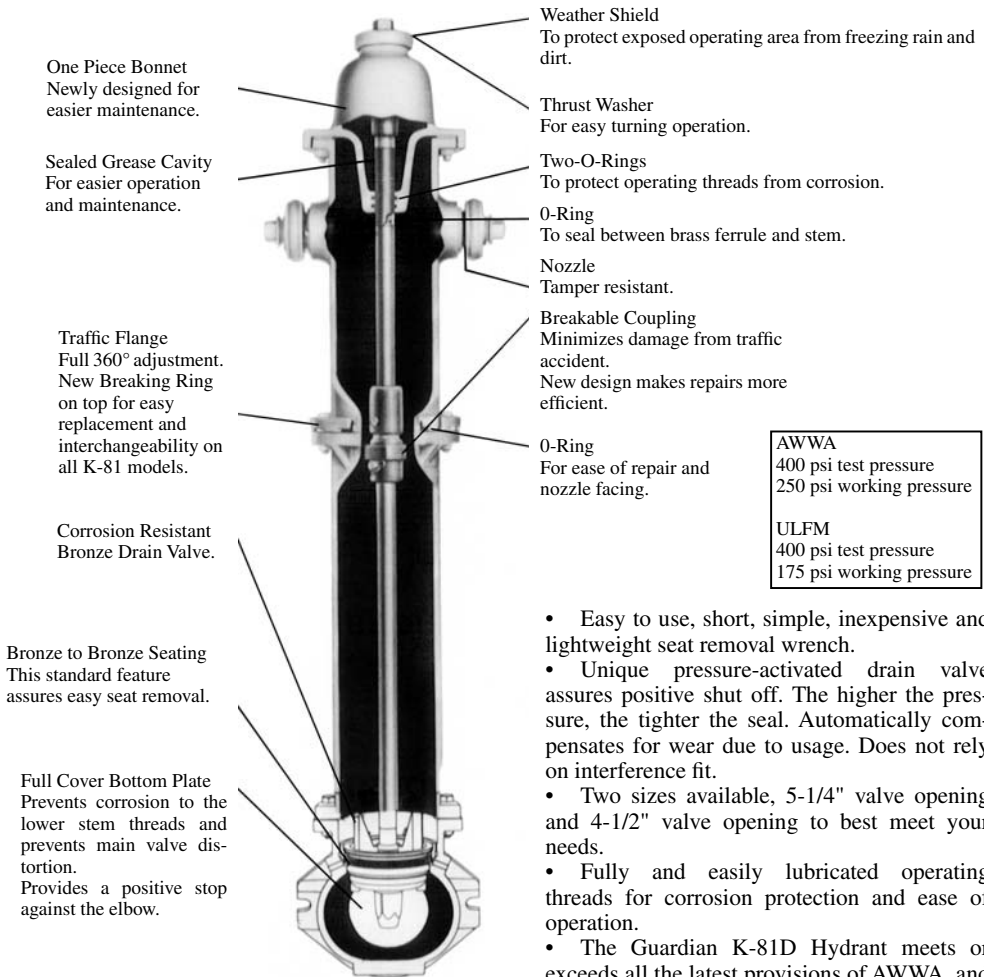
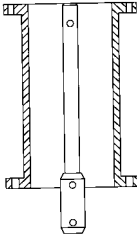

Fig. K81D

GUARDIAN K81D TECHNICAL/DIMENSIONAL DATA

Accessories



Extension Kit K8150

STYLE	SHOE SIZE
M.J.	4
M.J.	6
FLANGE	4
FLANGE	6
BELL	6
TYTON	6

Bell and Tyton ends available only in 5-1/4" Main Valve Hydrants.
4" shoe dimensions apply to 4-1/2" Main Valve Hydrants only.

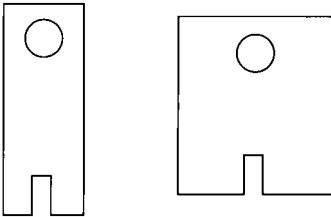

Nozzle Removing tools K8148

MARKINGS	
FRONT	BACK
YEAR	K.V. MONOGRAM
KENNEDY	KENNEDY
ELMIRA, N.Y.	ELMIRA, N.Y.
SIZE	SIZE
TYPE	UL/FM/AWWA
250CWP	175

Contact Factory for UL/FM Limitations

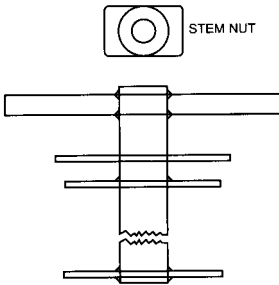

Seat Removing Wrench K8147

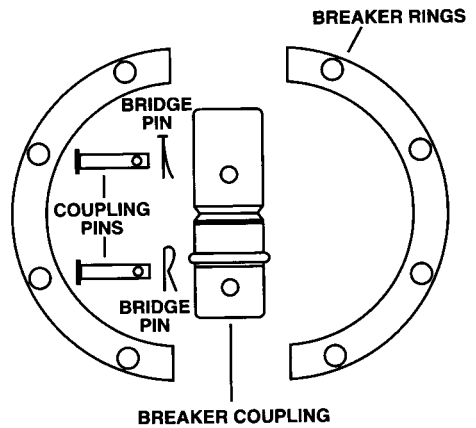

Collision Repair Kit K8149 (Includes pins and seals)

GUARDIAN INSERT

For users of WOOD-MATHEWS HYDRANTS

A True Guardian Insert Replacement

Save the cost of digging to replace that tried and true, but aging friend. Merely unscrew Mathews insert and replace it with a Guardian Insert, and for normal maintenance, never do it again. Check these benefits:

1. All working parts are Guardian.
2. Fully maintainable through the bonnet, using light weight wrench.
3. Available to replace all sizes and models of Wood-Mathews.

Additional Parts for Guardian Insert

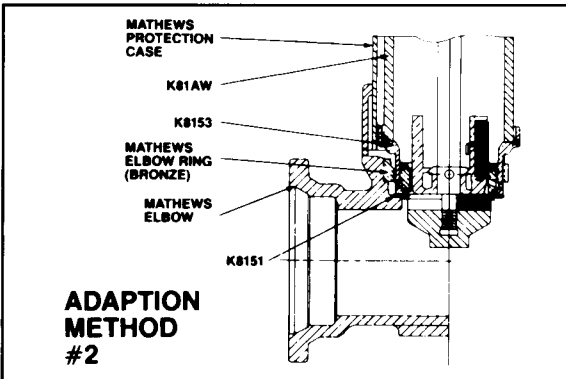
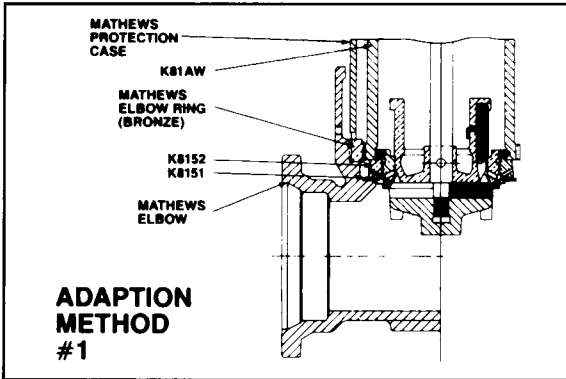

Adaption Method Chart (Corresponds to above illustrations)

K-81AW

M. V. O.		5-1/4"	4-1/2"	4"
6"	BRONZE LINED	1	-	-
6"	REGULAR	1	-	-
5-1/4"	BRONZE LINED	1	-	-
5-1/4"	REGULAR	2	-	-
4-1/2"	BRONZE LINED	-	1	-
4-1/2"	REGULAR	-	2	-
4"	REGULAR	-	-	2



Fig. K81AW

ORDERING INFORMATION

Guardian Hydrant

When ordering, indicate the following:

1. Size of main valve opening.
2. Quantity and threading details of hose nozzles.
3. Threading details of steamer nozzle.
4. Size and type of inlet connection (mechanical joint, flanged, bell, or tyton).
5. Depth of trench (from bottom of pipe to ground line).

Estimated Weights

		DEPTH OF TRENCH										
MAIN VALVE OPENING	K-81D	4-1/2"	2'6"	3'0"	3'6"	4'0"	4'6"	5'0"	5'6"	6'0"	6'6"	7'0"
				336	351	366	381	396	411	426	441	456
		5-1/4"	380	409	427	444	460	480	502	523	542	560
		3-WAY CONFIGURATION WITH M.J. SHOE LESS ACCESSORIES										
	K-81AW	4"	281	297	316	333	350	365	381	396	414	429
		4-1/2"	278	295	313	330	347	362	378	393	411	426
		5-1/4"	328	335	355	375	395	415	430	445	468	489
		3-WAY CONFIGURATION										

When ordering parts, indicate the following:

1. Part number.
2. Part description.
3. Type of hydrant.
4. Size of main valve opening.
5. Color (National standard yellow will be furnished unless otherwise indicated).
6. Size and shape of operating nut.
7. Direction to open.
8. Regular or Bronze Lined (for Mathews-Guardian Insert only).

ELBOW - We must have the size and type of connection to main.

OPERATING STEM NUT - Give direction to open (cast on cap) and size and shape of operating nut. 4-sided nut, give flat to flat dimension. 5-sided nut, give point to opposite flat dimension. 6-sided nut, give flat to flat dimension to eliminate any doubt as to where the measurement was taken.

Note: Dual rated hydrants are UL/FM approved for 1-1/2P and 1-1/4" sq. nut sizes.

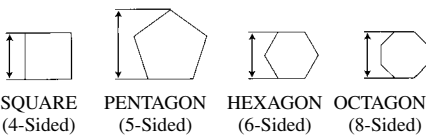

SQUARE (4-Sided) PENTAGON (5-Sided) HEXAGON (6-Sided) OCTAGON (8-Sided)

BONNET - Give direction the hydrant opens. This is indicated by an arrow cast on the cap. Indicate the direction the arrow points.

NOZZLE CAP GASKET - Indicate the size of nozzle and whether hose or steamer.

NOZZLE - Give exact threading details, outside (major) diameter, pitch diameter, root (minor) diameter and exact number of threads per inch (TPI) or send in a gauge or sample in good condition.

NOZZLE CAP CHAIN - Tell us the nozzle type, hose or steamer.

NOZZLE CAP - Exact threading and nut size and shape.

NOZZLE - Furnish all information cast on the barrel and the number of hose and steamer connections.

STEM - Furnish the direction the hydrant opens as cast on the bonnet and furnish the depth of trench (distance from groundline to bottom of connecting pipe). If the stem can be measured, complete overall dimensions including diameter will help. The diameter should always be measured on the smooth (unthreaded) portion.

STAND PIPE - Furnish depth of trench (distance from groundline to bottom of connecting pipe) or dimension from flange face (overall). The outside and inside diameters are also a help.

SEAT RING - As with all parts you order we must have size of main valve opening and type of hydrant. This is cast on the upper barrel.

5-1/4" K81AM AWWA GUARDIAN MONITOR HYDRANT

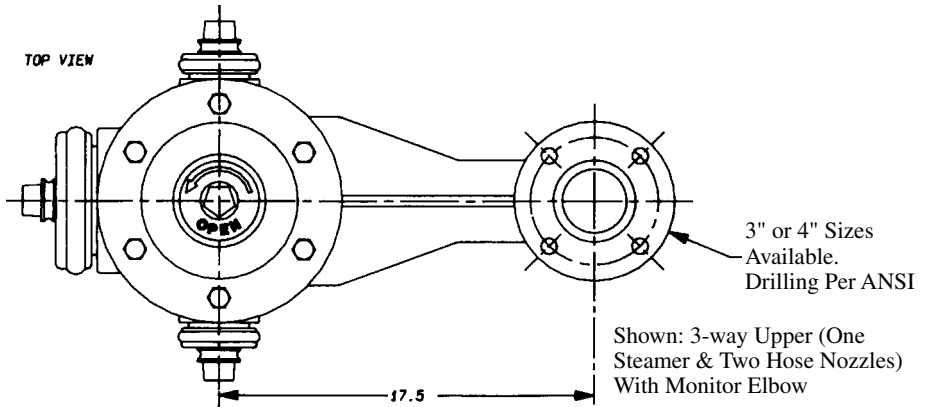

Options:

Upper Barrel Configurations

- 1 Steamer & 2 Hose Nozzles
- 2 Hose Nozzles
- 2 Steamer Nozzles
- 1 Steamer & 3 Hose Nozzles

Handwheel Operation - 16"

Inlet Connections

- 6" Mechanical Joint, Flanged, Push-on
- 8" Mechanical Joint or Flanged Elbow

2-1/2" Size

Independent Hose Gate Valves

- Bolt-on/Figure 109XNS
- Screw-on/Figure 109XMN

Operating Details

- "Open" Clockwise or Counter Clockwise
- Any Size & Shape of Operating Nuts
- Any Nozzle Outlet Thread(s)



THE M&H 129 FIRE HYDRANT

Yesterday, Today & Tomorrow

For over 60 years the M&H 129 hydrant has been produced to protect property and lives.

Hydrants produced in the 1930's are still able to be retrofitted with production parts built today.

Now, every modern hydrant feature is available on the 129 and we still can retrofit to existing hydrants.

M&H has kept the user in mind--continuously upgrading, while maintaining parts interchangeability, minimizing inventory and maximizing service life.

For the integrity of your system, specify M&H 129 fire hydrants with the assurance that our past reliability will continue into the future...all compatible.

Further evidence of the 129 unquestionable superiority is attested by its 5 year limited warranty protection on materials and workmanship.

Features and Benefits

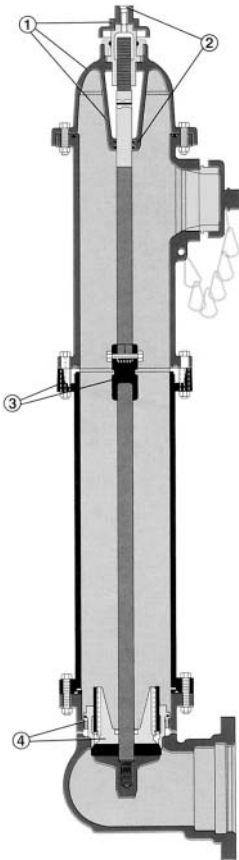

1. BONNET DESIGN is a single unit component with integral lubrication chamber completely isolating stem threads from any dirt or moisture. The one-piece operating nut/weathershield discourages tampering and repels outside weather elements that cause operating problems. A nylon thrust bearing maintains low operating torque effectively throughout hydrant life.

2. DUAL LUBRICATION is a user option afforded by the 129 for selection of either grease or oil as operating mechanism lubricant. Standard factory procedure is to lubricate with grease. Oil is easily substituted in field by removing operating nut/weathershield bolt and add oil through bolt hole into reservoir. Either lubricant is contained in the chamber by two O-ring seals and water cannot enter when hydrant is operating under pressure.

3. VEHICLE IMPACT protection is afforded by a split safety flange connection at ground line. In the event of a traffic accident, the safety flange breaks and the stem safety coupling separates allowing the above ground hydrant assembly to fall away cleanly from the standpipe flange without any damage to operating components. The 129 can also be rotated 360 degrees for more desirable curb alignment of the nozzle outlets by simply loosening the safety flange bolts and turning the nozzle section.

4. The 4-1/2" or 5-1/4" main valve opening assures high flow capacity. The compression type main valve opens against water pressure and is held shut by this pressure during repair or maintenance. Two drain valves provide quick drainage of the hydrant standpipe following closure of the hydrant. Those drains are self-flushing with each cycle of the main valve. A bronze-to-bronze seat retainer insures easy removal of the main valve should maintenance or repair be required. This is accomplished with a short light weight disassembly wrench.

5. AWWA C502, UL & FM APPROVED

ACCESSORIES/ORDERING



Extension Kit

Conveniently packaged including all necessary parts to raise hydrant in any increment of 6". Specify if hydrant size is 4-1/2" or 5-1/4".

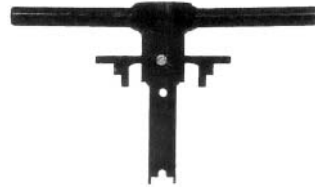

Seat Nozzle

Engages stem coupling for removing main valve seat. Fits either 4-1/2" or 5-1/4" hydrants.



Traffic Repair Kit

Available for 4-1/2" or 5-1/4" hydrant and packaged with all components needed to restore hydrant to service following collision.



Pumper Nozzle Wrench

Slots engage drive lugs in nozzle I.D. for removal. Threads are left hand. Specify nozzle size if other than National Standard.

How To Order

- Model:** M&H style 129. 4-1/2" or 5-1/4" valve opening. Traffic Model AWWA C502 hydrant. Equipped with two 2-1/2" outlets and one 4-1/2" pumper outlet or two 2-1/2" outlets.
- Hose and Pumper Nozzle Threading:** National Standard Specifications (As adopted by National Board of Fire Underwriters)
 Hose Nozzle: 2-1/2" - Threads, 3-1/16" O.D.: 7-1/2 threads per inch.
 Pumper Nozzle: 4-1/2" - Threads, 5-3/4" O.D.: 4 threads per inch.
 Operation Nut: Pentagon - 1-1/2" point to flat.
 Direction of Opening: Left (counter-clockwise)
- Size and Type of Shoe Connection:** 6" Mechanical Joint, Flanged.
- Size and Shape of Operating Nut:** If other than National Standard pentagon measuring 1-1/2" Point to Flat, give dimension measuring point to flat for pentagon and across center from flat to flat for square and hexagon nuts.
- Direction of Opening:** Specify left (counter-clock wise) or right (clockwise). If not specified, open left will be provided.
- Depth of Trench:** Distance from ground line to bottom of connection pipe. "Trench" and "Ditch" are same as "Bury". "Cover" is distance from ground line to top of connecting pipe.
- Color:** Unless otherwise specified, final paint coat will be Fire Hydrant Red.

SPECIFY THE M&H STYLE 929 RELIANT FOR FIRE PROTECTION YOU CAN RELY ON!

• AWWA & ULFM Approved

For over one hundred years, the M&H name has been synonymous with reliability in products for the waterworks industry.

Today, the M&H Style 929 RELIANT fire hydrant offers this same reliability in providing superior fire protection service.

The RELIANT hydrant is engineered to give life-long, maximum performance. Its design features simplify installation and maintenance. It offers trouble-free operation and economy, too. Its rugged construction and unique traffic lug design assure minimal damage on vehicle impact and fast, low cost repair.



Extension Kit - Available for extending hydrant when grade lines are changed. Kit includes one extension section, one length of main valve stem, one breakaway stem coupling, one ring gasket, six non-breakaway lugs and six bolts. When ordering, please specify length of extension in multiples of 6" (such as 6", 12", 18", etc.) and size of hydrant.

Repair Kit - Contains one breakaway coupling with bolts, six breakaway lugs and bolts, and one flange o-ring gasket.

From top to bottom, the RELIANT is one tough hydrant. From its tamper-resistant top works to its 4-1/2" or 5-1/4" main valve opening for high-flow capacity. Plus, the RELIANT meets or exceeds all requirements of the American Waterworks Standard C502 for fire hydrants.

Put simple, you can't buy a better fire hydrant than the M&H RELIANT.

Integral Operating Nut and Weather Shield provide complete protection of the operating mechanism from the elements and the added benefits of tamper-resistant design.

Three-Way Nozzle Section incorporates two hose nozzles and a pumper to insure quick, reliable fire fighting capability. The brass pumper and hose nozzles are easily maintained and replaced with the original M&H "threaded-in brass" concept.



A Unique Traffic Lug Design allows the nozzle section to be rotated a full 360 degrees during or after installation.

Quick-Opening Drain Valve assures complete drainage of the Reliant 929 after its use. During operation a tight seal is achieved between the drain port and main valve...assuring full water pressure at the nozzle.

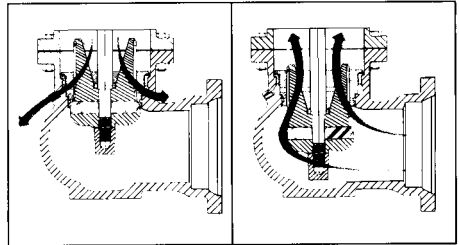

The "Reliant" is available with mechanical joint, flanged and push-on shoes for C900 and ductile iron pipe. Mechanical joint and push-on shoes are equipped with strapping lugs. All hydrant shoes are provided with large blocking pads for ease of installation. Shoes are protected against corrosion with fusion bonded epoxy, I.D. & O.D.



STYLE 929 HYDRANT FEATURES

Designed to be the most reliable municipal firefighting hydrant available, the "Reliant" provides the following features and benefits:

1. Integral Operating Nut and Weather shield provide tamper resistant top works and protects the operating mechanism from the elements. Ease of operation is assured by a nylon anti-friction thrust bearing. A positive top stop stem nut protects the main valve stem, stem coupling and main valve top from potential damages occurring from excessive input torque in the open position.
2. Factory-lubricated with grease, the "Reliant" hydrant can be greased or oil lubricated in the field. This important maintenance requirement of all fire hydrants can be performed by re-greasing or by simply filling the oil reservoir through the weather shield bolt. These reservoirs are dual "O" ring sealed to provide positive prevention of lubricant leakage into the hydrant or water leakage into the bonnet area.
3. A unique field-proved lug arrangement provides full 360 degree rotation of nozzle section. Also assures effective breakaway on vehicle impact and fast, low cost repair. Additionally, the stem coupling between the upper and lower main valve stem fractures on a plane below the level of the standpipe flange. This assures that a vehicle tire cannot depress the main valve after impact.
4. The 4-1/2" or 5-1/4" main valve opening assures high flow capacity. The compression type main valve opens against water pressure and is held shut by this pressure during repair or maintenance. Two drain valves provide quick drainage of the hydrant standpipe following closure of the hydrant. These drains are self-flushing with each cycle of the main valve. A bronze seat retainer insures easy removal of the main valve should maintenance or repair be required. This is accomplished with either a short disassembly wrench or, when preferred, a conventional direct drive wrench to the main valve.

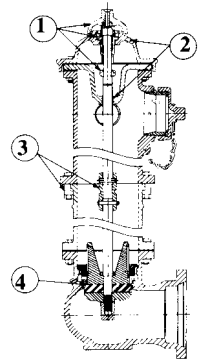

How To Order

1. **Model:** M&H Style 929. 4-1/2" or 5-1/4" valve opening. Traffic Model AWWA C502 hydrant. Equipped with two 2-1/2" outlets and one 4-1/2" pumper outlet.
2. **Hose and Steamer Nozzle Threading:** National Standard Specifications. (As adopted by National Board of Fire Underwriters)
Hose Nozzle: 2-1/2" - Threads, 3-1/16" O.D.: 7-1/2 threads per inch.
Steamer Nozzle: 4-1/2" - Threads, 5-3/4" O.D.: 4 threads per inch.
Operating Nut: Pentagon-1-1/2" point to flat.
Direction of Opening: Left (counter-clockwise)
If other than NST, specify standard by name or send male coupling from discarded section of hose. Do not send hydrant cap.
3. **Size and Type of Shoe Connection:** 6" Mechanical Joint, Flanged, Push-on.
4. **Size and Shape of Operating Nut:** If other than National Standard pentagon measuring 1-1/2" Point to Flat, give dimension measuring point to Flat for Pentagon and across center from flat to flat for square and hexagon nuts.
5. **Direction of Opening:** Specify left (counter-clockwise) or right (clockwise). If not specified open left will be provided.
6. **Depth of Trench:** Distance from ground line to bottom of connecting pipe. "Trench" and "Ditch" are same as "Bury". "Cover" is distance from ground line to top of connecting pipe.
7. **Color:** Unless otherwise specified, final paint coat will be Fire Hydrant Red.

Available Accessories

Disassembly Wrench - Main valve can be removed with a short, lightweight disassembly wrench. If desired, a direct drive wrench that engages the main valve itself is available.

Style 28 Spanner Wrench - Operation and spanner wrench furnished in one tool. A span-



ner to attach or remove the hose coupling; a wrench to remove nozzle caps and operate the main hydrant valve; and a wrench to fit hold-down nut when disassembling hydrant. State size and shape of operating nut when ordering extra wrenches.

M&H 2-1/4 FIRE HYDRANTS
 • Post Type Styles 33, 133, & 233
 • Flush Model Style 333

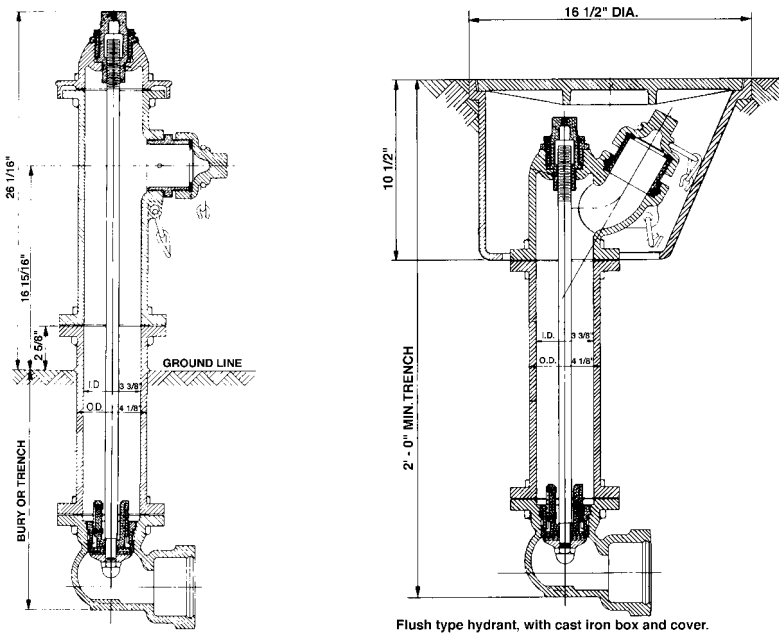

Post type hydrants are special purpose hydrants for use where fire fighting is not the primary function. They are smaller in size than standard AWWA hydrants and are furnished with main valve opening diameter of 2-1/4".

They are often used for wash down service at treatment plants. Other uses may be in rural water systems to flush, bleed air pockets or fill fire department tank trucks.

Although 2-1/4" post type models are not recognized by AWWA C502 standards for dry barrel fire hydrants, they are nonetheless manufactured to the same strict quality of materials and workmanship as full size M&H hydrants.

Rated working pressure is 150 psi and each hydrant is hydrostatically tested to 300 psi.

Two basic styles are available, the post type with nozzle section extending above ground and the flush type for concealment below grade line. The flush type can be furnished with a cast iron box and cover for easy access. The box is not attached to the hydrant to prevent load bearing on any part of the installed hydrant.

Several options for end connections and hose nozzles are offered and shown below.

- Style 33 Post type has one 2-1/2" hose nozzle.
 - Style 133 Post type has one 1-1/2" hose nozzle.
 - Style 233 Post type has two 1-1/2" hose nozzles.
 - Style 333 Flush type has one 2-1/2" hose nozzle.
- Available shoe inlet connections are:
- Mechanical Joint; 2" or 3".
 - Flanged Joint; 2", 2-1/2" or 3".
 - Screwed Joint; 2" or 2-1/2".

M&H FIRE HYDRANTS
• **AWWA Compression Type**
• **How to Order**

1. **Model:** Style 129,929
2. **Size of Hydrant Valve Opening:** 4-1/2" and 5-1/4".
3. **Number and Size of Hose Nozzles:** Two. Usually 2-1/2".
4. **Hose Nozzle Threading:** If other than National Standard, specify standard by name or send male coupling from discarded section of hose, so that hose connections can be accurately measured. Do not send hydrant cap as this is not an accurate gauge.
5. **Number and size of Steamer Nozzles:** One. Usually 4-1/4".
6. **Steamer Nozzle Threading:** Same instructions as No. 4
7. **Size of Shoe Connection:** 4-1/2" Hydrants; 4" or 6" Shoe. 5-1/4" Hydrants; 6".
8. **Type of Shoe Connection:** Mechanical Joint, Flanged.
9. **Size and Shape of Operating Nut:** If other than National Standard pentagon measuring 1-1/2" Point to Flat, give dimension measuring Point to Flat for pentagon and across center from flat to flat for square and hexagon nuts.

Figure 1 Figure 2 Figure 3 Figure 4

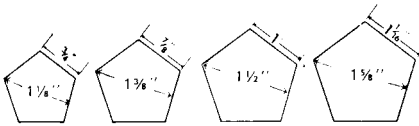

10. **Direction of Opening:** Whether to left (counter-clockwise) or to right (clockwise). Open left supplied if not specified.
11. **Depth of Trench:** Distance from ground line to bottom of connecting pipe. "Trench" and "Ditch" are the same as "Bury". "Cover" is the distance from the ground line to top of connecting pipe.
12. **Color:** Unless otherwise specified, final paint coat will be Fire Hydrant Red.
13. **Bronze to bronze seat is standard.**
The nut for opening hydrant and nut on nozzle



caps will always be made pentagon (five-sided), unless otherwise ordered. When an established wrench nut is in use, send template of same or nozzle cap. Samples are unnecessary when National Standard operating units are used. State whether to turn left or right to

open. Unless otherwise ordered, all hydrants will be made to turn *Left* in opening.

Operating and spanner wrench furnished in one tool. A wrench to remove nozzle caps and to operate the main hydrant valve, and a wrench to fit hold-down nut when disassembling hydrant.

STYLE 28 SPANNER WRENCH



State size and shape of operating nut and size of valve opening of hydrant when ordering extra wrenches.

Main valve disassembly wrenches are for removing main valve sub-assembly intact with lower rod, traffic coupling and upper rod. Using the wrench, the main valve seat is released by turning counter-clockwise to unscrew it from the permanent bronze seat retainer ring in the shoe. Once the threaded connection is free, lift the entire main valve seat and rod vertically through the nozzle section.



The long, direct drive disassembly wrench can be used on either Style 929 or 129 hydrants and engages integral lugs on main valve seat.

The short disassembly wrench is designed to engage the square shape of the traffic coupling on all Styles M&H 929/129 and can also be used on Style 129 hydrants manufactured since 1988.

NATIONAL STANDARD SPECIFICATIONS
(As adopted by National Board of Fire Underwriters)

Hose Nozzle: 2-1/2" I.D.; 3-1/16" O.D.; 7-1/2 threads per inch.

Steamer Nozzle: 4-1/2" I.D.; 5-3/4" O.D.; 4 threads per inch.

Operating Nut: Pentagon - 1-1/2" point to flat.
Direction of Opening: Left (counter-clockwise)

•UL & FM APPROVED

MEDALLION COMPRESSION-TYPE FIRE HYDRANT

AWWA C502 Standard



F-2545 Medallion Hydrant



Mountain Hydrant

DESCRIPTION

The Clow MEDALLION Fire Hydrant truly represents state of the art design and engineering resulting in unsurpassed water delivery with minimum maintenance. Each interior component has been subjected to painstaking computer analysis and design to insure that loss-of-head through the hydrant is kept to the lowest level possible.

All materials used in construction of the MEDALLION have been chosen to provide virtually effortless operation at its rated working pressure of 200 psi.

- Delrin anti-friction bearings above and below the thrust collar provide low-torque operation throughout the opening and closing cycles.

- The specially designed lubrication reservoir utilizes O-ring seals to keep the water out and the lubrication in, thereby insuring that the operating threads are properly lubricated for smooth operation.

- A strong, durable cast iron weather shield protects the operating mechanism under all weather conditions.

The solid bronze, virtually corrosion proof nozzles utilizing O-ring seals can easily be replaced in the field.

Threaded into the bronze drain ring is the solid bronze seat ring. This bronze to bronze construction permits easy removal of the main valve for inspection. The main valve facing is durable urethane rubber providing tight sealing and excellent wear characteristics.

A 360 degree drain channel coupled with double drain ports insure that the hydrant will drain completely after use. Drain valve facings are solid urethane rubber providing effective sealing and long life.

From top to bottom, inside and out, the Clow MEDALLION Fire Hydrant is unsurpassed for providing long and reliable fire protection.

The Clow MEDALLION Fire Hydrant is also available as a "mountain hydrant". This feature allows the dimension from the ground-line to the centerline of the pumper nozzle to vary in manufacturing, as specified by the end user. Most common installations are for areas with heavy snowfall to keep the hydrant nozzles available but maintaining the ground-line break-off feature.

**MEDALLION COMPRESSION-TYPE
FIRE HYDRANT (CONTINUED)
AWWA C502 Standard**

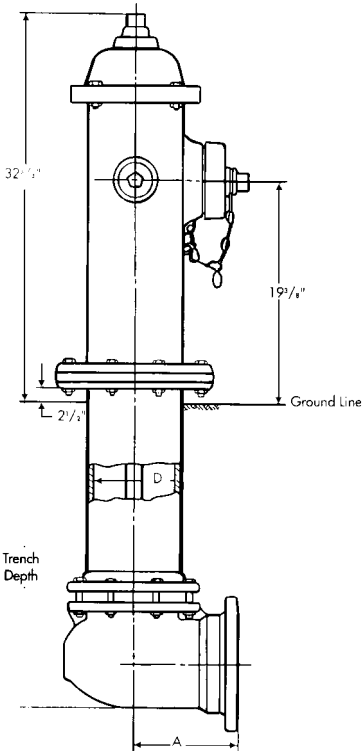

The Clow Medallion Hydrant features a universal safety flange and stem coupling assembly consisting of breakaway parts that shear cleanly without fragmentation. In the event of an accident, the danger of water loss and damage to the main valve itself is eliminated. The safety flange is gray cast iron and the safety stem coupling is steel tubing held in place with stainless steel pins equipped with stainless steel cotter pins.

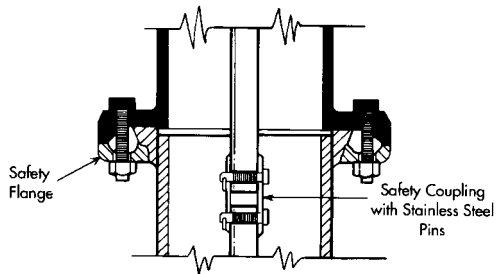

**Section Showing
Safety Flange & Coupling**

HYDRANT VALVE SIZE	DIMENSION D INCHES
4-1/2"	6.16*
5-1/4"	7.04*

*± .14"

INLET END TYPE	DIMENSION A INCHES
FLANGE	8-1/8"
MECHANICAL JOINT	9"
PUSH-ON	9-5/8"

**CLOW COMPRESSION-TYPE
FIRE HYDRANT
AWWA C502 Standard**



F-2500 Clow Hydrant Showing two 2-1/2" hose nozzles one pumper nozzle.

DESCRIPTION

The Clow Fire Hydrant is designed and built for efficient, dependable fire protection. It is a center stem, compression style hydrant with smooth, interior contours that provide high flow with minimum head loss. When the hydrant is operated, the main valve moves away from its seat easily and quickly delivering a full flow of water to the nozzles.

Delrin bearings above and below the thrust collar on the bronze operating nut and the sealed oil reservoir that provides constant lubrication of the stem threads, combine to assure easy, low torque operation. As the hydrant is opened, an automatic bronze drain valve closes to prevent the loss of water during use. When the hydrant is closed, the drain is open permitting water in the standpipe to drain out after use.

FEATURES

- All internal parts can be removed through the top of the hydrant without digging. The main valve is easily removed with a short, light-weight wrench regardless of trench depth. A bronze drain ring provides bronze-to-bronze threading between the main valve seat ring and drain ring.
- If damaged, the weatherproof bronze operating nut is easily replaced by simply removing the bronze thrust nut.
- The ductile iron standpipe is virtually unbreakable and corrosion resistant.
- The groundline safety flange allows 360° rotation of the standpipe for easy, flexible positioning of the nozzle section.
- Hydrants are available with 6-inch inlets having Standardized Mechanical, Flanged or Push-On joints.

**CLOW COMPRESSION-TYPE
FIRE HYDRANT (CONTINUED)**
Clow Traffic Model With Safety Flange Construction

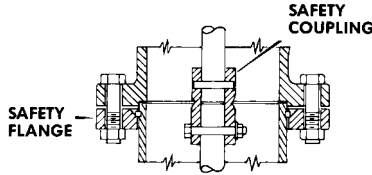

Section showing Safety Flange and Coupling

The Clow Hydrant incorporates an advanced safety flange and coupling system that prevent damage to the main valve or other internal parts in the event of an accidental impact.

The safety coupling is held to the lower stem by a stainless steel bolt and to the upper stem by a stainless steel Driv-Lok pin. Both fasteners are easily removed and are re-usable. It is this feature that permits easy extension of the hydrant at any time.

The Clow safety flange design gives added protection against flooding and eliminates the potential expense of digging up a damaged hydrant for repair or replacement.

F-2500 CLOW HYDRANT DIMENSIONS

Dimension "A" in Inches

INLET END TYPE	DIMENSION A
FLANGE	9
MECHANICAL JOINT	10-1/2
PUSH-ON FOR DUCTILE IRON	10-1/2

*Applies to both 4-1/2" and 5-1/4" Hydrant

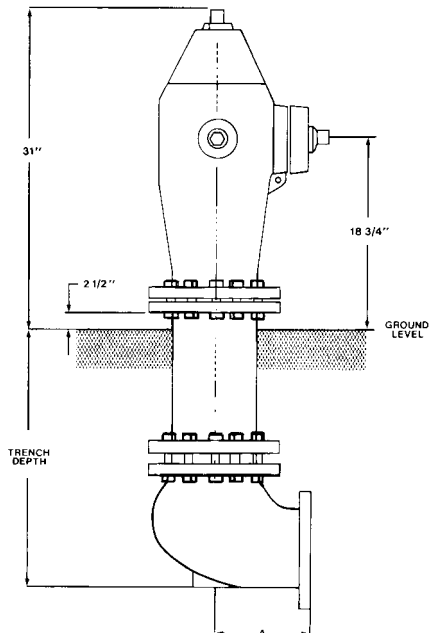

EDDY COMPRESSION-TYPE FIRE HYDRANTS

*Tested to 300 Pounds Hydraulic Pressure
Recommended for 150 Pounds Water Working Pressure*

Eddy Fire Hydrants are designed and built for dependable, long lasting fire protection. Eddy Hydrants equal or exceed all requirements of American Water Works Association C502 Standard.

The Eddy Fire Hydrant is a center stem type with a hydrant valve that opens with the pressure as opposed to opening against the pressure, which is a characteristic of other center stem type hydrants.

Because it opens with the pressure, water pressure in the main actually assists in opening the hydrant, providing water to nozzles quickly. The stem is supported at the top and the bottom of the hydrant and moves in direct line with the hydrant standpipe. Misalignment of the main valve with its seat is impossible.

In closing, the hydrant valve is drawn gradually and smoothly to its solid bronze seat. No chance of water hammer because the valve, closing against the pressure cannot jump to its seat. Free to revolve on the stem, the valve becomes stationary as it comes in contact with the seat. Scoring or marring of either the seat ring or valve face is prevented.

In the closed position, the hydrant valve is held in place from below by the threaded portion of the stem. Damage to either the upper or lower hydrant standpipe will not result in any loss of water.

The sturdy, independent drain rod provides complete, automatic drainage of the hydrant after use and is closed quickly by one and one half opening turns of the operating nut preventing water loss while the hydrant is being used.

A drainless hydrant, the F-2641 Eddy, is available for those installations where automatic draining is not required or needed.



Eddy BF Hydrant

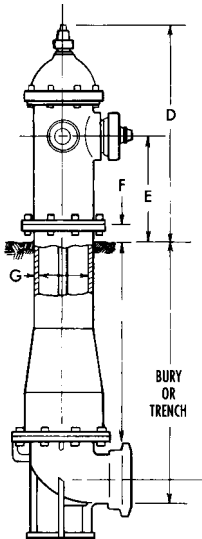

HYDRANT DIMENSIONS - INCHES

DIMENSIONS	SIZE MAIN VALVE OPENING		
	4-1/4 AND 4-1/2 INCH	5-1/4 INCH	
	4-INCH INLET	6-INCH INLET	6-INCH INLET
BREAK FLANGE HYDRANT			
B	9-1/4	9-1/4	9-1/4
C	9-1/4	9-1/4	9-1/4
D	34	34	34
E	18	18	18
F	2-3/4	2-3/4	2-3/4
G	6-1/2	6-1/2	7-1/4

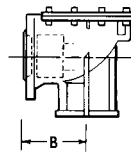

Mech. Joint Inlet

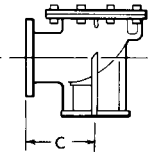

Flanged Inlet

F-90 SERIES FIRE HYDRANTS

*Equal or exceed requirements of
American Water Works Association C503 Standard*

The F-90 Series Clow wet barrel Fire Hydrants were designed to provide dependable fire protection while at the same time presenting a slim line, low silhouette that would prove to be harmonious with modern architecture.

The valve is the time proven standard Type "B" design with all bronze working parts and a urethane rubber valve facing. All working parts can easily be removed through the outlet port for routine examination and maintenance.

To insure against water loss should the hydrant be subjected to an impact fracture, a #400 break-off check valve can be furnished.



F-92-3 Way
2 - 2-1/2" hose outlets and either
1 - 4" or 1 - 4-1/2" steamer outlet

DIMENSIONS - INCHES

	F-92	F-94
OVERALL HEIGHT OF BODY	18-1/4"	18"
OVERALL WIDTH OF BODY	31-1/8"	22-1/2"
DISTANCE OF HOSE OUTLETS FOR SPANNER WRENCH CLEARANCE	12"	12"
DISTANCE FROM CENTER LINE OF HOSE OUTLET TO FACE OF BOTTOM FLANGE	13"	13"
NUMBER AND SIZE OF HOSE OUTLETS	2 - 1/2" 1 - 4" OR 4-1/2"	1 - 2-1/2" 1 - 4" OR 4-1/2"

F-70 SERIES FIRE HYDRANTS

*Equal or exceed requirements of
American Water Works Association
C503 Standard*

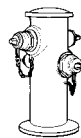

F-74

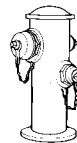

F-75

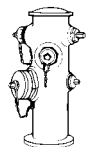

F-76

The F-70 Series Wet Barrel Fire Hydrants are a new improved model of the most widely used California type, independently valved hydrant. Their proven design and outstanding reliability are the reasons for their wide-spread acceptance. The body is cast from high strength cast iron for long life. Working parts are kept to a minimum and are carefully machined of bronze to assure long, trouble free service. All working parts can easily be removed by unscrewing the outlet valve seat.

A break-off check valve can be furnished to provide instantaneous shut-off of water should the hydrant be broken by collision.

These hydrants can also be furnished with a 2" or 2-1/2" pipe connection on top so that a wharf hydrant (angle hose valve) may be added for additional fire protection, for filling sprinkling equipment or other uses.

DIMENSIONS FROM BOTTOM FLANGE OF BODY - INCHES

	F-74	F-75	F-76
NUMBER OF OUTLETS	TWO 2-1/2"	STEAMER & 1 - 2-1/2"	STEAMER & 2 - 2-1/2"
OVERALL	24-1/2	26-1/2	29-3/4
TO CENTERLINE OF TOP OUTLET	17-1/2	19 (STEAMER)	23-1/2
TO CENTERLINE OF 2ND OUTLET	13	13	19
TO CENTERLINE OF 3RD OUTLET	-	-	13 (STEAMER)

F-800 SERIES FIRE HYDRANTS
*Equal or exceed requirements of
American Water Works Association C503 Standard*

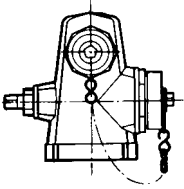

F-810

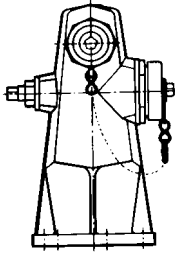

F-850

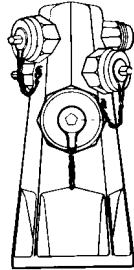

F-860

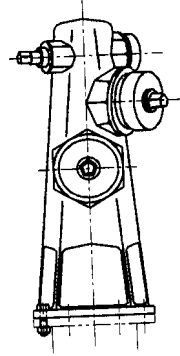

F-865

The F-800 Series Wet Barrel Fire Hydrants are designed to provide low cost dependable fire protection. The high strength cast iron body is completely lined with a fusion bonded epoxy lining which insures that the hydrants high flow characteristics will be maintained.

All working parts can easily be removed through the outlet for inspection and routine maintenance.

Corrosion proof, durable plastic nozzle caps are standard however, cast iron caps will be furnished when specified.



MODEL	WEIGHT POUNDS	OUTLETS
810	70	(1)-2-1/2" (1)-4" - 4-1/2"
850	115	(1)-2-1/2" (1)-4" - 4-1/2"
860	135	(2)-2-1/2" (1)-4" - 4-1/2"
865	150	(1)-2-1/2" (2)-4" - 4-1/2"

EAST BAY SERIES FIRE HYDRANTS
Equals or exceeds requirements of
American Water Works Association C503 Standard



#5 East Bay

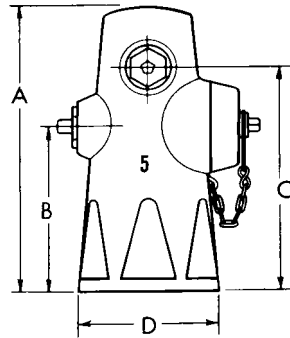

Dependable fire protection coupled with a modern, streamlined design make the East Bay Series Wet Barrel Fire Hydrant the choice of municipalities that demand the best. Designed with high strength cast iron bodies and solid bronze working parts these hydrants provide years of trouble free service and long life.

The carrier valve is the widely accepted Standard MGS Type "B". Routine inspection and maintenance are easily performed as the carrier assembly is accessible through the outlet port.

EAST BAY SERIES DIMENSIONS

MODEL	DIMENSIONS - INCHES			
	A	B	C	D
F-5 OUTLETS: 1-2-1/2" & 1-4-4-1/2" 1-3" & 1-4-1/2"	24	13-7/8	18-7/8	11-1/2

F-2000 SERIES SOLID BRONZE FIRE HYDRANTS
200psi Working Water Pressure - 400 psi Test Pressure
Clearly meet or exceed requirements of
American Water Works Association C503 Standard



2060

The Clow 2000 Series Wet Barrel Fire Hydrants reflect a degree of engineering excellence unequalled in the industry. While durability and strength are important features of these solid bronze hydrants, reliable fire protection is their hallmark.

The outlets are easily removed and all internal parts can be removed through the outlet port for routine inspection and maintenance without removing the hydrant head from the bury section. Valve rubbers are made from urethane rubber which is both abrasion and nick resistant.

The high strength 85-5-5-5 bronze used for the body casting conforms to both ASTM B62 and AWWA C503 Standards. Heavy duty, contoured plastic caps are standard but bronze caps are available.

MODEL	APPROXIMATE WEIGHT-LBS	OUTLETS
2010*	65	(1)-2-1/2" (1)-4/4-1/2" w/6" IPS BARREL
2050*	98	(1)-2-1/2" (1)-4/4-1/2"
2060	115	(2)-2-1/2" (1)-4/4-1/2"
2065	135	(1)-2-1/2" (2)-4/4-1/2"

*2-1/2" tapped plug on top can be furnished when specified.

CLOW WET BARREL HYDRANT BURYS



Clow Buries for use with Wet Barrel Fire Hydrants are manufactured to strict quality control standards and equal or exceed all applicable requirements of American Water Works Association C503 Standard, Wet Barrel Hydrants.

Ruggedly designed and cast of high strength cast iron, Clow Buries are perfectly matched to the full line of Clow Wet Barrel Hydrants. Buries are available in a wide range of lengths to meet virtually any installation requirements.

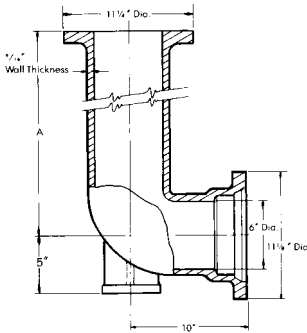

F-2450 Bury Mechanical Joint

DIMENSION A INCHES
10
12
16
18
22
24
30
36
42
48
54

Also available in flanged and push-on end connections.



#400 BREAKOFF CHECK VALVE ASSEMBLY

The #400 Breakoff Check Valve Assembly is a valuable safe guard for hydrants to prevent property damage and the loss of water. The #400 Breakoff Check Valve Assembly automatically shuts off the flow of water without water-hammer in the event a hydrant is struck. Available for use on all models of Wet Barrel hydrants with minimum bury of 30".

FIRE HYDRANTS ORDERING INFORMATION

When placing orders or making inquiries, please furnish the following information. This information will enable us to answer your questions, prepare quotations, and fill your order promptly. Lack of essential information is almost sure to cause delays.

Use Figure Number wherever possible to identify the product wanted.

ORDERING INFORMATION - HYDRANTS

1. **Quantity and style.**
2. **Construction:** whether Standard Ground Line, or Safety Flange.
3. **Size of main valve opening:** 4-1/4", 4-1/2", or 5-1/4".
4. **Number of 2-1/2" hose nozzles.**
5. **Number and size of pumper nozzles.**
6. **Type of inlet connection:** flanged, mechanical joint, push-on, etc.
7. **Size of inlet connection:** 4-, or 6-inch.
8. **Depth of trench or bury:** Distance from ground line to bottom of connecting pipe.
9. **Direction of opening:** Usually open to left (counter clockwise); open right (clockwise), when specified.
10. **Size and shape of operating nut:** National Standard is 1-1/2" pentagon measured from point to opposite flat at base of nut.
11. **Hose and pumper nozzle threads:** If other than National Standard, thread specification and nut size must be furnished in the following manner:
 - (a) Send sample nozzle or male hose coupling; or
 - (b) Send drawing giving complete thread specification; or
 - (c) Refer us to previous hydrant order. Complete records are kept of all installations.
12. **Color:** Specify color of paint wanted.



F-2750

Adjustable Hydrant Wrench with Spanner
Fits both Pin type and Rocker type hose couplings.

**UNDERWRITERS AND FACTORY MUTUAL
FIRE HYDRANTS**

F-2505
UL/FM Clow



Fire Hydrant
F-2536
UL/FM Medallion

COMPRESSION TYPE

The F2536 Medallion and the F2505 Clow Fire Hydrants are listed by the Underwriters Laboratories, Inc. and Associated Factory Mutual Companies for use in industrial fire protection systems.

For easy visual identification of the hydrants, each has marked on the nozzle section the letters UL & FM. Both hydrants are furnished with a 5-1/4" valve opening and 6" inlet.

NATIONAL STANDARD HOSE COUPLING THREAD SPECIFICATIONS (NST)

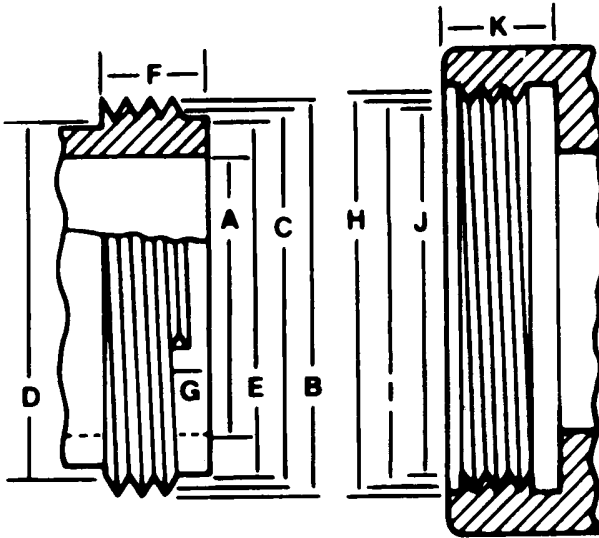

All dimensional data and tolerances are in accord with ANSI 26

A. NOMINAL INSIDE DIAMETER		2-1/2"	3"	3-1/2"	4"	4-1/2"
NUMBER OF THREADS PER INCH		7 1/2	6	6	4	4
B. MAJOR DIAMETER NOZZLE THREAD	MAX.	3.0686	3.6329	4.2439	5.0109	5.7609
	MIN.	3.0366	3.5879	4.2079	4.9609	5.7109
C. PITCH DIAMETER NOZZLE THREAD	MAX.	2.9820	3.5156	4.1356	4.8485	5.5985
	MIN.	2.9660	3.4976	4.1176	4.8235	5.5735
D. MINOR DIAMETER NOZZLE THREAD	MAX.	2.8954	3.4073	4.0273	4.6861	5.4361
E. DIAMETER PILOT NOZZLE		2.8500	3.3540	3.9730	4.6100	5.3570
F. LENGTH OF THREAD - NOZZLE		1"	1-1/8"	1-1/8"	1-1/4"	1-1/4"
G. FACE TO START OF SECOND TURN		1/4"	5/16"	5/16"	7/16"	7/16"
H. MAJOR DIAMETER COUPLING THREAD	MIN.	3.0836	3.6389	4.2639	5.0359	5.7859
I. PITCH DIAMETER COUPLING THREAD	MAX.	3.0130	3.5486	4.1736	4.8985	5.6485
	MIN.	2.9970	3.5306	4.1556	4.8735	5.6235
J. MINOR DIAMETER COUPLING THREAD	MAX.	2.9424	3.4583	4.0833	4.7611	5.5111
	MIN.	2.9104	3.4223	4.0473	4.7111	5.4611
K. DEPTH OF COUPLING		15/16"	1-1/16"	1-1/16"	1-3/16"	1-3/16"

INSTALLATION

1. When hydrants are received from manufacturer they should be handled carefully to avoid breakage and damage to flanges. Keep hydrants closed until they are installed. Protect stored hydrants from the elements, if possible.
2. Before installation of hydrants clean piping and elbow of any foreign matter.
3. Install hydrants away from the curb line a sufficient distance to avoid damage from or to overhanging vehicles. A set-back of 2 ft. from the curb line to the point on the hydrant nearest the curb is recommended. The pumper outlet nozzle should face the street. Make sure that the outlet nozzles are high enough above the ground line for hose attachment and that there are no obstructions to prevent operation.

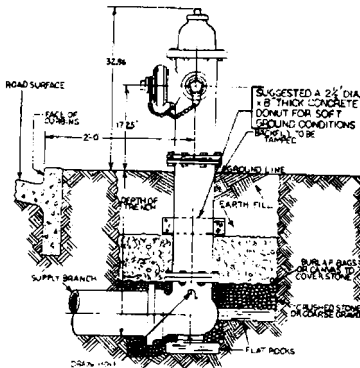

In setting up a hydrant, the elbow should be placed on a flat stone or other solid foundation. It is good practice to brace the side of the base opposite the inlet to oppose the stress due to pressure tending to force the hydrant off the end of the lateral. Hydrants must be firmly supported underground all around the standpipe, especially where there is no concrete sidewalk to help support them. This is particularly important since the proper working of the Safety Breakable Section in severe impact depends upon unyielding support of the underground standpipe.

4. The bottom and lower part of the hydrant should be surrounded with broken stone or coarse gravel so that the water released from the standpipe by the drain valves may escape quickly. The stone-filled area should contain a volume of water at least twice that held by the hydrant barrel.
5. Both drainage stone and earth fill above the stone should be tamped to give firm support to the hydrant barrel.

6. It is recommended practice to install an auxiliary or secondary gate valve in the lateral between the hydrant and the main. This permits inspection and repair of hydrant without shutting down mains. Check the hydrant and auxiliary valve for perpendicular setting.
7. After the hydrant is installed and the line as well as the hydrant have been hydrostatically tested, the hydrant should be flushed and then checked for proper drainage.
 - A. A nozzle cap should be removed, then the hydrant opened fully. This will flush out any dirt or sediment which may have accumulated during installation. After the hydrant is flushed, close it, replace the nozzle cap, then open the hydrant again and inspect all joints for leaks: Close the hydrant again, remove a hose cap and/or steamer cap to test your hose thread for proper fit.
 - B. Before replacing the hose cap and/or steamer cap, check the inside of the hydrant for drainage. This can be accomplished by placing the palm of the hand firmly over the nozzle outlet. Drainage rate should be sufficiently rapid to create suction.

Note: In certain areas ground water stands at levels above that of hydrant drains. In such cases it is recommended that hydrant drains be plugged at the time of installation. If drains are plugged, hydrants in service in cold climate areas should be pumped out after usage. Mark such hydrants to indicate the need for pumping out after usage.

OPERATION

The hydrant requires a minimum of torque to be operated. It is possible to damage the hydrant by forcing it beyond the limits of the operating nut travel with excessive torque; therefore, the following steps are recommended:

1. CHECK DIRECTION OF OPENING as marked on the dirt shield.
2. TO OPEN, DO NOT FORCE THE HYDRANT IN THE OPENING DIRECTION BEYOND FULL OPEN as indicated by sudden resistance to turning. If water does not flow when the hydrant is open, it is probably due to a closed valve upstream from the hydrant.
3. WHEN USING HYDRANT, hydrant should be opened full. Partially opened hydrant may allow substantial leakage through the drain valves. This may prevent the hydrant from draining properly when it is shut down. Operation of hydrant in this

manner over a period of time could also undermine the hydrant and/or the water main.

4. TO CLOSE, turn the operating nut until the valve closes off the flow. Always shut off hydrant slowly. In old water mains where corrosion has taken its toll, or even on new mains where high pressure is maintained, closing the hydrant too rapidly could cause a water hammer resulting in damage to the main.

IT IS NOT NECESSARY to OPEN or CLOSE the hydrant with great force. When closing the hydrant, the closed position will be evident by a reduction in the effort required to close it. When that position has been reached, back off the operating nut in the opening direction one-quarter turn to take the strain off the operating parts of the hydrant and to make it easier to open the hydrant when needed again.

MAINTENANCE

It is recommended the hydrant be inspected twice yearly, in the spring and fall. In extremely cold weather it is advisable to inspect hydrant after each use.

Maintenance and adjustments are easy and economical. All parts which are susceptible to damage or rough treatment can be reached without excavation or expensive equipment. The main valve, seat ring, drain valve, drain valve seat and the stem may all be easily withdrawn and replaced by one man.

Inspection or renewal are practical without disturbing the standpipe, pavement or mains. Inspection should cover the following points:

1. Physical examination noting condition of operating nut, nozzle caps and drains, and general appearance.
2. Use an Aquaphone and listen for leakage through main valve.
3. To check for leakage at seals loosen one hose cap one-half turn. Check ease of operation while fully opening hydrant. When all the air has escaped through the hose cap and the hydrant is full, re-tighten the hose cap and check for leakage at joints, packing or seals, and outlet caps.
4. Close the hydrant and remove one nozzle cap. Observe drainage.
5. Open hydrant completely, flush hydrant and observe flow. Care should be taken that the water coming from hydrant will not cause any damage to surrounding area.
6. Close hydrant slowly to insure tight closure.
7. Clean and lubricate all nozzle threads.

Replace caps, tighten with spanner wrench, then back off slightly so that the caps will not be excessively tight, but have sufficient frictional resistance to prevent removal by hand.

8. Lubricate stem threads through the Alemite fitting centered in the operating nut (one or two pumps with a grease gun).
9. Clean the exterior of the hydrant and repaint, if necessary.
10. Be sure any auxiliary valves are in the wide open position.
11. Keep complete records on inspection and location of all hydrants in the system.

PROBLEMS AND SOLUTIONS

Various problems which occur in the field are described below with hints on how to solve them.

Stem Binding: Rap the hydrant dome with hammer or spanner wrench. This often will unbind the stem. If stem still binding, loosen dome bolts. Stem should then operate easily. Retighten bolts evenly.

Poor Drainage: It is possible dirt or pebbles may have plugged the drain holes. Presence of water or ice standing in barrel can be checked using a plumb bob.

To correct:

1. Screw nozzle caps on tightly to prevent leakage.
2. Open hydrant slowly until you hear water entering barrel of hydrant. This will allow water to enter the hydrant with drain valve in an open position. When enough pressure builds up in the barrel any dirt or foreign objects causing the blockage should be forced out.
3. After a few minutes, resume turning the operating nut until the hydrant is fully opened.
4. Slowly shut off hydrant.
5. Remove one of the nozzle caps.
6. Observe through nozzle port to make sure water in barrel is receding. Drainage should be sufficiently rapid to create a suction if palm of hand is placed over a nozzle outlet during drainage.
7. Check again for seat leakage with the Aquaphone.

Poor Shutoff: DO NOT exert extra torque forcing hydrant to close. Trouble may be a stone lodged between the seat and the main valve. Forcing closure may damage the hydrant. Stones or other foreign objects are the usual causes of this problem. To correct this problem, remove one or both nozzle caps and

open hydrant fully to flush out any foreign material.

Care should be taken that water coming from hydrant will not cause any damage to surrounding area. Attach a canvas apron if necessary, to direct the flow into the street.

Shut off hydrant slowly until fully closed. Put your ear to nozzle opening to hear if water has stopped coming through main valve.

**SECTION III. FIRE HYDRANTS
INDEX****A**

Applicable Standards for Fire Hydrants (ANSI/AWWA Standards)	223
---	-----

B

Burys, Wet Barrel	128
-------------------	-----

C

Clow #400 Break-off Check Valve Assembly	128
Clow F2500	120, 121, 129
Clow F2505 UL/FM	130
Clow F2536 UL/FM	130
Clow Medallion	118, 119, 129
Clow Series F-70	123, 129
Clow Series F-90	123, 129
Clow Series F-800	124, 129
Clow Series F-900	125, 129
Clow Series F-2000 Bronze	127, 129

E

East Bay Series Hydrants	126, 129
Eddy Fire Hydrants	122, 129

F

Fire Hydrants:	
Clow F2500	120, 121, 129
Clow Medallion	118, 119, 129
Eddy Fire Hydrants	122, 129
Kennedy Guardian	106-110
Kennedy Guardian Monitor	111
M&H Style 129	112, 113, 117
M&H Style 929	114, 115, 117
M&H Styles 33, 133 & 233	116
M&H Flush Model Style 333	116
Ordering Information	110, 113, 115, 117, 129
Underwriters and Factory Mutual:	
Clow F2505	130
Clow F2536	130
Wet Barrel:	
#400 Break-off Check Assembly	128
Burys	128
East Bay	126, 129
F-2000 Series Bronze	127, 129
Series F-70	123, 129
Series F-90	123, 129
Series F-800	124, 129
Series F-900	125, 129

G

Guardian Fire Hydrant	106-111
-----------------------	---------

	H	
History of Fire Hydrants		105
Hydrants		(See Fire Hydrants)
Hydrant Wrenches		108, 115, 117, 129
	I	
Installation Information		132
	K	
Kennedy Guardian		106-110
Kennedy Guardian Monitor		111
	M	
M&H Style 129		112, 113, 117
M&H Style 929		114, 115, 117
M&H Styles 33, 133 & 233		116
M&H Flush Model Style 333		116
Maintenance Information		133
McWane, Inc. Division Offices		i
	N	
National Standard Hose Coupling Thread Specs		131
	O	
Operating Information		132, 133
Ordering Information		110, 113, 115, 117, 129
	P	
Problems and Solutions		133, 134
	R	
Ransom Industries, Inc. Division Offices		i
	T	
Terms		ii
	U	
Underwriters and Factory Mutual:		
Clow F2505		130
Clow F2536		130
	W	
Warranty		ii
Wet Barrel Fire Hydrants (see also: Fire Hydrants)		123-129
Wrenches, Hydrant		108, 115, 117, 129

VALVES

CLOW VALVE COMPANY

KENNEDY VALVE COMPANY

M & H VALVE COMPANY

This page intentionally left blank.

PIPE
ECONOMY

CONTENTS

Resilient Wedge Valves	149
Metropolitan Gate Valves	154
Double Disc Gate Valves	156
Cutting-In Valves	161
Extra Heavy Pressure Gate Valves	162
By-Pass Valves	164
Double Disc Gate Valve Accessories	165
Gate Valve Ordering Information	167
Silent Check Valves	168
Plug Valves	169
Indicator Posts and Valves	173
Swing Check Valves	178
Increasing Type Check Valves	181
Iron Swing Check Valves	183
Grooved Check Valves	185
Grooved End Butterfly Valves	188
Mud Valves	192
Flap Valves	193
Shear Gates	194
Floor and Bench Stands	195
Pressure Relief Valves	198
Other Butterfly Valves	200
Index	224

This page intentionally left blank.

PIPE
ECONOMY

CLOW / KENNEDY / M&H AWWA RESILIENT WEDGE VALVES

DELTRIN THRUST BEARINGS ABOVE AND BELOW THE THRUST COLLAR REDUCE FRICTION AND MINIMIZE OPERATING TORQUES.

TWO O-RING SEALS ARE REPLACEABLE WITH THE VALVE FULLY OPEN AND SUBJECTED TO FULL-RATED WORKING PRESSURE.

ELECTRO-PLATED NUTS AND BOLTS PROVIDE LONG-LIFE CORROSION PROTECTION.

O-RING SEALS AT STUFFING BOX, BELOW THE THRUST COLLAR, AND BONNET TO BODY FLANGES TO ENSURE THE BEST POSSIBLE SEAL.

LONG, TROUBLE FREE LIFE WITH HIGH STRENGTH, NON-CORROSIVE BRONZE STEM AND STEM NUT.

CORROSION RESISTANT FUSION-BONDED EPOXY COATING PROTECTS BOTH INSIDE AND OUTSIDE OF VALVE.

100% COATED WEDGE ENSURES BUBBLE-TIGHT SEAL EVERY TIME UP TO 250 PSI.

SMOOTH, UNOBSTRUCTED WATERWAY IS FREE OF POCKETS, CAVITIES, AND DEPRESSIONS ALLOWING FOR MINIMAL FLOW LOSS AND LOWER PUMPING COSTS. ALL TAPPING VALVES ACCEPT FULL SIZE TAPPING CUTTER.

2"-12" VALVES ARE RATED AT 250 PSI FOR AWWA SERVICE AND 200 PSI FOR ULFM SERVICE. ALL VALVES ARE HYDROSTATICALLY TESTED TO 500 PSI.

PADS ON THE BOTTOM OF ALL VALVES KEEP VALVE IN UPRIGHT POSITION FOR EASIER STORAGE AND PROTECTION FROM THE ELEMENTS.

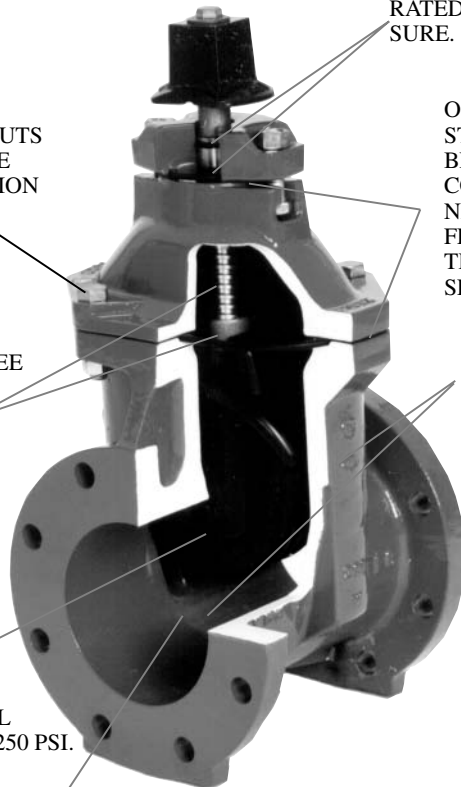

PRESSURE RATING

VALVE SIZE INCHES	WORKING PRESSURE PSI	BUBBLE-TIGHT TEST, PSI	HYDROSTATIC SHELL TEST, PSI
2-12	200 (ULFM)	250 (AWWA)	500
14-24	200	200 (AWWA)	400

CLOW / KENNEDY / M&H 2"-12" RESILIENT WEDGE VALVES
Available End Connections

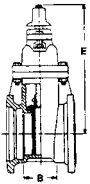

Mechanical Joint
2" - 12"

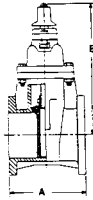

Flanged
2" - 12"

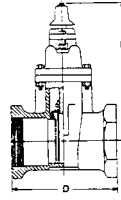

Thread Ends
2" - 3"

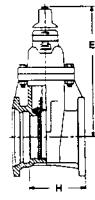

Flgd. & Mech. Jt.
3" - 12"

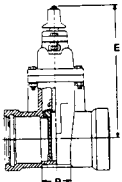

Push-On for
SDR PVC
2" - 8"

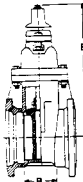

Mechanical
Cutting in Joint
4" - 12"

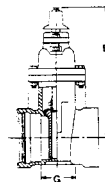

Push-On Ends
for Ductile Iron
and C900 PVC Pipe
4" - 12"

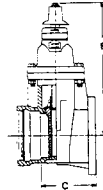

Flanged & Push-On
4" - 12"

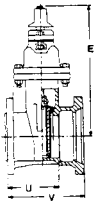

Mech. Jt. for Tapping
4" - 12"

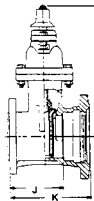

Push-On For Tapping
4" - 8"

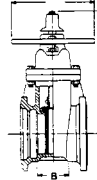

Mechanical Joint
Indicator Post Valve
2" - 12"

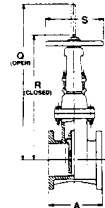

Flgd. OS&Y
Construction
2 1/2" - 12"

DIMENSIONS - INCHES

SIZE INCHES	A	B	C	D	E	G	H	J	K	P	Q	R	S	U	V	TURNS TO OPEN
2	7	3-1/4	-	5-1/4	10-7/8	-	-	-	-	3	-	-	7-1/4	-	-	4-3/4
2-1/2	7-1/2	-	-	7	11-3/8	-	-	-	-	3-1/4	16-3/8	13-7/8	7-1/4	-	-	5-1/2
3	8	3-1/2	-	7-1/8	12-3/8	-	5-3/4	-	-	3-1/2	18-7/8	15-5/8	10	-	-	10
4	9	4-1/2	6-3/4	-	14-3/4	4-1/2	6-3/4	6-3/4	10-3/8	4-1/2	22-3/4	18-1/4	10	6-3/4	9-3/4	13-1/2
6	10-1/2	5	7-7/8	-	19	5-1/4	7-3/4	8-1/4	12	5	30-1/8	23-3/4	12	7-3/4	11-1/4	19-1/2
8	11-1/2	5-1/2	8-1/2	-	22-1/2	5-5/8	8-1/2	8-1/2	12-3/4	5-1/2	37-3/4	29-1/4	14	8-1/2	11-3/4	25-1/2
10	13	7	10	-	26-1/2	7	10	-	-	-	45-3/4	35-3/8	18	10	13-1/2	31-1/2
12	14	8	11-1/4	-	30	8-1/2	11	-	-	-	53-1/8	40-3/8	18	11	14-3/4	37-3/4

CLOW / KENNEDY / M&H 14"-24" RESILIENT WEDGE VALVES

Available End Connections

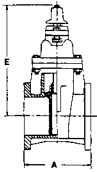

Flanged
14" - 24"

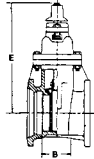

Mechanical Joint
14" - 24"

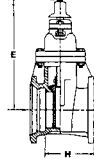

Flgd. & Mech. Jt.
14" - 24"

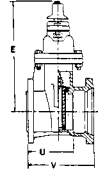

Mech. Jt. for Tapping
14" - 24"

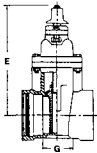

Push-On Ends
for Ductile Iron and
C900 PVC Pipe
16"

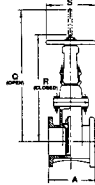

Flgd. OS & Y
Construction
14" - 24"

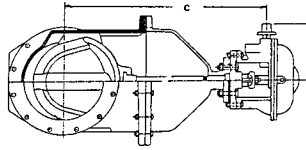

All End Styles
Bevel Gearing
Horizontal Installation

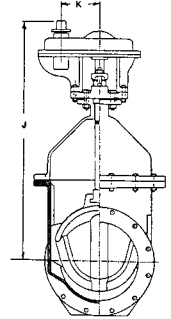

All End Styles
Spur Gearing
Vertical Installation

DIMENSIONS - INCHES

SIZE INCHES	A	B	C	D	E	G	H	J	K	Q	R	S	U	V	TURNS TO OPEN	TURNS W/ GEARING
14	15	10	41-1/2	12	37-1/2	-	13-1/2	50	8	74-3/4	59-3/4	22	13-1/4	16-3/4	52	Spur 3x
16	16	10	41-1/2	12	37-1/2	10-1/2	13	50	8	74-3/4	59-3/4	22	12-3/4	16-1/4	52	
18	17	11-3/4	47-3/4	12	-	-	14-7/8	56-1/4	8	89-5/8	70-5/8	26	14-5/8	18-1/8	64	Bevel 2x
20	18	11	47-3/4	12	-	-	14-1/2	56-1/4	8	89-5/8	70-5/8	26	14-1/2	18	64	
24	20	12	50-1/2	12	-	-	17	59	8	104-3/8	79-3/8	30	17	20-1/2	76	

**CLOW / KENNEDY / M&H UNDERWRITERS AND FACTORY MUTUAL
RESILIENT WEDGE VALVES**



Flanged Ends



Mechanical Joint Ends



Flanged OS&Y

WORKING PRESSURE		HYDROSTATIC TEST PRESSURE	
2" - 12"	200 PSI NON-SHOCK COLD WATER	2" - 12"	400 PSI SHELL

NRS-Flanged & Mechanical Joint

Push-On ends for SDR & C900 PVC Pipe & Ductile Iron Pipe

Flanged OS&Y

Resilient Wedge (R/W) Valves are listed by the Underwriters Laboratories, Inc. and Associated Factory Mutual Companies for use in industrial fire lines. They provide bubble-tight closure at full rated pressure and also provide a clear, unobstructed waterway when in the open position. They are manufactured either non-rising stem or with outside screw and yoke.

For identification, each valve is marked with the letters UL & FM cast into the valve, and can be equipped for indicator post use described on page 163.

OS&Y valve stems are notched to trip alarm switches.

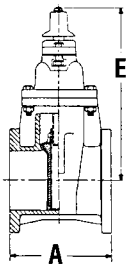

Flanged

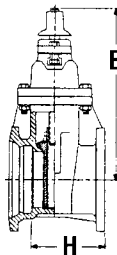

Mechanical Joint & Flanged

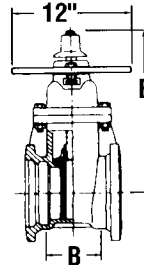

Mechanical Joint Indicator Post Valve Construction

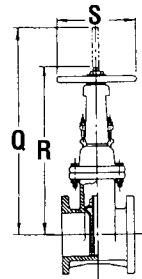

Flanged OS&Y Construction

DIMENSIONS - INCHES

SIZE OF VALVE		2	2-1/2	3	4	6	8	10	12
A	FACE TO FACE OF END FLANGES	7	7-1/2	8	9	10-1/2	11-1/2	13	14
C	DIAMETER OF END FLANGES	6	7	7-1/2	9	11	13-1/2	16	19
E	CENTER OF PORT TO TOP OF NUT, NRS VALVE	12-1/4	12-1/2	13-5/8	15-1/4	19-1/4	23-1/4	26-3/4	30-1/4
G	LAYING LENGTH, MECHANICAL JOINT VALVE	3-1/4	-	3-1/2	4-1/2	5	5-1/2	6	6-1/2
Q	CENTER OF PORT TO END OF STEM, OS&Y OPEN	-	17-5/8	21-7/8	25	32-3/4	41-1/4	48-3/8	55-3/8
R	CENTER OF STEM TO END OF STEM, OS&Y CLOSED	-	14-1/2	18-5/8	20-3/4	26-1/2	32-7/8	38	43
S	DIAMETER OF HANDWHEEL	7-1/4	7-1/4	10	10	12	14	18	18

Flanges are faced and drilled to ANSI B16.1 125 point template, unless otherwise instructed.

RECOMMENDED SPECIFICATIONS FOR RESILIENT WEDGE GATE VALVES CLOW / KENNEDY / M&H

The valve shall conform to the latest revision of AWWA Resilient Seated Gate Valve Standard C509 and be UL listed, FM approved.

All internal parts shall be accessible without removing the body from the line.

The wedge shall be cast iron, completely encapsulated with resilient material. The resilient sealing material shall be permanently bonded to the cast iron wedge with a rubber tearing bond to meet ASTM D429.

NRS stems shall be cast bronze with integral collars in compliance with AWWA. OS&Y stems shall be bronze. The NRS stuffing box shall have two O-Ring seals above the thrust collar and one below. The top two O-Rings shall be field replaceable without removing the valve from service.

There shall be low friction thrust bearings above and below the stem collar. The stem nut shall be independent of the wedge and of solid bronze. The waterway in the seat area shall be smooth, unobstructed, free of cavities and for valves 4" and larger at least 0.19" greater in diameter than the normal valve size.

The body and bonnet shall be coated both interior and exterior with a fusion bonded heat cured thermo setting material meeting all the application and performance requirements of AWWA C550.

The gasket seal between two surfaces shall employ the use of o-ring type gaskets retained to prevent the possibility of blow out.

Each valve shall be hydrostatically tested to the requirements of both AWWA and UL/FM and be rated for 250 psi AWWA service 2"-12" & 200 PSI 14"-24".



M&H AWWA C500 METROPOLITAN GATE VALVES

- NRS-STYLE 1067

- SIDE WEDGE TYPE, IRON BODY
- BRONZE MOUNTED, DOUBLE DISC

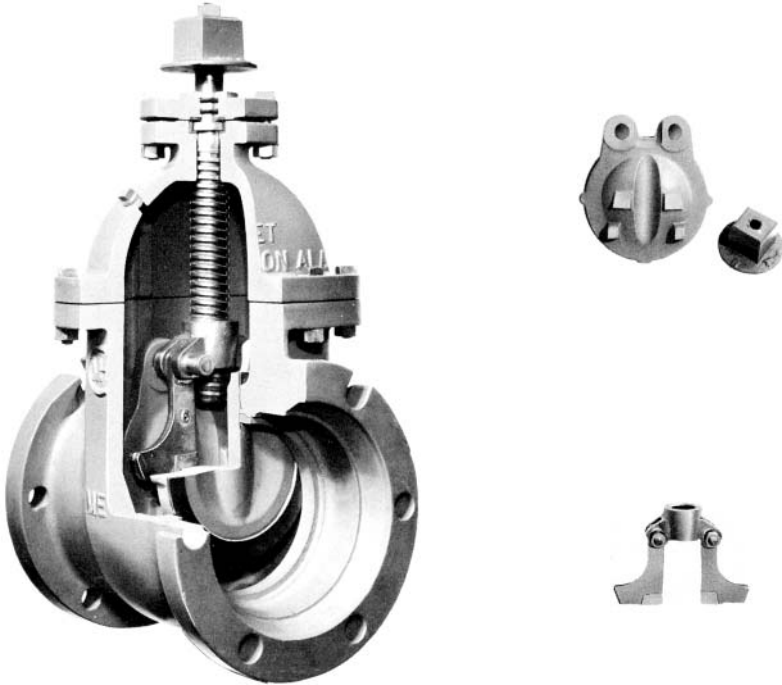

The M&H Metropolitan Gate Valve is a rugged valve whose construction and materials meet AWWA C500 Standards requirements. It is of the side wedge design vs. the more common bottom wedge gate valve.

It is designed for water service and meets standard AWWA test requirements. It is double disc, parallel seat design. Each valve disc on the interior face has surfaces which taper outward. The wedges which act between the two discs have tapered sides which contact the tapers on the discs. The heel of the wedge is tapered and activates the wedging action when it comes in contact with inclines which are cast on each side of the valve body. In operation, the discs are moved laterally away from the seats before the upward opening motion starts. In closing the lateral motion of the wedge takes place after the discs complete the downward travel. This side wedge feature not only makes for easy operation but also reduces friction and wear between gate and seat rings.

In addition, 20" valves which are installed horizontally in a horizontal line have a bronze guide rail. This rail carries the upper wedge during travel and prevents pre-wedging due to the natural weight of wedges in large valves.

M&H Metropolitan Gate Valves can be coated with AWWA C550 coating as an option. Thrust collar glands are bronze on all standard production valves. They are available in tapping configuration in sizes 3" thru 12" and 20".

**SUGGESTED SPECIFICATIONS FOR:
M&H AWWA METROPOLITAN GATE VALVES**

- **STYLES 1067-NRS**
- **SIZES 3"-12" & 20"**
- **WATER SERVICE**

GENERAL

Gate valves shall be of the double disc parallel seat, iron body, bronze mounted, side wedge type. They shall comply with the American Water Works Association Gate Valve Standard C500 as latest revised.

RATING

Gate valves shall be rated at 200 psi water working pressure with 400 psi hydrostatic test for structural soundness for 2" through 12" and 150 psi water working pressure with 300 psi hydrostatic test for structural soundness in 20" size. Testing shall be conducted in accordance with AWWA C500.

END CONFIGURATIONS

Gate valves shall be furnished with type of end connection specified as follows: 125# ANSI B 16.1 flange drilling, mechanical joint per AWWA C111 with (without) accessories.

MATERIALS

All D.I. shall conform to A536 Gr. 65-45-12. Castings shall be clean and sound without defects that will impair their service. No plugging or welding of such defects will be allowed.

Stems shall be manganese bronze having a minimum tensile strength of 60,000 psi, a minimum yield of 20,000 psi for 20" valve.

Bolts shall be electro-zinc plated steel with hex heads and hex nuts in accordance with ASTM A307 and A563, respectively.

DESIGN

Gate valves shall be of the non-rising stem type (NRS) meeting all of the applicable requirements of AWWA C500.

NRS valves shall be furnished with O-ring stem seals using two O-rings located above the stem collar. On all valves O-rings shall be set in the seal plate.

Disc for valve sizes 2" through 4" shall be bronze; for sizes 6" and larger, they shall be cast iron, bronze faced. Bronze facing shall be machined after insertion into disc face.

Disc spreaders for valves 2" through 8" shall be bronze. Spreaders in valves 10" through 20" shall be cast iron, bronze faced. Disc spreader pockets for 20" valves shall be bronze lined. Spreaders shall actuate from the stem nut independent of the bottom of the valve body.

For 20" valves, gearing and by-pass valves are recommended.

Bronze rollers, tracks and scrapers shall be furnished on 20" valves intended for horizontal installation in horizontal line. Additionally, an upper guide rail will be supplied for all valves installed in a horizontal position.

Direction to open shall be counter-clockwise unless otherwise specified.

PAINTING

The inside and outside of all valves, together with the working parts except bronze and machined faces, shall be coated in accordance with AWWA standards.

MARKING

Marking shall be in accordance with AWWA C500 standards, to include name of manufacturer, the year of manufacture, maximum working pressure and size of valve.

CLOW / KENNEDY / M&H AWWA DOUBLE DISC GATE VALVES

Iron Body, Bronze Mounted, Parallel Seat

PRESSURE RATINGS

VALVE SIZE INCHES	WORKING PRESSURE PSI NON-SHOCK COLD WATER	HYDROSTATIC TEST PRESSURE
2 THRU 12	200	400
14 THRU 48	150	300

DESCRIPTION AND ADVANTAGES

AWWA Double Disc Gate Valves are designed primarily for flow control of water in underground pipe lines. They equal or exceed the requirements established by AWWA C500 Standard published by the American Water Works Association and conform to Federal Specifications WW-V-58b, Type II, Class I.

AWWA Double Disc Gate Valves are specifically designed for heavy pressure service.

Neck, flanges, and bell are made extra heavy to withstand pipe strain and possible shifting. Body, cover, gates, and stem are built for extra strength, with clean and simple internal construction, to assure long service and low maintenance.

All working parts are standardized and interchangeable.

OPERATION

Turning the stem releases the wedging pressure on the gates allowing them to move away from their seats before starting upward travel. Further turning of the stem raises the gates into the fully opened position.

When closing the valve, the gates move freely downward without friction, to a position

opposite their seats.

As the gates approach the bottom of the valve, the iron hooks come into contact with stops which prevent further downward movement of the hooks. The bronze wedges riding on these hooks spread the gates apart and force them against their seats.

CONSTRUCTION

Body: Cast Iron, bronze mounted. Sturdy proportions provide protection against damage.

Stem: Manganese bronze of high tensile and torsional strength, with accurate, perfectly machined threads.

Stem Nut: Solid bronze. Independent of hooks, gates, and wedges. Stem or stem nut will not bind or spring out of line, as can happen when stem nut is attached to wedges.

Wedges: Independent, solid bronze. 2-inch thru 3-inch valves have integral hook and wedge. 4-inch thru 8-inch have independent solid bronze wedges placed loosely in iron hooks.

In 10-inch and larger valves, each wedge has one long and one short surface. The long side is used in closing the valve and the short side in opening it.

Low Torque Thrust Bearing: Valves 4" through 12" are fitted with an exclusive Low Torque Thrust Bearing below the stem collar. This bearing reduces operating torque up to 50%, yet seals perfectly for repacking under pressure.

Gates and Gate Rings: Gates 3-inch and smaller are bronze. Gates 4-inch and larger are high strength cast iron with bronze gate rings rolled into machined and dovetailed grooves under pressure to make gate and ring one inseparable unit.

arable unit.

Case Rings: Bronze case rings are screwed into place and machined. They can be removed and replaced if necessary.

Packing: O-Ring packing is standard on all non-rising stem gate valves. Rising stem and geared valves are furnished with conventional packing.

Operating Nut and Handwheel: All valves except flanged valves and outside screw and yoke valves are supplied with 2-inch square operating nuts of high strength cast iron. Flanged valves and outside screw and yoke valves are supplied with handwheels of high strength cast iron.

Yoke: Yokes for outside screw and yoke valves are of rugged cast iron. Careful machining assures accurate stem alignment.

Accessories: Valves can be fitted with any of a large number of accessories, see pages 157 and 158.

Rollers, Tracks and Scrapers: Recommended for 14" and larger diameter valves to carry weight of the gates for valves installed in a horizontal line in horizontal position.

NOTE: All valves open to the left (counter-clockwise) unless otherwise specified.

CLOW / KENNEDY / M&H AWWA DOUBLE DISC NRS GATE VALVES

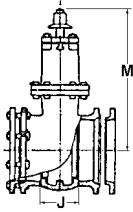

Mechanical Joint

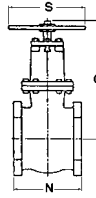

Threaded Ends

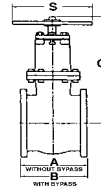

Flanged Ends

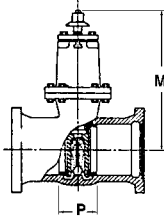

Push-On Ends
For SDR PVC Pipe

Dimension M,
center of port to top of nut,
O-Ring Packing also apply to
Tapping Valves, Cutting-in
Valves and Auxiliary Valves.

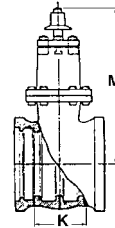

Push-On Ends
For Ductile Iron or
C900 PVC Pipe

DIMENSIONS - INCHES

VALVE SIZE INCHES	TURNS TO OPEN	DIAM. OF STEM	A	B	G	H	J	K	M	N	P	S
2	5	7/8	7	-	10-1/4	3-1/8	3-1/4	-	10-1/4	5-1/4	3	7-1/4
2-1/4	5	7/8	-	-	10-1/4	-	3-1/4	-	10-1/4	-	-	7-1/4
2-1/2	6	7/8	7-1/2	-	11-3/8	-	-	-	11-3/8	5-3/4	3-7/8	7-1/4
3	7	7/8	8	-	12-1/4	4-5/8	3-1/2	-	12-1/4	6	3-1/8	7-1/4
4	15	1-1/8	9	-	14	5-3/4	4-3/4	5-1/4	14	9	4-1/2	10
6	21	1-1/4	10-1/2	-	18	7-7/8	5-1/4	6-1/2	18	-	5-1/4	12
8	27	1-3/8	11-1/2	-	22	10	6-1/2	7	22	-	6-1/4	14
10	33	1-1/2	13	-	25-5/8	12-1/8	6-3/4	7-1/4	25-5/8	-	6-1/2	18
12	39	1-1/2	14	-	29-1/8	14-1/4	7	7-3/4	29-1/8	-	-	18
14	45	1-7/8	15-3/4	23	36-1/2	16-3/8	7-1/4	-	39-3/4	-	-	22
16	52	1-7/8	17	23	40-3/4	18-3/4	9-1/4	-	43-1/2	-	-	22
18	58	2-1/8	19	24	43-1/4	20-3/4	9-1/4	-	46	-	-	26
20	64	2-1/8	20	24	47-1/4	23	10	-	50	-	-	26
24	76	2-1/2	23	28-1/2	55	27-3/8	16	-	56-3/4	-	-	30
30	63	2-3/4	25	32-1/2	64-3/4	33-3/4	12-1/2	-	66-1/2	-	-	30
36	75	3	27	36	75-3/8	40-1/2	23-3/4	-	77-3/8	-	-	36
42	88	3-1/2	34	34	-	46-1/2	-	-	-	-	-	30
48	100	4	45-1/2	45-1/2	-	52-7/8	-	-	-	-	-	30

Turns to open are for valves without gearing.

CLOW / KENNEDY / M&H AWWA DOUBLE DISC GATE VALVES

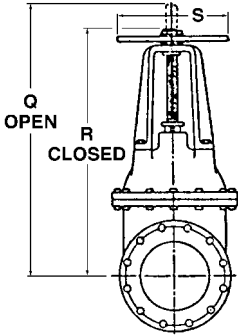

Flanged Ends
Outside Screw & Yoke

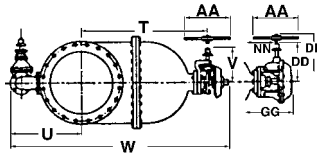

Flanged Ends, NRS
Bevel gearing, by-pass

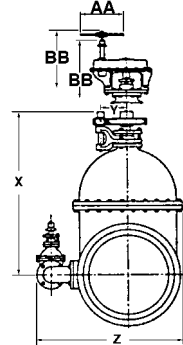

Mechanical Joint, NRS
Spur gearing, by-pass

DIMENSIONS - INCHES

VALVE SIZE INCHES	Q	R	S	T	U	V	W	X	Y	Z	AA	BB	DD	GG	HH
2	13-1/4	10-7/8	7-1/4	-	-	-	-	-	-	-	-	-	-	-	-
2-1/4	-	-	7-1/4	-	-	-	-	-	-	-	-	-	-	-	-
2-1/2	15-1/2	12-1/2	7-1/4	-	-	-	-	-	-	-	-	-	-	-	-
3	18-5/8	15-1/4	7-1/4	-	-	-	-	-	-	-	-	-	-	-	-
4	24	19-3/4	10	-	-	-	-	-	-	-	-	-	-	-	-
5	27-1/4	21-3/4	10	-	-	-	-	-	-	-	-	-	-	-	-
6	31-1/2	24-3/4	12	-	-	-	-	-	-	-	-	-	-	-	-
8	40-1/2	31-1/2	14	-	-	-	-	-	-	-	-	-	-	-	-
10	47-1/4	36-1/4	18	-	-	-	-	-	-	-	-	-	-	-	-
12	58-3/8	45-3/8	18	27-7/8	-	13	-	36-5/8	8	-	18	40-3/4	13	38-1/2	31-5/8
14	68	53	22	33	19-1/4	13	57-1/2	41	8	31-1/8	18	45	13	42-3/4	35-7/8
16	75-3/4	58-3/4	22	36-7/8	20-1/2	13	62-7/8	45	8	33-3/8	18	49	13	46-3/8	39-3/4
18	82-1/2	63-1/2	26	39-7/8	22-1/2	13	67-3/4	48	8	36-3/8	18	52-1/8	13	50	42-7/8
20	90-1/4	69-1/4	26	43-3/4	24	13	73	51-3/4	8	40-1/2	18	55-3/4	13	53-5/8	46-1/2
24	107	82	30	50-1/2	28	13	83-1/2	58-5/8	8	46	18	62-1/8	13	60	52-7/8
30	128-1/4	97	30	62-1/4	31-1/2	17-1/2	100-1/4	71-1/4	10	54-1/2	18	76-3/4	15-1/2	72-1/4	66
36	147-1/2	110	36	74-1/4	40	23-3/4	122-5/8	88-3/4	13-5/8	68-1/8	22	88-5/8	21-1/2	85-3/8	76
42	-	-	30	92	47	17-1/8	145-1/8	102-3/4	10	77-1/2	30	106-3/8	27	105-1/2	97
48	-	-	30	105-7/8	54-1/2	18-7/16	166	116-5/8	11-1/4	87-1/2	30	120-5/8	27	119	108

Flanges are faced and drilled to ANSI 125 pound template, unless otherwise instructed.

CLOW / KENNEDY / M&H TAPPING VALVES FOR CAST IRON, C900 AND PVC

Tapping valves are first bolted to the tapping sleeve and the tapping machine is then bolted to the valve. The valves are designed so that when fully open, the tapping machine cutters can pass through the valve and to the pipe being tapped. Tapping valves can be either the Resilient Wedge Valve or the Double Disc, Parallel Seat style. Valve outlets are available in several types:

- Standardized Mechanical Joint

- Push-On joint for use with Ductile Iron or C900 PVC pipe
- Push-On joint for use with SDR PVC pipe
- RW Valves accept full size cutter

Tapping Valves conform to all applicable provisions of AWWA C500 Standard and Federal Specification WW-V-58b for Type II, Class I Valves or C509.

DOUBLE DISC - PARALLEL SEAT TAPPING VALVES

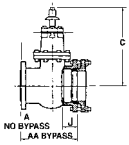

Mechanical Joint Tapping Valve

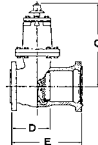

PVC Push-On Joint for PVC Pipe
With same O.D. as Steel Pipe

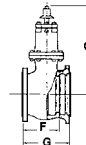

Push-on Joint Ductile Iron Pipe or PVC Pipe with the Same O.D. as Ductile Iron Pipe

PRESSURE RATINGS

	VALVE SIZE INCHES	WORKING PRESSURE PSI NON-SHOCK COLD WATER	HYDROSTATIC TEST PRESSURE PSI
Double Disc	2 THRU 12	200	400
	14 THRU 24	150	300
Resilient Wedge	2 THRU 12	250	500
	14 THRU 24	200	400



RESILIENT WEDGE TAPPING VALVES C509

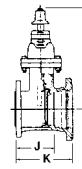

Mech. Jt. For Tapping 4"-24"

Push-On For Tapping 4"-8"

DIMENSIONS - INCHES

NOMINAL SIZE	A*	AA**	C	D	E	F	G	H	J	K	U	V	TURNS TO OPEN			
													DOUBLE DISC	R/W RESILIENT WEDGE		
2	7-3/4	-	10-1/4	-	-	-	-	-	-	-	-	-	-	5	-	
3	9-3/16	-	12-1/4	-	-	-	-	-	-	-	-	-	-	7	-	
4	10-1/4	-	14	6-7/8	11-1/2	6-3/16	10-1/4	14-3/4	6-3/4	10-3/8	6-3/4	9-3/4	11	14-1/2	21	20-1/2
6	11-7/8	-	18	8	13-1/2	7-9/16	11-7/8	19	8-1/4	12	7-3/4	11-1/4	21	26-1/2	27	26-1/2
8	13-1/4	-	22	-	-	8-1/16	14	22-1/2	8-1/2	12-3/4	8-1/2	11-3/4	27	31-1/2	33	31-1/2
10	14-1/4	-	25-1/2	-	-	-	-	26-1/2	-	-	10	13-1/2	33	31-1/2	37	31-1/2
12	16	-	29-1/8	-	-	-	-	30	-	-	11	14-3/4	39	38-3/4	41	38-3/4
14	15/14	23	39-1/4	-	-	-	-	37-1/2	-	-	13-1/4	16-3/4	45	52	47	52
16	20-3/8	23-3/8	43-1/2	-	-	-	-	37-1/2	-	-	13	16-1/4	52	52	54	52
18	19-1/2	24-3/8	46	-	-	-	-	-	-	-	14-5/8	18-1/8	58	64	60	64
20	22-1/8	24-1/8	50	-	-	-	-	-	-	-	14-1/2	18	64	64	64	64
24	25-3/4	28-1/2	56-3/4	-	-	-	-	-	-	-	-	-	76	76	76	76

*Without By Pass

**With By Pass

NOTE: Flange end for bolting to tapping sleeve conforms to MSSSP-60 Standard.

**CLOW / KENNEDY / M&H UNDERWRITERS AND FACTORY MUTUAL
DOUBLE DISC GATE VALVES
4-inch thru 12-inch**



NRS
Mechanical Joint



Flanged NRS



Flanged Ends

WORKING PRESSURE		HYDROSTATIC TEST PRESSURE	
4-10"	200 PSI NON-SHOCK COLD WATER	4-10"	400 PSI SHELL
12"	175 PSI NON-SHOCK COLD WATER	12"	350 PSI SHELL

Underwriters and FM Valves are designed for use in industrial fire protection systems. They are constructed and tested to conform strictly to the specifications and test pressures of the Underwriters Laboratories, Inc., and Associated Factory Mutual Laboratories. Each valve is marked clearly with the letters UL & FM cast into the valve for instant identification. For Indicator Posts and Indicator Post Valves, see page 163.

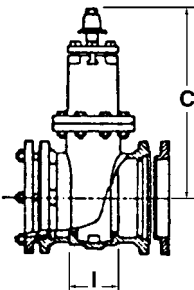

Mechanical Joint
NRS

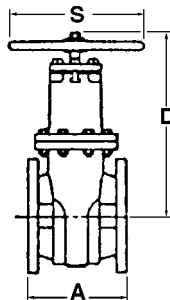

Flanged Ends
NRS

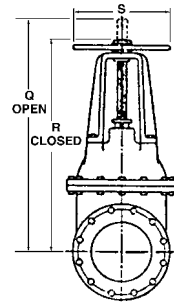

Flanged Ends
OS&Y

DIMENSIONS - WITHOUT GEARING - INCHES

SIZE OF VALVE		4	6	8	10	12
A	FACE TO FACE OF END FLANGES	9	10-1/2	11-1/2	13	14
C	CENTER OF PORT TO TOP OF NUT, O-RING PACKING	14	18	22	25-5/8	29-1/8
D	CENTER OF PORT TO TOP OF HANDWHEEL, O-RING PACKING	14	18	22	25-5/8	29-1/8
I	LAYING LENGTH, MECHANICAL JOINT VALVE	4-3/4	5-1/4	6-1/2	6-3/4	7
Q	CENTER OF PORT TO END OF STEM, OS&Y VALVE OPEN	24	31-1/2	40-1/2	47-1/4	58-3/8
R	CENTER OF PORT TO END OF STEM, OS&Y VALVE CLOSED	19-3/4	24-3/4	31-1/2	36-1/4	45-3/8
S	DIAMETER OF HANDWHEEL	10	12	14	18	18

Flanges are faced and drilled to ANSI B16.1 125 pound template, unless otherwise instructed.

CLOW / KENNEDY / M&H CUTTING-IN VALVES



Mechanical Joint
Cutting Valve
Sizes 4"-12"

Mechanical Joint Cutting-In Valves are AWWA valves of the parallel seat, double disc type used for installing gate valves in existing water lines. The mechanical joint is specially designed so that with one gasket it can be assembled on either sand cast or centrifugally cast iron pipe.

Installation is described below. Construction and parts of this valve are the same as shown on page 148.

Cutting-in valves are used for replacing worn out valves, adding valves for increased zone control, adding auxiliary valves for fire hydrants, and other purposes where valves must be installed in existing mains.

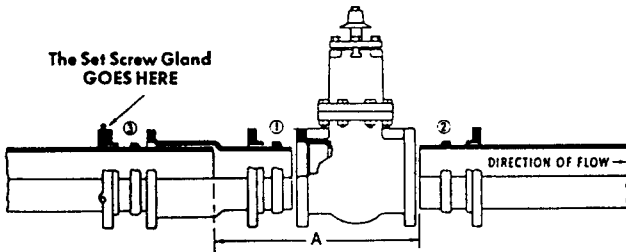

HOW THE VALVE IS INSTALLED

Joints should be installed in 1-2-3 order

1. From the existing line cut out exact length of pipe shown for dimension "A". Remove nuts, bolts, glands and gaskets from bell end joints of gate valve and from large end of sleeve. Slip glands and gaskets over cut ends of pipe and over small end of sleeve. Position sleeve and telescope it over end of the pipe.

2. Lower valve into position between pipe end and spigot end of sleeve. Push valve home and move sleeve along pipe until its spigot is seated in other bell of valve.

3. Tighten nuts gradually. To complete installation, tighten set screws in gland on sleeve against the pipe.

**CLOW / KENNEDY / M&H LIST 16
EXTRA HEAVY PRESSURE GATE VALVES
Iron Body, Bronze Mounted, Double Disc, Parallel Seat**

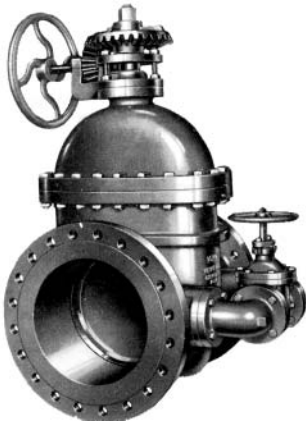

Flanged Ends, Non-rising Stem, with Bevel Gears and By-pass

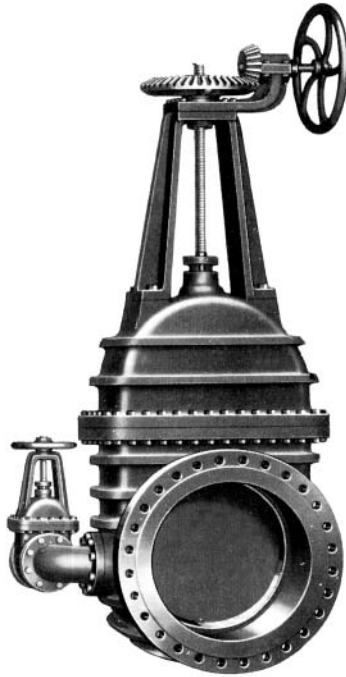

Flanged Ends, Outside Screw and Yoke with Bevel Gears and By-pass

List 16 (Extra Heavy Pressure) Gate Valves exceed the pressure of AWWA specifications. Their construction is extra heavy and ribbed to withstand the greater pressures at which they are intended to operate. Valves are made with flanged ends only. Flanges are regularly furnished Extra Heavy, faced and drilled to ANSI 250 pound template.

Square operating nuts or handwheels can be furnished as required. Direction of opening is indicated by an arrow cast on the operating nut skirt or on the rim of the handwheel.

List 16 valves can be furnished with gearing and/or by-passes; equipped for motor operation; or fitted with any of the accessories on pages 157 and 158.

PRESSURE RATING

VALVE SIZE INCHES	WORKING PRESSURE PSI NON-SHOCK, COLD WATER	HYDROSTATIC TEST PRESSURE PSI
4 THRU 20	250	500
24 AND 30	225	450

**DIMENSIONS OF CLOW / KENNEDY / M&H LIST 16
EXTRA HEAVY PRESSURE GATE VALVES**

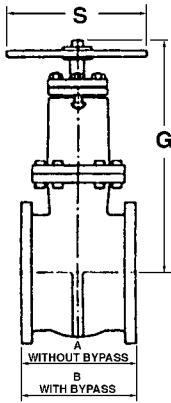

Flanged Ends, NRS

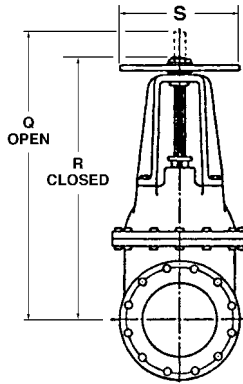

Flanged Ends, OS&Y

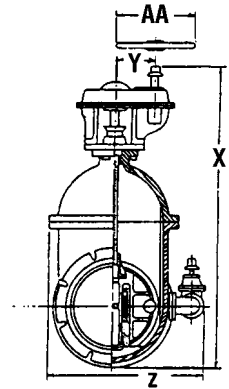

Flange Ends, NRS, with Spur Gears, By-pass

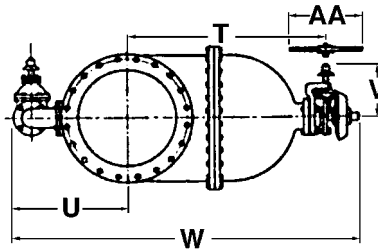

Flanged Ends, NRS, with Bevel Gears, By-pass

SIZE INCHES	A	B	G	Q	R	S	T	U	V	W	X	Y	Z	AA	URNS TO OPEN	DIAM. OF STEM
4	9-5/8	-	14	24	19-3/4	10	-	-	-	-	-	-	-	-	15	1-1/8
6	11-1/2	-	18	32-1/2	25-1/2	12	-	-	-	-	-	-	-	-	21	1-1/4
8	12-1/2	-	22	40-1/2	31-1/2	14	-	-	-	-	-	-	-	-	27	1-3/8
10	14-1/2	-	25-5/8	47-1/4	36-1/4	18	-	-	-	-	-	-	-	-	33	1-1/2
12	17	-	29-1/8	58-3/4	45-3/4	18	27-5/8	-	13	-	36-1/8	8	-	18	39	1-1/2
14	17-1/2	26-1/4	36-1/4	67-3/4	52-3/4	22	33	21	13	58-1/4	41	8	33	18	45	1-7/8
16	19	27-1/2	40-1/4	74-3/4	57-3/4	26	36-7/8	22	13	64	45	8	35-1/4	18	52	2
18	21	27-1/2	43-3/8	82-1/2	63-1/2	26	39-7/8	24	13	69-3/4	48	8	38-1/2	18	58	2-1/8
20	21-1/2	28	48	90-1/4	69-1/4	30	43-3/4	24-3/4	13	74	51-3/4	8	41-1/2	18	64	2-1/4
24	26	34	54-3/8	105	79-3/4	30	52-7/8	29-1/2	17-1/2	89	60-5/8	10	47-1/4	18	51	2-3/4
30	30	34	65-3/8	128-1/4	97	36	64-1/8	33-1/2	23-3/4	105-1/2	79-1/8	13-3/8	57-1/2	22	63	3

Flanges are Extra Heavy faced and drilled to ANSI 250 pound template, unless otherwise instructed. Turns to open are for valves without gearing.

BY-PASS VALVES
for AWWA and List 16 Valves



By-pass
Non-rising Stem

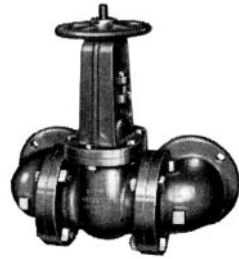

By-pass
Rising Stem, OS&Y

By-pass valves fitted to gate valves make valve operation easier by equalizing the pressure on both sides of the gates. They may be rising stem or non-rising stem type, and are normally the same type as the main valve to which they are fitted, and have the same operating device, hand-wheel or operating nut, as the main valve.

For AWWA and List 16 valves, by-pass valves are furnished in the sizes recommended by the American Water Works Association, as follows:

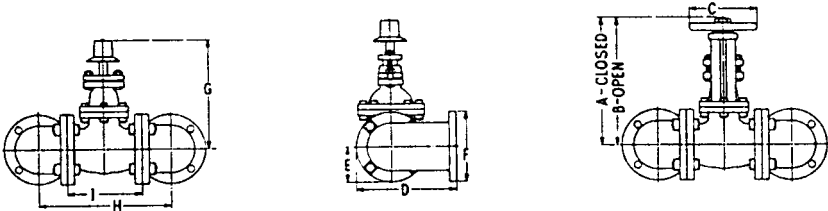

FOR SIZE OF VALVE.....INCHES	14	16	18	20	24	30	36
BY-PASS VALVE, SIZE FOR AWWA AND LIST 16 VALVES.....INCHES	2	3	3	3	4	4	6

SIZE OF BY-PASS INCHES	TYPE OF VALVE BY-PASS USED ON	SIZE OF ELBOWS INCHES	DIMENSIONS - INCHES								
			A	B	C	D	E	F	G	H	I
2	FLANGED	2 X 2	10-7/8	13-1/4	7-1/4	9-1/2	3	6	10-1/4	10-3/4	7
3	FLANGED	3 X 3	15-1/4	18-5/8	7-1/4	9-1/8	3-3/4	7-1/2	12-1/4	12-7/8	8
4	FLANGED	4 X 4	19-3/4	24	10	11	4-1/2	9	14	14-1/4	9
6	FLANGED	6 X 6	24-3/4	31-1/2	12	14-1/8	5-1/2	8-1/8 X 13-1/2	18	17-1/2	10-1/2

Note: By-pass dimensions for 42" and 48" valves on application.

**CLOW / KENNEDY / M&H GEARING, GEAR CASES,
AND POSITION INDICATORS
For Double Disc Gate Valves**



Spur Gears
Non-rising Stem



Bevel Gears
Non-rising



Spur Gears
Outside Screw &
Yoke



Bevel Gears
Outside Screw &
Yoke



Spur Gears
Extended Gear Case



Bevel Gears
Extended Gear Case



Indicator
Barrel Type

Gearing

Cut tooth cast steel gears are normally furnished on AWWA gate valves unless otherwise specified. Cast iron gears are normally furnished on all other valves. However, cut tooth cast steel gears or cast tooth cast iron gears can be furnished on all valves if specified. Pinion shafts are made of rolled bronze.

Extended Gear Cases

Extended gear cases can be furnished for all non-rising stem valves. The case is mounted on distance pieces which hold it above the valve cover and make the valve stuffing box easily accessible. Side plates are furnished to cover stem and stuffing box where required for buried service.

Gear Cases

Gear cases are made of high strength cast iron and designed for easy refilling. The use of gear cases keeps foreign matter out of the gearing and provides easy operation, by keeping the gears lubricated.

Position Indicators

Indicators to show the valve position in non-rising stem gate valves can be furnished for valves in sizes 2 thru 48 inches.

Barrel Type

Barrel type indicators are made of high strength cast iron, with bronze working parts and are of the worm gear type. They are used on valves with bevel or spur gearing. A bronze pointer moves along a bronze plate on which figures indicate valve position.

CLOW / KENNEDY / M&H ROLLERS, TRACKS AND SCRAPERS

*For 14-inch and Larger Diameter Double Disc Gate Valves
Installed Horizontally*

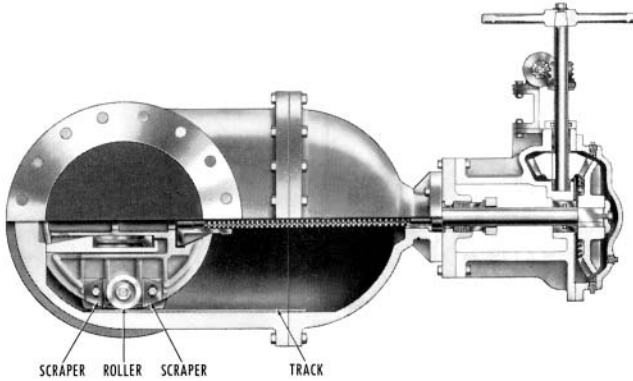

Cutaway view of valve showing rollers, tracks, and scrapers

Valve installed
horizontally in a
vertical pipe line

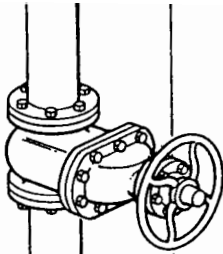

Valve installed
horizontally in a
horizontal
pipe line

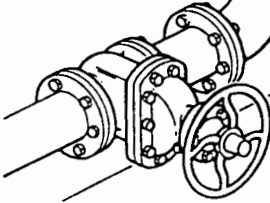

Rollers, Tracks and Scrapers

Valves 14" and larger installed in a horizontal pipe line with their stems horizontal should be equipped with rollers, tracks and scrapers, as illustrated. The rollers assist the travel of the gate assembly along tracks set into the valve body, retaining it in alignment, and promoting ease of operation, not otherwise possible. Scrapers are provided ahead of the rollers to clear the track of obstruction or foreign matter.

When required, rollers, tracks and scrapers are bronze.

**CLOW, KENNEDY AND M&H
ORDERING INFORMATION**

Use Figure Number wherever possible to identify product wanted

When placing orders or making inquiries, please furnish the following information. This information will enable us to answer your questions, prepare quotations, and fill your order promptly. Lack of essential information is almost sure to cause delays.

1. **Quantity.**
2. **Size.**
3. **Working pressure:** Refer to tables of pressure ratings.
4. **End type or types:** Refer to appropriate pages for end types available.
- 4A. **Flanged valves:** Normally furnished with ANSI 125 pound Standard flanges with bolt holes straddling vertical center lines.
- 4B. **Mechanical Joint valves:** Normally furnished with standardized mechanical joints with plain rubber gaskets. Cutting-in type mechanical joints also available for use in existing cast iron pipe lines.
5. **Direction of opening:** Must be specified. Open left (counterclockwise); or open right (clockwise).
6. **Type of stem:** State whether non-rising stem or rising stem with outside screw and yoke.
7. **Installation position:** Indicate position in which valve will be installed (vertically, horizontally, or otherwise).
8. **Operating nut or handwheel:** All flanged valves and all rising stem valves with outside screw and yoke are furnished with handwheels unless otherwise specified. Other valves are furnished with a 2-inch square operating nut unless otherwise specified.
9. **Stuffing box:** Whether conventional or O-Ring. Unless otherwise specified, we regularly furnish NRS valves with O-Ring packing; other valves are regularly furnished with conventional stuffing box packing.
10. **Indicator posts and valves:** State depth of trench (distance from ground line to bottom of the pipe line); size and shape of operating nut, if other than standard. For valves already in place, state whether valve is equipped with a flange for post support; if so, give flange dimensions, and distance from center line of valve to top of flange.
11. **By-pass Valves:** State location, whether manually operated by-pass will have handwheel or operating nut, and any special instructions necessary.
12. **Parts:** Always order parts by number.
13. **Available with motor operator:** State maximum temperature at location of valve control. Closing or opening time in minutes. Electrical characteristics, voltage, phase, control voltage. Controls - starters, transformers, push buttons, lights, selector switch, etc. Open/close or throttling service.

SPECIFICATIONS

AWWA gate valves are manufactured in accordance with American Water Works Association Standard AWWA C500, Gate Valves for Ordinary Water Service, and Federal Specifications WW-V-58b, for Type II, Class I, Valves.

CLOW WILLIAMS - HAGER SILENT CHECK VALVES

Control Surge Pressures and Prevent Water Hammer



F-5390
Style 636 Globe Type



(Class 125 and 250)
F-5394
Style Flat Type

Silent check valves are installed in the discharge side of pumps to provide noiseless operation and prevent water hammer. By closing silently *the instant* flow reaches zero and *before* flow reversal takes place, these valves control dangerous surge pressures and eliminate resulting water hammer.

Clow valves can be furnished for pressures from vacuum to 250 psi ANSI B16.1 Classes 125 and 250 valves have high tensile cast iron body and bronze trim.

DIMENSIONS* - INCHES

VALVE SIZE	FACE TO FACE OF FLANGES		MAXIMUM VALVE O. D.	
	STYLE 636	STYLE 329	STYLE 636	STYLE 329
1	-	2-1/2	-	4-1/4
1-1/4	-	2-1/2	-	4-5/8
1-1/2	-	2-1/2	-	5
2	-	3	-	6
2-1/2	-	3	-	7
3	7-1/2	3	7-1/2	7-1/2
4	8-1/2	4-1/4	9	9
5	9-1/2	4-1/4	10	10
6	11	5	11	11
8	11-1/4	6-1/2	14-3/4	14-3/8
10	12-1/2	-	17-1/4	-
12	18	-	19	-
14	21	-	22-3/8	-
16	22-1/2	-	25-1/8	-
18	24	-	30-1/4	-
20	27	-	34-1/4	-
24	32	-	38-1/2	-
30	29-1/4	-	44-1/2	-

*Dimensions shown are for Class 125 standard. Higher classes may increase slightly.

CLOW ECCENTRIC PLUG VALVES



F-5412
Flanged Eccentric
Plug Valve



F-5413
Mechanical Joint
Eccentric Plug Valve
With worm Gear Operator

Pressure Rating

VALVE SIZE INCHES	WORKING PRESSURE PSI NON-SHOCK COLD WATER	HYDROSTATIC TEST PRESSURE PSI
3-12	0-175	350
14-24	0-150	300

Clow Eccentric Plug Valves are designed to meet the needs of the water and waste water industry, featuring quality construction and performance features including:

- 1. Stem Packing Seals** - Clow utilizes Buna-N multiple “V” ring stem packing seals. This sealing system conforms to AWWA C504 and AWWA C507 standards. The Clow valve is repackable while under pressure without removing the actuation. The packing seal is held in place with an adjustable gland follower to provide many years of reliable service.
- 2. Bolted /Bonnet** - Valve bonnets are fully sealed and securely bolted to the valve body for easy removal of the plug should maintenance be required.
- 3. Shaft Bearings** - Sintered 316 stainless steel shaft bearings are used in the upper and lower trunnions. These bearings are permanently lubricated for ease of operation even after long periods of inactivity.
- 4. Valve Body** - The body and cover of the Clow valve is cast iron (Semi-Steel) conforming to ASTM A126 Class B. Flanged valves are in full compliance with ANSI B16.1 Class 125 standards including flange thickness. Mechanical Joint valves are in compliance with AWWA C111/ANSI 21.11. Grooved End valves are in compliance with AWWA C606.
- 5. Welded Nickel Seat** - Clow welds a corrosion resistant nickel seat to a raised area in the body. The weld is of 90% pure nickel, at least 1/8" thick after it is machined. The nickel covers the entire seat surface so that there is no possibility of corrosion that could damage the plug face.
- 6. Plug** - The valve plug is cast iron ASTM A126, Class B. The portion of the plug in the valve body cavity is coated with Buna-N rubber using an injection molding process. This allows for the entire surface to be covered not just the plug face. With this injection molding process you do not have to worry about the rubber dis-bonding from the iron.
- 7. O-Ring Bonnet Seal** - The seal between the body and bonnet is an O-ring allowing for easier maintenance, and since o-rings seal better than flat gaskets the number of bonnet bolts is reduced.
- 8. Position indicator and Memory Stop** - Clow quarter-turn valves are equipped with a position indicated marked at 10 degree increments and an open position memory stop that can be used for balancing applications.
- 9.** A totally enclosed and sealed manual worm gear operator is available for all valve sizes 4" and larger.
- 10.** Motor, pneumatic and hydraulic operators are available upon application.

CLOW ECCENTRIC PLUG VALVES

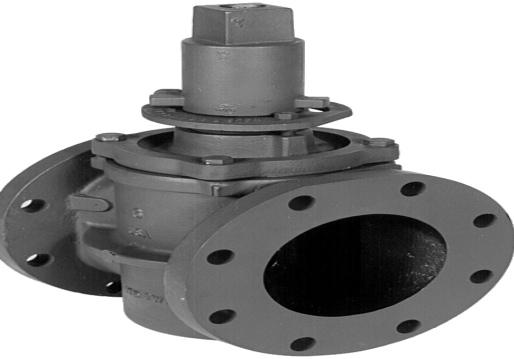

F-5412 Flanged Ends
Eccentric Plug Valve



F-5413 Mechanical Joint Ends
Eccentric Plug Valve

Flanged Ends - Genral Demimions

VALVE SIZE	A	B	C	D	E	F	G	H	J
3"	7-1/2	6	8	3-15/32	16-3/4	11	3/4	4-3/4	0
4"	9	7-1/2	9	4-7/16	11	16-3/8	1	8-3/4	4
6"	11	9	10-1/2	6-1/8	14-1/2	21	1-1/16	8-3/4	2
8"	13-1/2	11-3/4	11-1/2	7-5/8	16	24-1/4	1-1/16	8-3/4	4

SMJ Ends - Genral Demimions

VALVE SIZE	A	B	C	D	E	F	H	K	L
3"	7-5/8	6-3/16	11-7/8	3-15/32	6-3/4	11	4-3/4	6-7/8	2-1/2
4"	9-1/8	7-1/2	12-1/4	4-7/16	11	16-3/8	4-3/4	7-1/4	2-1/2
6"	11-1/8	9-1/2	14-1/8	6-1/8	14-1/2	21	6-3/4	9-1/8	2-1/2
8"	13-3/4	11-3/4	17-1/2	7-5/8	16	24-1/4	6-3/4	12-1/2	2-1/2

Note: Flange Ends are faced and drilled to ANSI 125 lb Template, see page 82 & 83.
Note: Mechanical Joint Ends conform to ANSI/AWWA-C111/A21.1 Standard, see page 50.

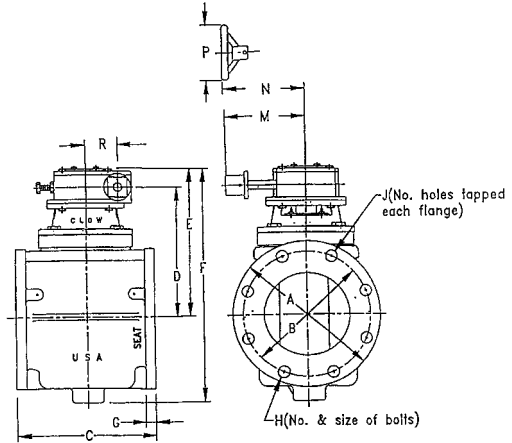

DIMENSION - INCHES

VALVE SIZE	A	B	C	D	E	F	G	H	J	M	N	P	R
4	9	7-1/2	9	9-3/16	11-1/16	16-7/16	1	8-3/4	4	8	11	10"	3-1/4
6	11	9-1/2	10-1/2	10-7/8	12-3/4	19-1/4	1-1/16	8-3/4	2	8	11	10"	3-1/4
8	13-1/2	11-3/4	11-1/2	12-3/8	14-1/4	22-1/2	1-3/16	8-3/4	4	8	11	10"	3-1/4
10	16	14-1/4	13	14-1/2	16-3/8	26-11/16	1-1/4	12-7/8	4	8	11-12	10"-18"	3-1/4
12	19	17	14	16-1/16	17-15/16	30	1-1/4	12-7/8	4	8	11-12	10"-18"	3-1/4
14	21	18-3/4	17	18-7/8	22-1/4	36-9/16	1-3/8	12-7/8	4	10	16	24"	4-3/4
16	23-1/2	21-1/4	17-3/4	20-1/16	23-7/16	39-3/16	1-7/16	16-1	6	12	18	24"	5
18	25	23-3/4	21-1/2	22-1/8	25-1/2	42-11/16	1-9/16	16-1-1/8	8	12	18	24"	5
20	27-1/2	25	23-1/2	23-7/16	26-13/16	46-13/16	1-13/16	20-1-1/8	8	12	18	24"	5
24	32	29-1/2	30	25-1/16	28-7/16	51-3/8	1-7/8	20-1-1/4	8	12	18	24"	5

**UNDERWRITERS AND FACTORY MUTUAL
INDICATOR POSTS
KENNEDY / CLOW**



Vertical
Indicator Post

Indicator Posts are used in industrial fire protection systems or other installations where it is necessary to tell at a glance if the valve is in the open or closed position. Indicator posts can be furnished in the Vertical Type, Wall Type or Fixed Post Type - not shown.

Posts have two large window openings which are fitted with a heavy clear plexiglass as illustrated. Aluminum target plates, with the words OPEN and SHUT cast in large, easy-to-read, raised letters are located directly behind each window in such a position that the appropriate word appears as the valve is operated.

Stem, indicators, and all working parts are fully protected from moisture and weather damage by complete enclosure. Operating nuts 1-1/4 inches square and wrench are furnished for vertical Indicator Posts unless otherwise specified.

When ordering the vertical post, specify (1) quantity and (2) size (B, C, D or F, G, H from the tables below). When ordering Wall Type posts, specify (1) quantity, and (2) thickness of the wall plus the distance from the wall to the valve operating nut skirt.

**TELESCOPING BARREL 2945A
TRENCH DEPTH LIMITS**

VALVE SIZE	SIZE "B"		SIZE "C"		SIZE "D"	
	MIN.	MAX.	MIN.	MAX.	MIN.	MAX.
4"	31	51	48	68	66	86
6"	35	55	53	73	71	91
8"	40	60	58	78	76	96
10"	45	65	63	83	81	101
12"	49	69	67	87	85	105
14"	54	74	72	92	90	110

Other Trench depths available on special order.

**FIXED LENGTH POSTS 2945
MAXIMUM TRENCH DEPTH**

VALVE SIZE	SIZE "F"	SIZE "G"	SIZE "H"
4"	45-1/2	63-1/2	87-1/2
6"	49-1/2	67-1/2	91-1/2
8"	54-1/2	72-1/2	96-1/2
10"	59	77	101
12"	64	82	106
14"	69	87	111

Other trench depths available on special order.

UL/FM INDICATOR POST VALVES

Indicator post valves are of the same construction as other UL/FM valves except they are fitted with a 12-inch diameter bonnet flange onto which the Indicator Post bolts. When ordering, specify type of valve and end configuration.

PARALLEL SEAT DOUBLE DISC VALVES



Wall Type
Indicator Post

Flanged Ends
Mechanical Joint

Flanged and Mechanical Joint

RESILIENT WEDGE VALVES

Flanged Ends
Mechanical Joint

Flanged & Mechanical Joint

FLANGED BASE POST INDICATOR

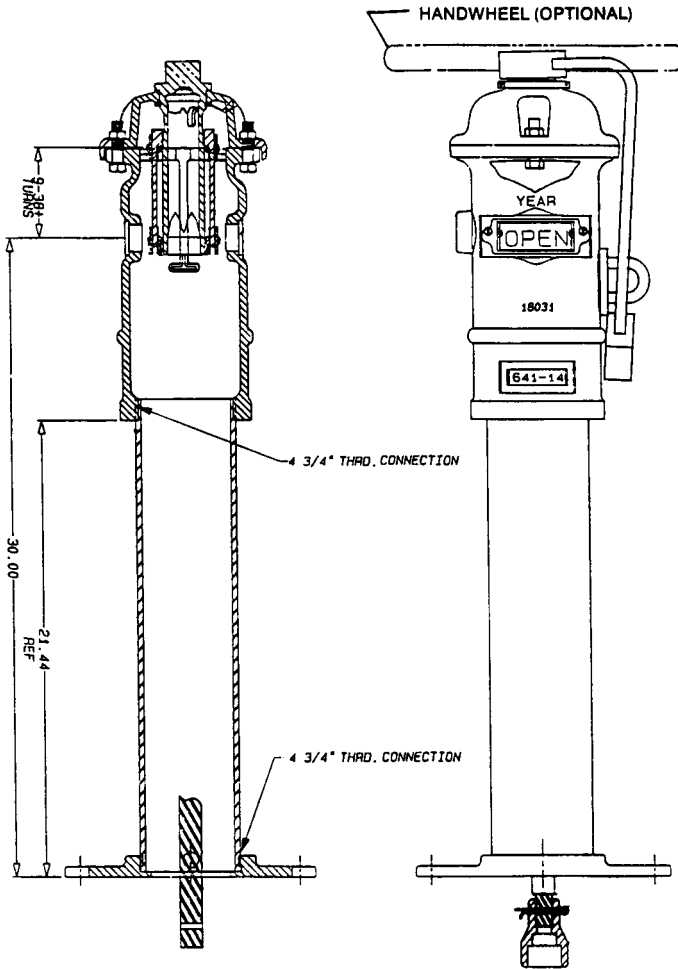

The Kennedy / Clow Flanged Base Indicator Post is specially designed to be mounted on a vault / pit cover. This non-adjustable post can be supplied with optional couplings for either non-rising stem or outside screw and yoke valves.

**UNDERWRITERS AND FACTORY MUTUAL
INDICATOR POSTS AND VALVES
KENNEDY / CLOW
WALL POSTS**

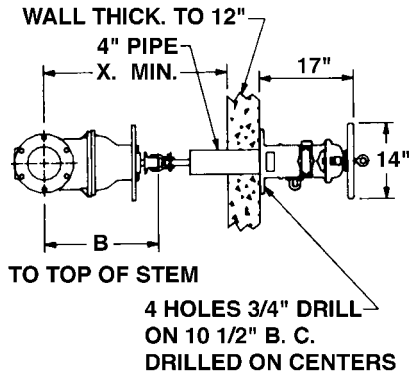

Dimensions Figure 64113
To order, supply Dimensions X & B

SIZE	4"	6"	8"	10"	12"	14"
X(Min.)	12.00"	15.62"	19.25"	23.12"	26.00"	30.12"

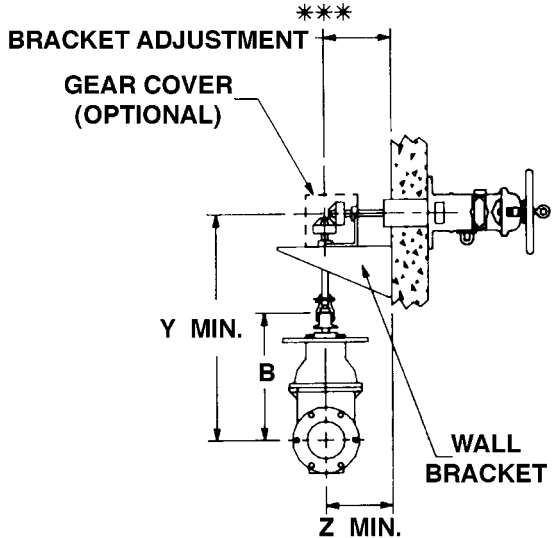

Dimensions Figure 551
To order, supply Dimensions B, Y, Z.

SIZE	4	6	8	10	12	14
Y(Min.)	25.00"	29.00"	32.50"	36.00"	40.37"	43.37"
Z(Min.)	7.00"	7.00"	8.37"	9.37"	10.50"	12.00"

*** Style "A" 6"-15" - Two 18" Stems
"B" 15"-24" - Two 24" Stems

**INDICATOR POST
TELESCOPING BARREL UL/FM
KENNEDY / CLOW**

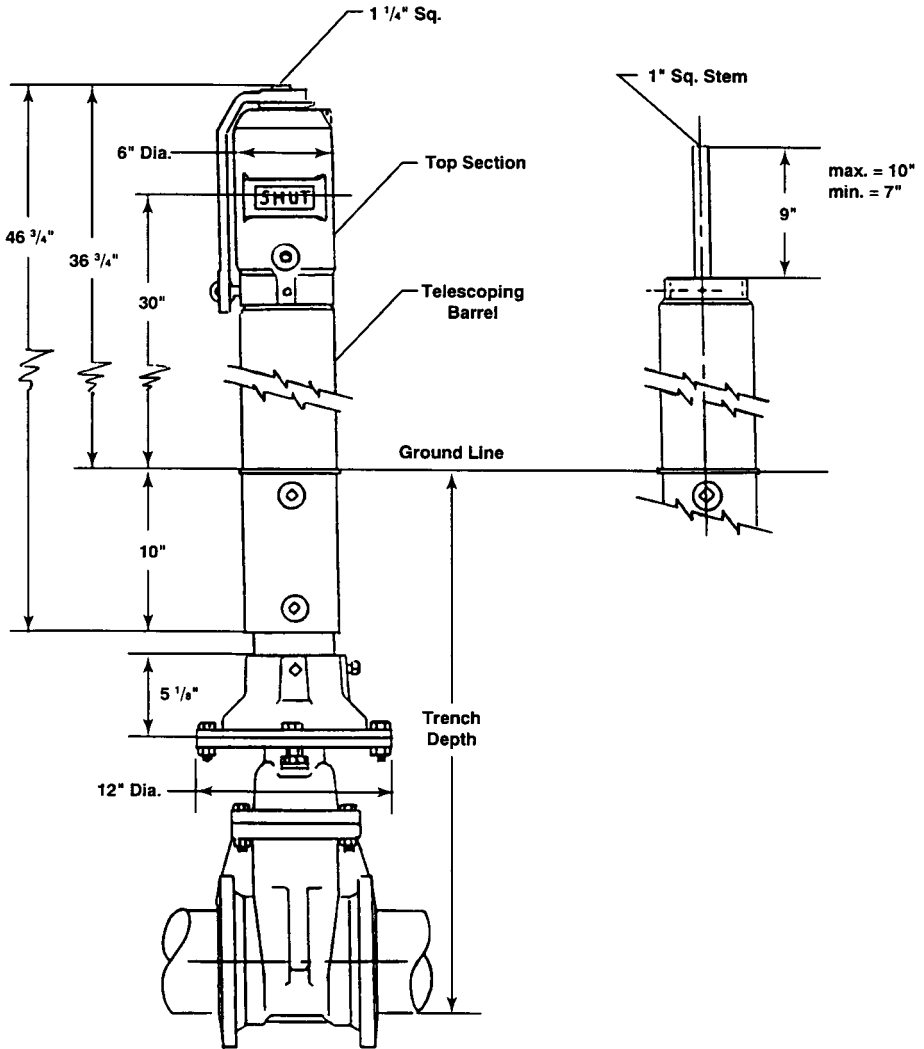

Available in Sizes B, C, D
See Page 168 for Dimensions

FIELD ADJUSTMENT INSTRUCTIONS

1. Remove the top section from the top of the Indicator Post Assembly.
2. Loosen the telescoping barrel screws and adjust barrel to the ground line.
3. Cut the 1" Sq. stem at a distance of 9" above the top of the barrel end.
4. Set the "OPEN" and "SHUT" targets for the appropriate valve size.
5. Reattach the top section to the top of the Indicator Post assembly.

**INDICATOR POST STYLE 2945
FIXED LENGTH UL / FM
KENNEDY / CLOW**
Dimensions And Instructions

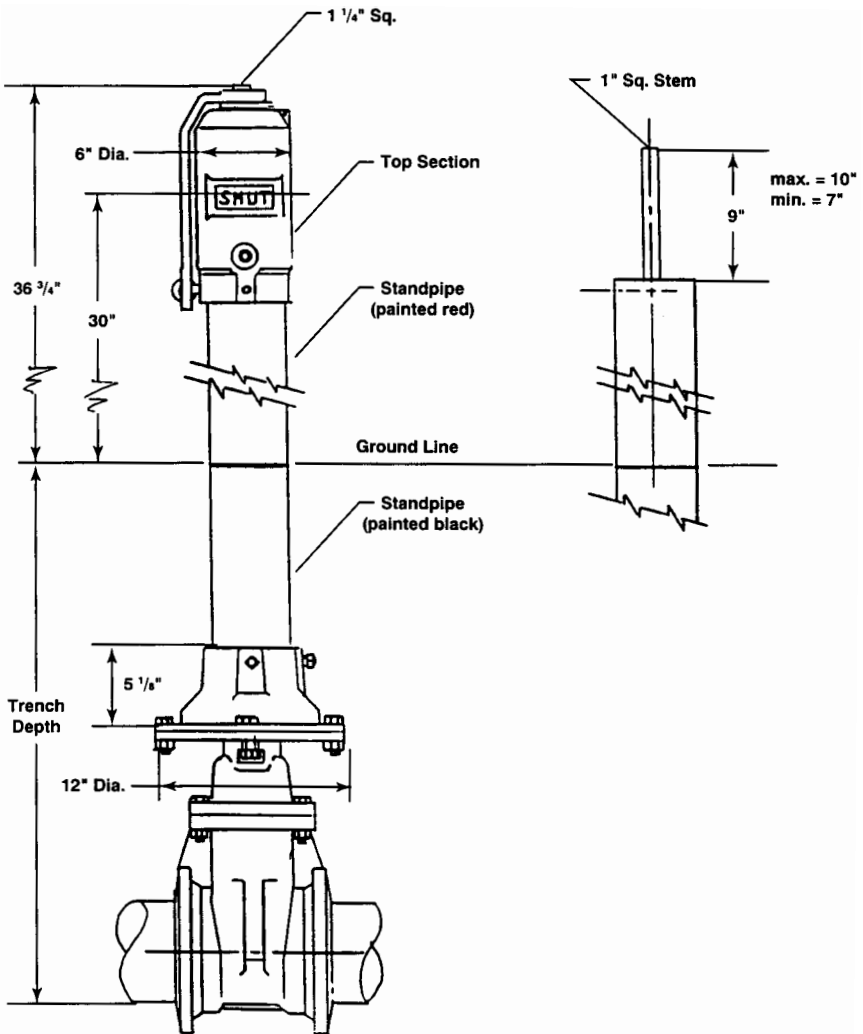

Available in Sizes F, G, H
See Page 168 for Dimensions

FIELD ADJUSTMENT INSTRUCTIONS

1. Remove the top section from the top of the Indicator Post Assembly.
2. Cut the required length off the bottom of the Standpipe for the Ground Line to match up with Standpipe Ground Line mark.
3. Cut the 1" Sq. Stem at a distance of 9" above the top of the Standpipe.
4. Set the "OPEN" and "SHUT" targets for the appropriate valve size.
5. Reattach the Top Section to the top of the Indicator Post assembly.

KENNEDY / CLOW INDICATOR POST TRENCH DEPTHS FOR GATE VALVES *UL & FM APPROVED*

TELESCOPING BARREL TRENCH DEPTH LIMITS

VALVE SIZE	B SIZE		C SIZE		D SIZE	
	MIN.	MAX.	MIN.	MAX.	MIN.	MAX.
4"	31"	51"	48"	68"	66"	86"
6"	35"	55"	53"	73"	71"	91"
8"	40"	60"	58"	78"	76"	96"
10"	45"	65"	63"	83"	81"	101"
12"	49"	69"	67"	87"	85"	105"
14"	54"	74"	72"	92"	90"	110"

FIXED LENGTH POSTS MAXIMUM TRENCH DEPTH

VALVE SIZE	F SIZE	G SIZE	H SIZE
4"	45-1/2"	63-1/2"	87-1/2"
6"	49-1/2"	67-1/2"	91-1/2"
8"	54-1/2"	72-1/2"	96-1/2"
10"	59"	77"	101"
12"	64"	82"	106"
14"	69"	87"	111"

SAMPLE GATE VALVE SPECIFICATION *DOUBLE DISC*

Gate Valves:

Valves shall be manufactured in accordance with AWWA Standard C500-80. Valves 12" and smaller shall be designed for 200 psi water working pressure and 150 psi for valves 14" - 48" inclusive. Valves shall have _____ (Bell, M/J, Flanged or as indicated on plans) ends and shall have clear waterway equal to the full nominal diameter of the valve. Valves shall be double disc parallel seat type with _____ (non-rising, rising) stems, opening by turning _____ (left, right) and provided with _____ (2" square nuts, handwheel) with arrow cast in metal to indicate direction of opening.

Each valve shall have maker's name, pressure rating and year in which manufactured cast on body. Prior to shipment from the factory each valve shall be tested by hydrostatic pressure equal to 400 psi in sizes 12" and smaller and 300 psi in sizes 14" and larger.

**INDICATOR POST
PRODUCT DATA SHEET**

Installation - The valve should be opened to the fully open position before proceeding with the Indicator Post Installation.

1. Disassembly of the Indicator Post Unit:

Telescoping Barrel Units

- Remove the top section from the end of the telescoping pipe section.
- Loosen the two screws on the telescoping pipe section and slide it off the top of the lower pipe.

Fixed Length Units

- Remove the top section from the end of the standpipe.

2. Base Flange Installation:

- Attach the base flange along with the lower standpipe to the valve plate using the 5/8" bolts and nuts provided.

3. Grade Line Adjustments:

Telescoping Barrel Units

- Lower the pipe telescoping section over the lower standpipe until the grade line mark on the barrel is at ground line height and then tighten the two screws securely.

Fixed Length Units

- Cut the required length off the bottom of the standpipe so that the indicated grade line of the standpipe is at the ground line height and then secure to the base flange by tightening the two screws.

4. Stem Rod Adjustments:

Lower the stem rod into the barrel/standpipe, placing the crane coupling over the valve operating nut.

It is necessary that the stem rod engage the operating nut a minimum of 2 inches, but not more than 5 inches.

To check for correct engagement, the end of the stem rod should be from 7 to 10 inches above the top of the standpipe (Fixed Length Units) or the top of the telescoping pipe section.

5. Target (OPEN & SHUT) Adjustments:

Remove the target assembly from inside the top section by rotating the operating nut counterclockwise.

Open Left Valves (shown below)

- Move the OPEN targets to the very top of the target carrier assembly.
- Locate the lower SHUT target according to valve size locating marks on the carrier background.

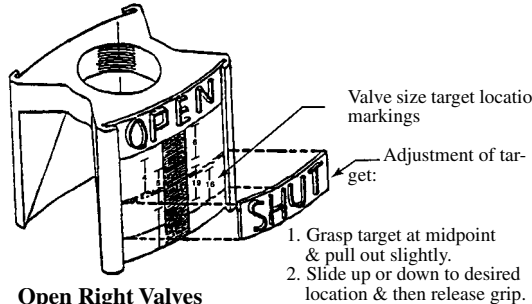

Open Right Valves

- Locate the SHUT targets at the very top.
- Locate the OPEN targets below at the positions indicated by valve size markings.

6. Assembly

Insert the target assembly into the top section by rotating the operating nut clockwise.

Rotate until the OPEN target is centered in the body window, which corresponds with the valve being in the open position.

Lower the top section with target assembly onto the standpipe or barrel, carefully assuring that the stem rod is engaging the operating nut.

Secure the body assembly with the hex bolt and eyebolt.

Close the valve and check the SHUT target position. Readjust if necessary.

Maintenance

1. Lubrication:

Oil upper bearing at least once per year, adding several drops of oil in the hole located on the top of the operating nut.

Access to lubrication hole is gained by raising the locking wrench off of the operating nut.

2. Operation:

The target mechanism will travel off the threads of the operating nut in both directions should the targets or target mechanism be positioned incorrectly. Should this happen, readjust targets. If the target mechanism falls from operating nut, it will be stopped a short distance below the window.

CLOW, KENNEDY & M&H SWING CHECK VALVES

A.W.W.A. C508 was developed in 1976 to set a standard for the manufacture, testing and application of Iron Body Bronze Mounted (IBBM) Check Valves. The valves are designed with an iron body and include either metal-to-metal or rubber-to-metal seating.

Swing Check Valves are designed and manufactured in conformance with A.W.W.A. C508 and are for use on water lines. Under certain circumstances where it is desirable to have more positive control of the closing of the disc, the valves can be supplied with either lever-and-spring or lever-and-weight. For restricted spacing requirements, we manufacture a Wafer Check Valve that also helps to control water hammer.

SWING CHECK VALVE

- Stainless steel hinge pin.
- Working parts are removable through the top of the valve.
- Bosses tapped for drain or bypass available.
- Available with lever-and-spring or lever-and-weight.
- Double bronze side plug construction.
- Bodies are made of high strength cast iron with reinforced flanges - ANSI B 16.1/125 lb.
- May be installed in a vertical line with the flow up.
- Testing 2"-12"
Test Pressure - Seat 150 psi and Shell 400 psi
Working Pressure - non-shock CWP 200 psi

14"-24"

Test Pressure - Seat 150 psi and Shell 300 psi
Working Pressure - non-shock CWP 150 psi

WAFER CHECK VALVE

- Short laying length.
- Spring loaded for more effective control of water hammer.
- Stainless steel spring.
- Resilient seating.
- Easy maintenance with a minimum number of parts.
- Built-in O-Ring flange seals - gaskets not required.
- Mounts between standard ANSI B 16.1/125 lb. flanges. Mounting between 250 lb. flanges requires use of spacers.
- May be installed in a vertical line with flow up or down.
- Testing
Test Pressure - Seat 300 psi and Shell 600 psi
Working Pressure - Non-Shock 300 psi



UL/FM & ULC

**CLOW / KENNEDY / M&H SWING CHECK VALVES
DIMENSIONAL DATA**

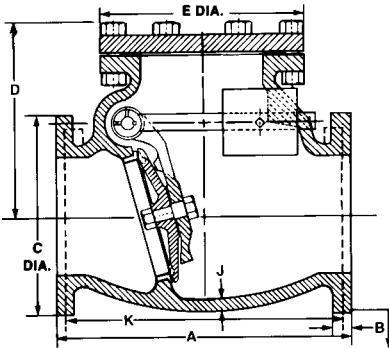

WEIGHT & LEVER SHOWN. SAME DIMENSIONS APPLY TO PLAIN & SPRING & LEVER
DETAIL LW/LS

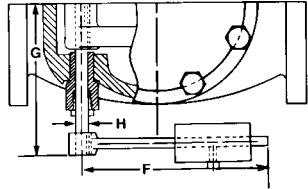

L-BOLT CIRCLE DIA. END FLANGES
M-NO. OF BOLTS PER FLANGE END
N-BOLT HOLE DIA.

SIZE	A	B	C	D	E	F	G	H	J	K**	L	M	N	Q
2"	8.00	.65	6.00	6.00	6.00	5.00	4.72	.50	.34	8.00	4.75	4	.75	4
2-1/2"	8.50	.72	7.00	6.62	7.00	5.25	4.94	.50	.41	8.50	5.50	4	.75	4
3"	9.50	.78	7.50	7.06	7.50	6.00	5.34	.50	.44	9.50	6.00	4	.75	4
4"	11.50	1.00	9.00	8.31	9.00	7.75	8.19	.62	.50	11.50	7.50	8	.75	8
6"	14.00	1.06	11.00	10.06	11.00	9.75	9.00	.75	.62	-	9.50	8	.87	8
8"	19.50	1.25	13.50	12.38	13.50	14.13	10.18	.87	.75	-	11.75	8	.87	8
10"	24.50	1.31	16.00	13.93	16.75	18.00	11.62	1.00	.81	-	14.25	12	1.00	12
12"	27.50	1.37	19.00	16.18	19.00	18.00	13.75	1.00	.87	-	17.00	12	1.00	12

** End to end dimension for threaded end valve.

TECHNICAL/DIMENSIONAL DATA

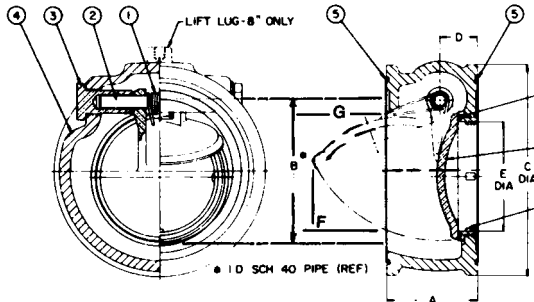
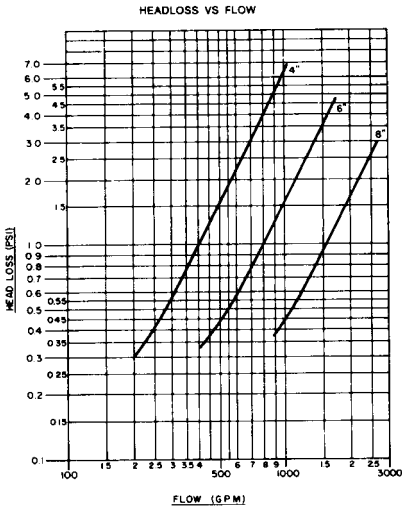

SIZE	A	B	C	D	E
4"	3.75	4.03	6.87	1.34	3.03
6"	3.75	6.06	8.75	1.53	4.56
8"	4.25	7.98	11.00	1.92	6.00

BODY MARKINGS

(ONE SIDE) (OPPOSITE SIDE) (COVER)
SIZE-300 KENNEDY CLOW
706 YEAR M&H

BOSS AND DRAIN TAPPING SCHEDULE

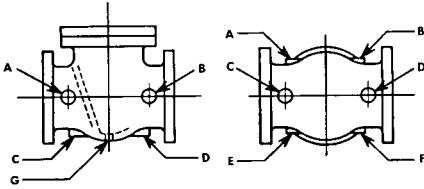

VALVE SIZE (In.)	2-3 1/2	4-5	6	8,10,12
MAX. SIZE PIPE TAP (NPT)	3/4	1	1-1/4	2

When ordering Check Valves tapped for by-pass or drain, specify exact location and size of tap using letters above for boss designation. These locations of drain and by-pass tapplings conform to the Manufacturers Standardization Society Specification SP-45-1953.

**CLOW / KENNEDY / M&H 16"-30" AWWA SWING CHECK VALVE
RUBBER FACED-FLANGED END**

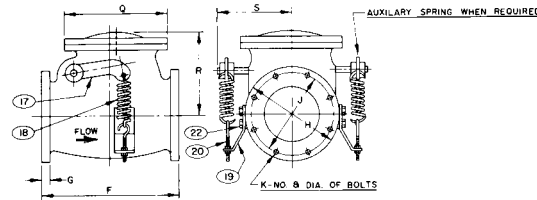

SPRING AND LEVER CHECK VALVE

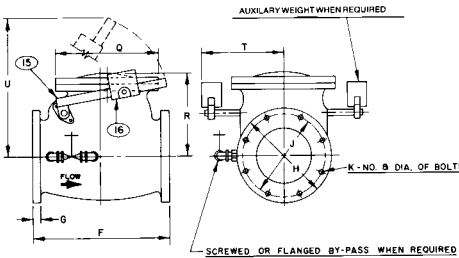

LEVER AND WEIGHT CHECK VALVE

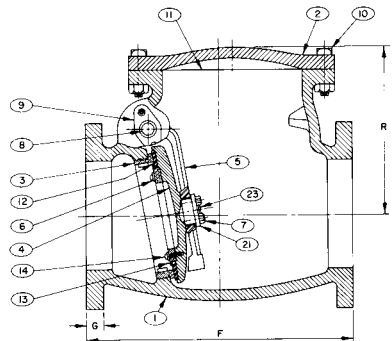

PLAIN CHECK VALVE

DIMENSIONS IN INCHES

VALVE SIZE	14	16	18	20	24	30
E	30	25-3/8	—	—	—	—
F	30	35	36-1/2	37-5/8	44	49-1/2
G	1-3/8	1-7/16	1-9/16	1-11/16	1-7/8	2-1/8
H	18-3/4	23-1/2	25	27-1/2	32	38-3/4
J	12-1	21-1/4	22-3/4	25	29-1/2	36
K	23-1/2	16-1	16-1-1/8	20-1-1/8	20-1-1/4	28-1-1/4
Q	18-3/4	27-1/2	27-1/2	32	38-3/4	43-3/4
R	30	23	25	24-1/2	28	32-7/8
SPRING & LEVER VALVES						
S	15-1/2	17-3/4	18-5/8	20	22-1/2	30-5/8
LEVER & WEIGHT VALVES						
T	17	19-1/2	21	22-3/8	28-1/2	30-5/8
U	32-1/2	34-1/2	40	42	54-1/2	57-1/2

150 LBS – WATER WORKING PRESSURE
300 LBS – HYDROSTATIC TEST PRESSURE

**CLOW / KENNEDY / M&H
INCREASING TYPE CHECK VALVE WITH LEVER & WEIGHT**

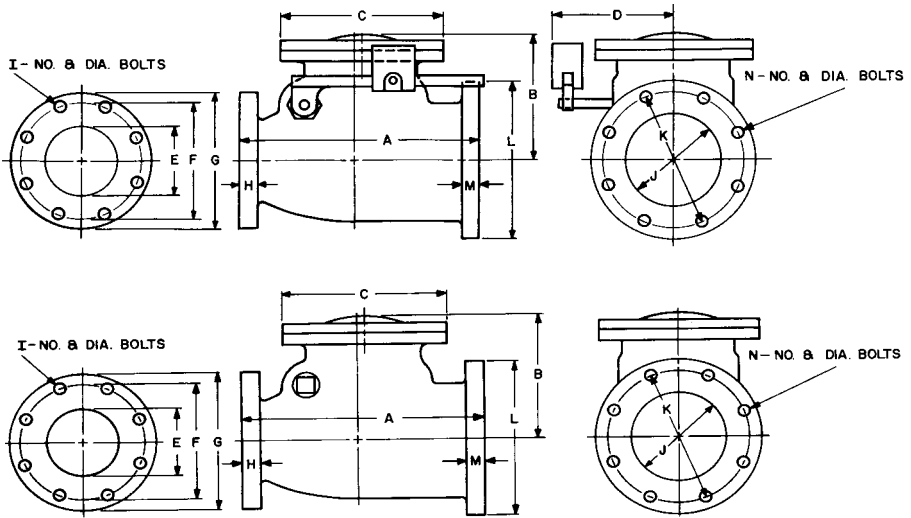

SIZE	A	B	C	D	E	F	G	H	I	J	K	L	M	N
3 X 4	11	6-1/2	7-3/8	5-1/2	3	6	7-1/2	3/4	4-5/8	4	7-1/2	9	15/16	8-5/8
4 X 6	13-1/2	8	9-1/4	7	4	7-1/2	9	15/16	8-5/8	6	9-1/2	11	1	8-3/4
4 X 8	15	8	9-1/4	7	4	7-1/2	9	15/16	8-5/8	8	11-3/4	13-1/2	1-1/8	8-3/4
6 X 8	17	9-3/4	12-1/4	8-9/16	6	9-1/2	11	1	8-3/4	8	11-3/4	13-1/2	1-1/8	8-3/4
6 X 10	17-1/2	9-3/4	12-1/4	8-9/16	6	9-1/2	11	1	8-3/4	10	14-1/4	16	1-3/16	12-7/8
8 X 10	20	12	14-3/4	10-11/16	8	11-3/4	13-1/2	1-1/8	8-3/4	10	14-1/4	16	1-3/16	12-7/8
8 X 12	21	12	14-3/4	10-11/16	8	11-3/4	13-1/2	1-1/8	8-3/4	12	17	19	1-1/4	12-7/8
10 X 12	22-1/2	14-1/4	19	13-1/4	10	14-1/4	16	1-3/16	12-7/8	12	17	19	1-1/4	12-7/8
10 X 16	24-1/4	14-1/4	19	13-1/4	10	14-1/4	16	1-3/16	12-7/8	16	21-1/4	23-1/2	1-7/16	16-1
12 X 16	26-1/2	16-7/16	21	13-7/8	12	17	19	1-1/4	12-7/8	16	21-1/4	23-1/2	1-7/16	16-1
16 X 20	35	21-5/8	27-3/4	17-3/4	16	21-1/4	23-1/2	1-7/16	16-1	20	25	27-1/2	1-11/16	20-1-1/8
20 X 24	38-1/2	24-1/2	32	20	20	25	27-1/2	1-11/16	20-1-1/8	24	29-1/2	32	1-7/8	20-1-1/4

**CLOW / KENNEDY / M&H
INCREASING TYPE CHECK VALVE WITH SPRING & LEVER**

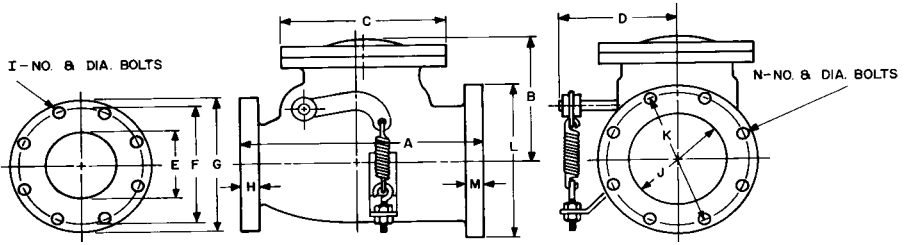

SIZE	A	B	C	D	E	F	G	H	I	J	K	L	M	N
3 X 4	11	6-1/2	7-3/8	6-5/8	3	6	7-1/2	3/4	4-5/8	4	7-1/2	9	15/16	8-5/8
4 X 6	13-1/2	8	9-1/4	7-1/2	4	7-1/2	9	15/16	8-5/8	6	9-1/2	11	1	8-3/4
4 X 8	15	8	9-1/4	7-1/2	4	7-1/2	9	15/16	8-5/8	8	11-3/4	13-1/2	1-1/8	8-3/4
6 X 8	17	9-3/4	12-1/4	9-1/2	6	9-1/2	11	1	8-3/4	8	11-3/4	13-1/2	1-1/8	8-3/4
6 X 10	17-1/2	9-3/4	12-1/4	9-1/2	6	9-1/2	11	1	8-3/4	10	14-1/4	16	1-3/16	12-7/8
8 X 10	20	12	14-3/4	11-1/4	8	11-3/4	13-1/2	1-1/8	8-3/4	10	14-1/4	16	1-3/16	12-7/8
8 X 12	21	12	14-3/4	11-1/4	8	11-3/4	13-1/2	1-1/8	8-3/4	12	17	19	1-1/4	12-7/8
10 X 12	22-1/2	14-1/4	19	14-1/2	10	14-1/4	16	1-3/16	12-7/8	12	17	19	1-1/4	12-7/8
10 X 16	24-1/4	14-1/4	19	14-1/2	10	14-1/4	16	1-3/16	12-7/8	16	21-1/4	23-1/2	1-7/16	16-1
12 X 16	26-1/2	16-3/4	21	15-1/4	12	17	19	1-1/4	12-7/8	16	21-1/4	23-1/2	1-7/16	16-1
16 X 20	35	21-5/8	27-3/4	19-1/8	16	21-1/4	23-1/2	1-7/16	16-1	20	25	27-1/2	1-11/16	20-1-1/8
20 X 24	38-1/2	24-1/2	32	21	20	25	27-1/2	1-11/16	20-1-1/8	24	29-1/2	32	1-7/8	20-1-1/4

**UNDERWRITERS AND FACTORY MUTUAL CHECK VALVES
CLOW / KENNEDY / M&H IRON SWING CHECK VALVES***Underwriters' / Factory Mutual
Underwriters' Canada*

Rubber Disc
Flanged Ends
Size: 2-1/2" Thru 12"



Bronze Disc
Flanged Ends
Size 2-1/2" Thru 12"

Swing Check Valves are for use where backflow is to be prevented. The disc is designed with ample tolerances to compensate for seat ring wear. The spinning action of the disc creates a regrinding effect that cleans the seat ring of foreign particles. The disc is also self-adjusting. All moving parts of these valves are bronze to bronze, minimizing wear and corrosion problems.

These valves are listed by Underwriters' Laboratories and approved by Factory Mutual Fire Research Corp. and have body markings "UL" and "FM" signifying the listing and approval.

Working Pressure:

Cold Water, Non-Shock, 175 Lbs. (2 1/2-12")

Hydrostatic Test Pressure:

Seat and shell, 350 psi. (2 1/2-12")

Construction:

- Bronze Mounted with Bronze Disc or Resilient Disc-2-1/2" & 3"
- Bronze Mounted with Rubber Faced Disc 4"-12"
- Bronze Faced Disc-4"-12"

Approvals:

UL/FM/ULC - 2-1/2-12"

**IRON SWING CHECK VALVES
UNDERWRITERS'/FACTORY MUTUAL/ULC
APPROVED BY N.Y.C. BOARD OF STDS.**

- *Bronze Mounted with Rubber Faced Disc or Bronze Face Disc*
- *2-1/2" thru 12"*

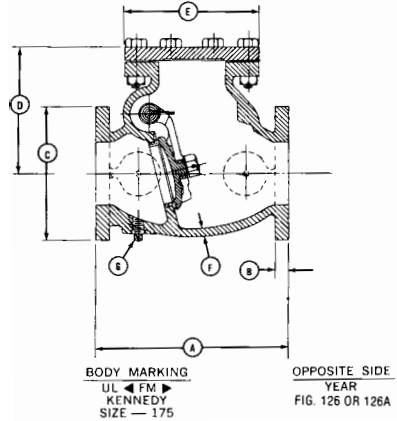
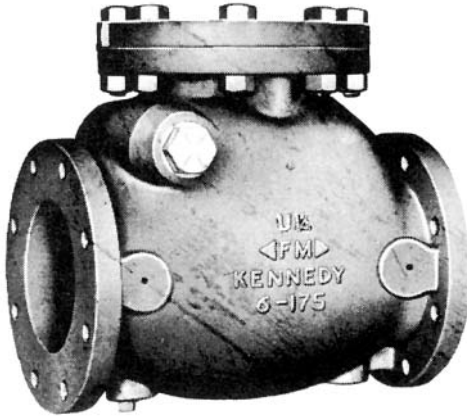

SIZE	A	B	C	D	E	F	G
2-1/2	10	11/16	7	6-7/16	7	13/32	3/4
3	10-1/4	3/4	7-1/2	6-5/8	7-1/2	7/16	3/4
4	13	15/16	9	8-7/16	9	1/2	3/4
5	15	1	10	9-3/16	10	1/2	3/4
6	16	1	11	10-1/8	11	5/8	3/4
8	19	1-1/8	13-1/2	11-7/8	13-1/2	3/4	3/4
10	22	1-3/16	16	13-5/16	16-3/4	13/16	3/4
12	26	1-1/4	19	15-9/16	19	7/8	3/4

SIZE	WEIGHT – POUNDS							
	2-1/2"	3"	4"	5"	6"	8"	10"	12"
Fig. 126	52	62	114	145	193	319	475	680
Fig. 126-A	53	62	117	145	196	322	480	685

Working Pressures:

2-1/2" – 12" Cold Water, Non-Shock, 175 lbs.

Approvals:

UL/FM/ULC – 2-1/2" – 12" Fig. 126 and 126A

Hydrostatic Test Pressure:

2-1/2" – 12" Seat 175 psi and Shell – 350 psi.

KENNEDY GROOVED CHECK VALVES
FIGURE 426 UL LISTED / FM APPROVED
SIZES 2 1/2", 3", 4", 6", 8"
Working Pressure: 250 PSI

The Kennedy Figure 426 Grooved End Swing Check Valve is a lightweight unit that features a top access cover for field maintenance. The valves are intended to be easily installed with approved grooved coverings. They may be installed either with the flow in a vertical position or horizontally. All valves have a 1/2" NPT connection on the inlet side for installation of a 1/2" Ball drip.

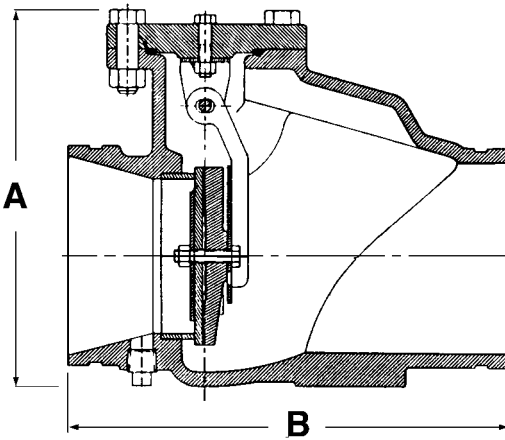

DIMENSIONAL DATA

	HEIGHT	WIDTH
	A	B
2.5" =	7.22	8.625
3" =	7.68	9.120
4" =	8.54	9.990
6" =	11.34	13.280
8" =	12.86	14.500

WEIGHT/POUNDS

2.5" =	19 LB.
3" =	21 LB.
4" =	29 LB.
6" =	61 LB.
8" =	81 LB.

FRICTION LOSS

2-1/2"	1.3 PSI @250 GPM
3"	1.0 PSI @ 250 GPM
4"	1.2 PSI @ 600 GPM
6"	.91 PSI @ 1350 GPM
8"	.70 PSI @ 2300 GPM

GROOVED CHECK VALVES

*UL Listed / FM approved
 Sizes 2 1/2", 3", 4", 6", 8"
 Working Pressure: 250 PSI*



Grooved Check Valve may also be used as a Riser Check Valve. This valve would be a lightweight substitute for an "Alarm Valve Assembly". The valve is intended to be installed vertically in a sprinkler riser, with appropriate trim (optional purchase). Each valve is tapped 1/4" NST both above and below the clapper for pressure gauges, and 1 1/4" or 1 1/2" NSP (depending on valve size) for the drain outlet.

Features:

Complete Size Range 2 1/2" - 8"
 250 Psi Rating

EPDM Disc, Ductile Iron Body & Clapper
 304 S.S. Clapper Assembly
 Top Entry Design

FRICTION LOSS

2 - 1/2"	1.3 PSI @ 250 GPM
3"	1.0 PSI @ 250 GPM
4"	1.2 PSI @ 600 GPM
6"	.91 PSI @ 1350 GPM
8"	.70 PSI @ 2300 GPM



CLOW / KENNEDY / M&H CUSHION CHECK VALVES

Kennedy Valve, Clow & M&H produce check valves to meet the needs of pump stations, distribution, and treatment systems.

For elimination of water hammer in these applications, piping system design is the prime consideration. Swing check valves with lever & spring or lever & weight are designed to provide quick closure in advance of the potential of reversal of water flow direction.

For applications where the customer requires an arrangement that retards the closure of the check valve, the cushion check valve is also available. This is a modified AWWA valve with the addition of a pneumatic cylinder arrangement. The pneumatic cylinder has a needle valve that allows the customer to adjust the time required for the valve to close.

The cushion check meets or exceeds the performance requirements of AWWA C508, latest revision. Pressure ratings for 2.5" thru 12" valves are 200 PSI.

Lay lengths for flanged end valve meet the revised AWWA standards as follows;

SIZE	LAY LENGTH
3	9.5
4	11.5
6	14
8	19.5
10	24.5
12	27.5

The cushion check valve may be ordered from the factory either as flow horizontal or upward flow in vertical pipelines. The cylinder arrangement is available mounted on either side. Unless specified the valve will be supplied with the cylinder on the right side when facing the inlet for horizontal flow.

The cushion check valve has internal components identical to our standard check valves, except that the hinge pin is made of heat treated type 431 stainless steel.



GROOVED END BUTTERFLY VALVES
2-1/2" TO 8"
WITH SUPERVISORY TAMPER SWITCH
FIGURE 93G1 - 175 PSI
UL Listed /FM Approved

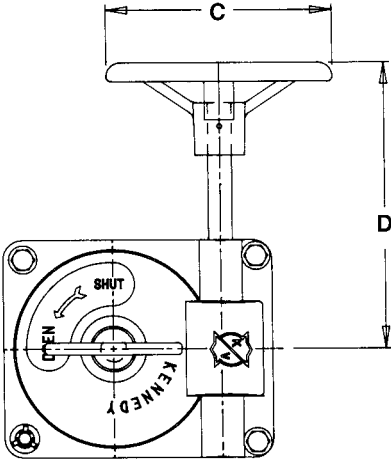

1. **Upper & Lower Shafts:** 416 Stainless Steel
2. **Body Coating:** Fusion Bonded Nylon 11
3. **Disc Encapsulation Material:** SBR

SIZE	A	B	C	D	E	F	Wt#
2.5"	2.85	3.81	6.0	7.6	10.30	5.35	16
3"	3.47	3.82	6.0	7.6	10.77	5.58	20
4"	4.47	4.57	6.0	7.6	12.86	6.68	24
6"	6.61	5.83	6.0	7.6	15.73	8.36	37
8"	8.61	5.27	6.0	7.6	17.56	9.28	43

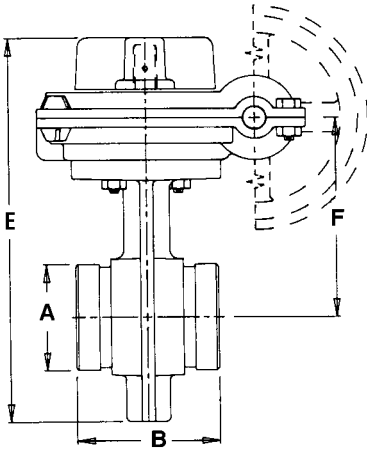

SUPERVISORY TAMPER SWITCH & AUXILIARY SWITCH
ELECTRICAL SPECS, MAX: 28 VDC, 120 VAC, 0.25 AMP

TAMPER SWITCH

AUXILIARY SWITCH

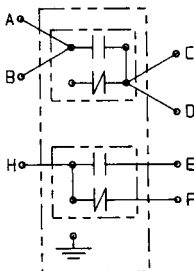

WIRE	COLOR	MODE
A	BLACK	N/O
B	BLACK	N/O
C	BLUE	COMMON
D	BLUE	COMMON
E	BLACK/WHITE	N/O
F	RED	N/C
H	BLUE/WHITE	COMMON

WAFER BUTTERFLY VALVES
2-1/2" TO 8"
WITH SUPERVISORY TAMPER SWITCH
FIGURE 93W1 - 175 PSI
UL Listed /FM Approved

1. **Upper & Lower Shafts:** 416 Stainless Steel
2. **Body Coating:** Fusion Bonded Nylon 11
3. **Disc Encapsulation Material:** SBR

SIZE	A	D	E	F	G	H	WT#
2.5"	1.81	7.6	10.30	5.35	1.81	1.72	20
3"	1.81	7.6	10.77	5.58	1.81	2.39	20
4"	2.05	7.6	12.86	6.68	2.05	3.31	25
6"	2.21	7.6	15.73	8.36	2.21	5.60	34
8"	2.36	7.6	17.56	9.28	2.36	7.49	44

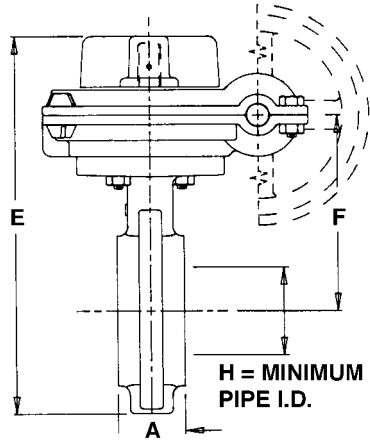
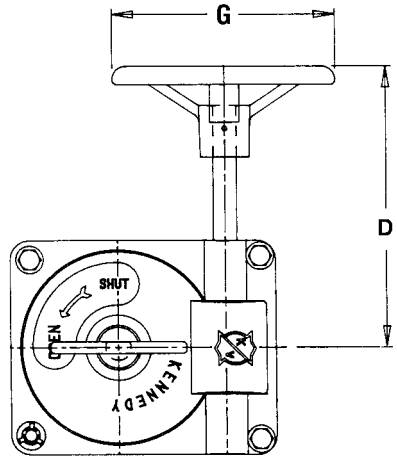

SUPERVISORY TAMPER SWITCH & AUXILIARY SWITCH
ELECTRICAL SPECS, MAX: 28 VDC, 120 VAC, 0.25 AMP

WIRE	COLOR	MODE
A	BLACK	N/O
B	BLACK	N/O
C	BLUE	COMMON
D	BLUE	COMMON
E	BLACK/WHITE	N/O
F	RED	N/C
H	BLUE/WHITE	COMMON

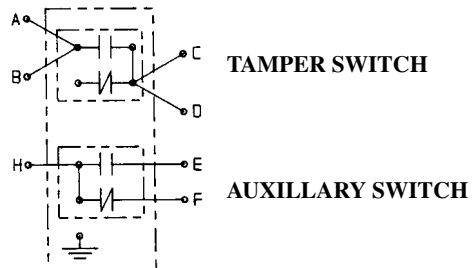

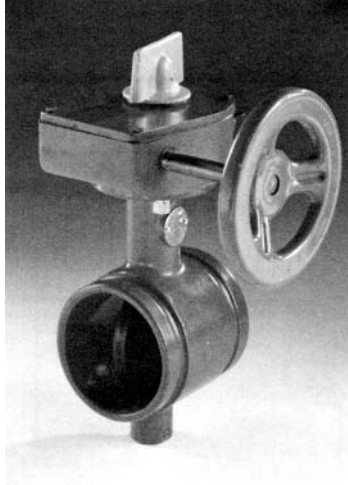
GROOVED END BUTTERFLY VALVES
*New, Improved Design***4-8" Sizes UL Listed****3-8" Sizes FM Approved****Figure 83M 300 PSI**

KENNEDY VALVE introduced the FIRST UL Listed Grooved End Butterfly Valve in 1982.

Specifically designed for the Fire Protection Industry with the following features:

- Available in sizes: 3", 4", 5", 6", and 8
- UL Listed FM Approved.
- Single pole/single throw monitor switch standard on all valves.
- Double seal design for bubble-tight shutoff at 300 PSI.
- Corrosion resistant fusion bonded Nylon II body coating.
- Easy to read, Flag type position indicator.
- Low torque operation, high cycle life.
- Light weight.
- Approved by N.Y.C. Material and Equipment Acceptance.

**UNDERWRITERS AND FACTORY MUTUAL
GROOVED END BUTTERFLY VALVES**
4-8" Sizes UL Listed
3-8" Sizes FM Approved
With Single Pole/Single Throw Monitor Switch
Figure 83M-300psi

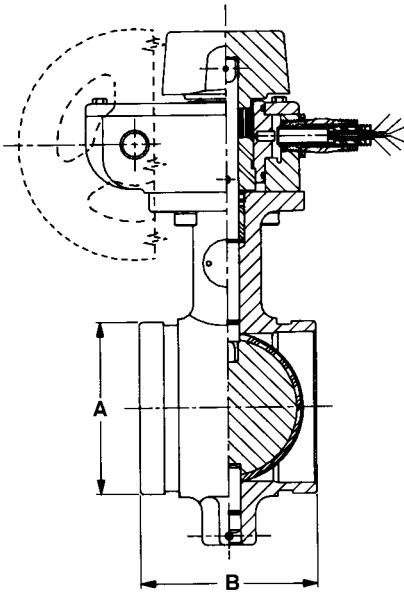

1. **Upper & Lower Shafts:** 416 Stainless Steel
2. **Body Coating:** Fusion Bonded Nylon 11
3. **Disc Encapsulation Material:**
EPDM: Standard
Buna-N: Optional

SIZE	A	B	C	D	E	F	WT#
3"	3.48	3.82	6.00	6.62	11.18	5.47	20
4"	4.47	4.56	6.00	6.62	13.41	6.85	24
5"	5.54	5.81	6.00	6.62	14.59	7.81	33
6"	6.61	5.81	6.00	6.62	16.27	8.43	39
8"	8.61	5.25	6.00	6.62	19.50	10.25	47

With Single Pole/Single Throw Monitor Switch
Figure 83M - 300 PSI

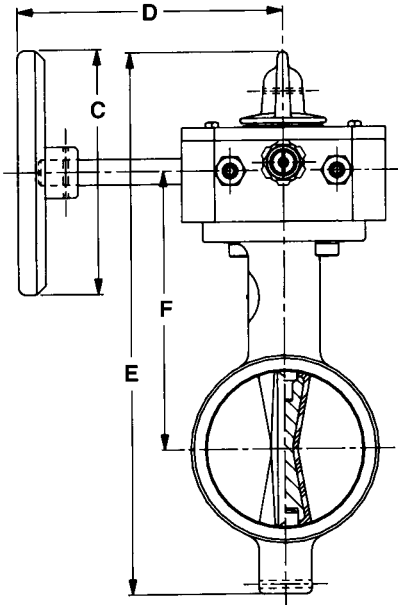

ELECTRICAL SPECS, MAX: 28VDC .25A

TYPES: 4, 4X, 6, 6P

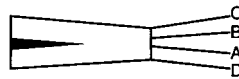

WIRE	COLOR	MODE
A	BLUE	COMMON
B	BLUE	COMMON
C	BLK	N/O
D	BLK	N/O

CLOW / KENNEDY / M&H MUD VALVES

Iron Body Bronze Mounted 4" thru 24"



Flanged Ends
Non-Rising Stem



Flanged Ends
Rising Stem



Spigot Ends
Rising Stem

SPIGOT ENDS, NON-RISING STEM ALSO AVAILABLE (NOT ILLUSTRATED)
CAN ALSO BE FURNISHED WITH SLIDING STEM (NOT ILLUSTRATED)

Mud Valves are designed for settling basin drain lines, sump blow-offs, swimming pool drains, waterworks, sewage and filtration plants, irrigation systems, and industrial installations. They are recommended for use in lines of low seating or unseating pressures only.

Mud Valves are either rising stem, non-rising stem or sliding stem type. Bodies are cast iron. The stem, stem nut, disc ring, and seat ring are bronze. Bolts and nuts are rust-proofed steel.

Mud Valves can be furnished with hand-wheel or operating nut as required. They can also be furnished with extension stem, with plain or indicating floor stand, and can be furnished for cylinder operation if required.

When ordering extension stem, state length, and give distance from bottom face of flange to top of handwheel or nut, or to base of floorstand. Spigot end valves are available in any desired length up through 12 inches.

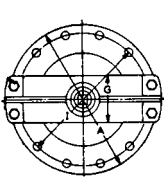

Non-rising Stem

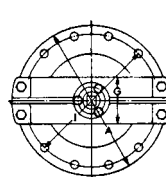
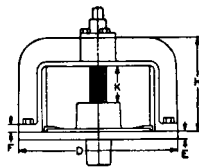

Rising stem

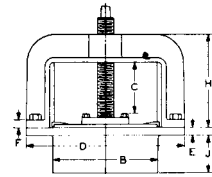

DIMENSIONS - INCHES

VALVE SIZE INCHES	4	6	8	10	12	14	16	18	20	24
A DIAMETER OF BODY FLANGE	9	11	13-1/2	16	19	21	23-1/2	25	27-1/2	32
B OUTSIDE DIAMETER OF SPIGOT	4-7/8	7	9	11-1/4	13-3/8	15-1/4	17-5/8	19-3/4	21-3/4	25-3/4
C TRAVEL OF GATE (RISING STEM)	1-7/8	2-1/2	4-1/2	4-1/4	4-3/4	6-5/8	7	8-11/16	8-5/8	10-5/8
D OVERALL WIDTH AT YOKE	10	12-1/4	14-1/2	17	19-3/4	23	25-3/4	29	29-1/2	37
E THICKNESS OF BODY FLANGE	7/8	7/8	7/8	7/8	1	1-1/4	1-1/4	1-1/4	1-1/2	1-7/8
F THICKNESS OF YOKE FLANGE	5/8	3/4	7/8	7/8	1	1-1/4	1-3/8	1-1/2	1-3/8	1-5/8
G WIDTH OF YOKE	2-1/4	2-1/2	3	3-1/2	4	6	6	6-1/2	7	7
H HEIGHT OF YOKE	5-5/8	6	8	8	9	11-1/8	14	15-1/2	16-7/8	20
I DIAMETER OF BOLT CIRCLE	7-1/2	9-1/2	11-3/4	14-1/4	17	18-3/4	21-1/4	22-3/4	25	29-1/2
J LENGTH OF SPIGOT	12	12	12	12	12	12	12	12	12	12
K TRAVEL OF GATE (NON-RISING STEM)	1-7/8	2-1/2	4-1/2	4-1/4	4-3/4	5-1/8	5	5-1/4	6-1/2	10

**CLOW / KENNEDY / M&H FLAP VALVES
IRON BODY, BRONZE MOUNTED
4" THRU 30"**



Flanged End



Spigot End



Hub End

Flap Valves are used for end closure of outfall lines, or in manholes, to prevent entrance of backwater. They swing open under direct pressure to release the outfall fluid and close when the direct pressure is relieved. Back pressure serves to hold the gate against its seat.

Flap Valves are used in filtration and sewage disposal plants and in various industrial installations, and are regularly furnished fully bronze mounted, with bronze hinge pin, flap ring, and seat ring. Flap valves are available in sizes 4 thru 30 inches.

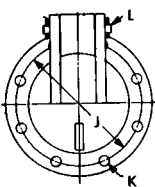

End View

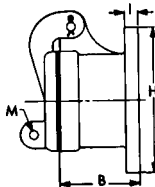

Flanged End

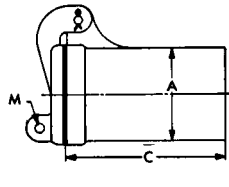

Spigot End

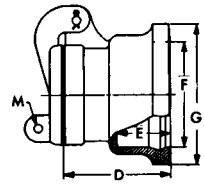

Hub End

DIMENSIONS - INCHES

VALVE SIZE INCHES	4	6	8	10	12	14	16	18	20	24	30	
A	OUTSIDE DIAMETER OF SPIGOT	4-7/8	7	9	11-1/4	13-3/8	15-3/8	17-1/2	19-1/2	21-1/2	25-3/4	31-3/4
B	FACE OF SEAT TO FACE OF FLANGE	4	6	8	8	8	10	10	10	10	10	10
C	FACE OF SEAT TO END OF SPIGOT	12	12	12	12	12	12	12	12	12	12	10-1/4
D	FACE OF SEAT TO END OF HUB	8	8	8	8	8	10	12	12	12	13-1/2	-
E	DEPTH OF HUB	4	4	4	4	4	4	4	4	4	4	-
F	INSIDE DIAMETER OF HUB	5-3/4	7-7/8	10	12-1/8	14-1/4	16-3/8	18-1/2	20-1/2	23	27-1/4	-
G	OUTSIDE DIAMETER OF HUB	8	10-3/4	12-7/8	15	17-1/2	19-1/2	21-3/4	23-3/4	27-1/4	31-1/8	-
H	DIAMETER OF END FLANGE	9	11	13-1/2	16	19	21	23-1/2	25	27-1/2	32	38-3/4
I	THICKNESS OF END FLANGE	3/4	7/8	1	1	1-1/8	1-1/4	1-1/4	1-1/4	1-3/8	1-1/2	1-1/2
J	DIAMETER OF BOLT CIRCLE	7-1/2	9-1/2	11-3/4	14-1/4	17	18-3/4	21-1/4	22-3/4	25	29-1/2	36
K	NUMBER AND SIZE OF BOLTS	8-5/8	8-3/4	8-3/4	12-7/8	12-7/8	12-1	16-1	16-1-1/8	20-1-1/8	20-1-1/4	28-1-1/4
L	DIAMETER OF FLAP PIN (BRONZE)	5/8	5/8	5/8	3/4	3/4	7/8	7/8	7/8	1	1	1-1/4
M	DIAMETER OF FLAP LUG HOLE	5/8	5/8	5/8	3/4	3/4	7/8	7/8	7/8	1	1	1

Flanges are faced and drilled to ANSI 125 pound template, unless otherwise instructed.

M&H / CLOW SHEAR GATES
Iron Body, Bronze Mounted
4" Thru 30"

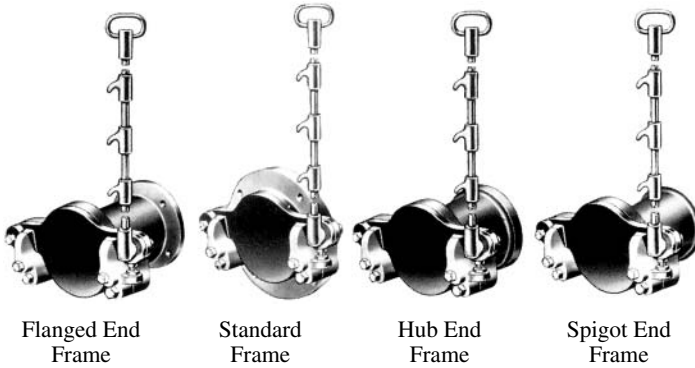

Shear Gates are designed for use in both water and sewage plants for filling or emptying tanks, for low pressure sludge discharge lines, and similar applications. They are recommended for use in lines of low seating pressure only, and can be furnished in any of the frame types shown above. The wedges that seat the gate are bolted on to permit replacement without the expense of a new frame if the wedges should become worn. Standard length of lifting handles is 2 feet for all size gates. Extended handles can be furnished. State length required when ordering.

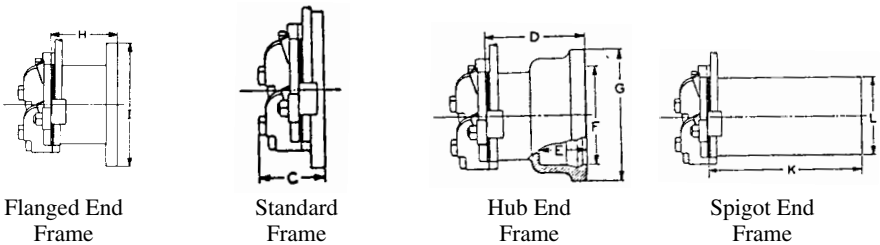

DIMENSIONS - INCHES

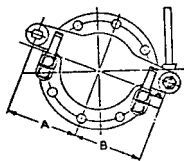

End View of Shear Gates

VALVE SIZE INCHES	4	6	8	10	12	14	16	18	20	24	30
A	5	6-1/4	7-5/8	9	10-1/4	11-3/8	14	14-5/8	16	18	22
B	5	6-1/4	7-5/8	9	10-1/4	11-1/2	14	15	16-1/2	18-1/2	22
C	4-1/2	4-3/4	4-3/4	4-7/8	5	5-7/8	5-1/2	5-3/4	6-1/4	7-5/8	9-1/2
D	8	8	8	8	8	8-1/2	8-1/4	8-1/4	12-5/8	12-5/8	
E	4	4	4	4	4	4	4	4	4	4	-
F	5-3/4	7-7/8	10	12-1/8	14-1/4	16-3/8	18-1/2	20-1/2	23	27-1/4	-
G	8	10-3/4	12-7/8	15	17-1/2	19-1/2	21-3/4	23-3/4	27-1/4	31-1/8	-
H	4	6	8	8	8	8-1/4	8-1/4	8-1/4	9-7/8	10-5/8	13-1/4
I	9	11	13-1/2	16	19	21	23-1/2	25	27-1/2	32	38-3/4
K	12	12	12	12	12	14-1/2	14-1/4	14-1/4	14-7/8	15-1/8	13-1/4
L	4-7/8	7	9	11-1/4	13-3/8	15-3/8	17-3/8	19-1/2	21-1/2	26	31-1/2

Flanges are faced and drilled to ANSI 125 pound template, unless otherwise instructed.

CLOW / KENNEDY / M&H FLOOR AND BENCH STANDS



Standard Pattern
Non-rising Stem,
Indicating
Rising Stem



Rising Stem
Heavy Pattern
Non-rising Stem
NRS-Indicating

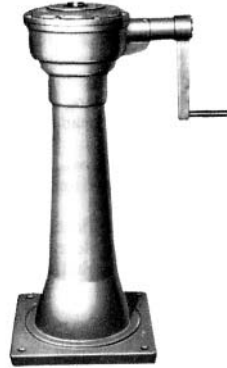

Extra Heavy Geared
Pattern
Non-rising Stem
NRS-Indicating

Floor Stands are available in Standard, Heavy, and Extra Heavy Geared Patterns with either rising or non-rising stems. Non-rising stem floor stands can be equipped with indicators to show valve position.

Floor Stands are of high strength cast iron, and may be provided with extension stems of steel, stainless steel, or bronze as specified.

Gearing and enclosed gear cases can be furnished for floor stand operation of large valves. For non-rising stem valves, we recommend that the gearing be installed on the valve rather than on the stand.

Cranks are furnished on geared floor stands when specified. The use of cranks rather than handwheels is recommended on all Extra Heavy Pattern Floor Stands. Handwheels can be furnished if specified.

Ball thrust bearings and motor operated floor stands can be furnished when specified.

Stem covers are furnished, when specified, for rising stem floor stands. Brass name plates can be furnished for floor stands as specified.

DIMENSIONS - INCHES

DIMENSIONS	STANDARD PATTERN	HEAVY PATTERN	EX. HEAVY GEARED PATTERN
A	13-1/4	14	16 SQ.
B	11-1/2	12	13-1/2
C	4-1/2	4-5/8	4-7/8
D	6	7	11
E	3	5	6
F	38	38	-
G	36	36	-
H	-	-	38-3/4
I	-	-	36
J	-	-	12
K	-	-	21

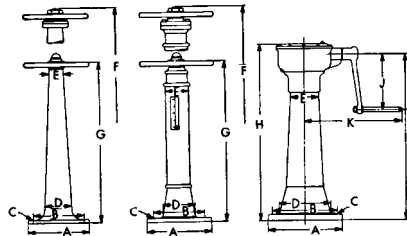

Standard Pattern

Heavy Pattern

Extra-Heavy Pattern

B=Diameter of bolt circle.

C=Number and size of bolts.

Rising Stem Bench Stands

Bench Stands are similar in operation to the floor stands described above. They can be mounted on any upright surface such as tank walls and in most uses eliminate the need of stem guides or special brackets, depending upon length of stem. Bench Stands are furnished for sliding stem valves only. We regularly furnish the Stem Guide for NRS valves.



Bench Stand Rising Stem

CLOW / KENNEDY / M&H FLOOR STAND ARRANGEMENTS



NRS Floor Stand with NRS Gate Valve



Rising Stem Floor Stand with Sliding Gate Valve

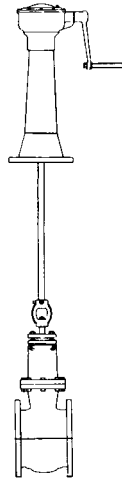

NRS Geared Floor Stand with NRS Valve

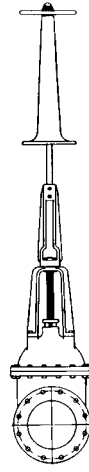

NRS Floor Stand with OS&Y Valve

Note: Rising Stem Floorstands cannot be used with OS&Y valves. When position of OS&Y valve must be known, use the NRS indicating Floorstand with special yoke attachment.

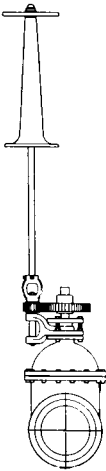

NRS Floor Stand with NRS Spur Geared Valve

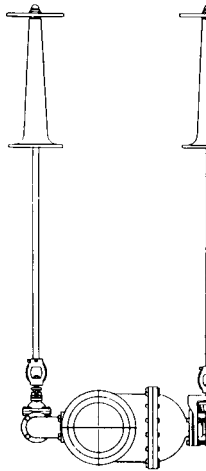

NRS Floor Stand with Bevel Geared Valve, and NRS Floor Stand for BY-pass Valve



NRS Indicating Floor Stand with NRS Bevel Geared Valve



NRS Floor Stand with OS&Y, Spur Geared Valve

CLOW / KENNEDY / M&H STEM GUIDES, CHAIN WHEELS AND FLOOR BOXES



Stem Guide

STEM GUIDES

Stem Guides are installed as wall brackets to support extension stems. They are fully adjustable and are made of high strength cast iron. The guide is bronze brushed where the extension stem passes through. They should be installed at a height which does not permit the stem to be unsupported through a length of more than 10 feet.

Stem Guides are available in five sizes. When ordering state distance from center line of operating stem to face of wall, or give the size number as shown in table.

ADJUSTMENT FROM WALL - INCHES

SIZE NUMBER	1	2	3	5	6
MINIMUM INCHES	1-7/8	2-1/4	6-1/2	15	15
MAXIMUM INCHES	5	12-1/2	16-3/4	25	35



Chain Wheel on NRS Valve

CHAIN WHEELS

Chain Wheels are normally used for operation of valves located overhead. They are provided with chain guides to prevent the chain from slipping off the wheel. Chains can be furnished rust proofed if specified. Chain Wheels are mounted directly on the handwheel, and are of approximately the same diameter.

In ordering please state distance from floor to center line of wheel, or give the exact number of feet of chain required.

FLOOR BOXES

Floor Boxes are designed for installation in concrete floors or slabs to provide support for extension stems of the non-rising type, and to provide a cover for the operating nut on the extension stem. The plain type is available in any length up to 12". The Bushing Type can be furnished a minimum of 7" thru 12" maximum length.

The bushing type floor boxes are similar in design and construction with the Plain Type Floor Boxes, but are fitted with bronze bushings to preserve stem alignment.

In ordering, state size of extension stem, length required or thickness of floor.

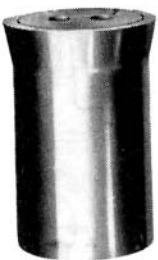

Floor Box
Plain Type



Floor Box
Bushing Type

**CLOW / KENNEDY / M&H CAST IRON PRESSURE RELIEF VALVES
FLOOR TYPE**



Floor Type Pressure Relief Valve

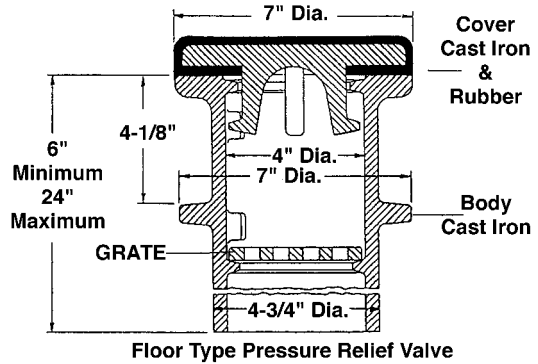

Sectional View

4" Diameter only. Must be installed in Vertical Position. Body Lengths: Minimum is 6 inches, maximum is 24 inches, specify length when ordering. Dimensions shown on line illustration are "fixed" dimensions.

STANDARD BODY LENGTH INCHES	6	8	10	12	14	16	18	20	22	24
WEIGHT, COMPLETE POUNDS	25	27	29	32	35	38	41	44	47	50

Pressure relief valves are for placing in the bottom of concrete tanks to keep empty tanks from floating when there is an excess of ground-water underneath and around them. When this condition exists, the outside water pressure will raise the cover of the valve and allow the water to enter the tank and equalize pressures inside and outside of tank and, thus, prevent the tank from floating.

The valves can be furnished in any body length from 6 inches thru 24 inches in increments of one inch. Standard body lengths are listed above.

Pressure Relief Valves are so constructed that neither the cover or strainer can become separated from the body of the valve, due to ground-water pressure around the tank. However, when necessary, both may be easily removed by turning them to the right or left to free them from the locking lugs cast on inside of body. The cover weighs approximately 6 pounds and starts to open at a head of approximately 9" of water.

TYPICAL INSTALLATION

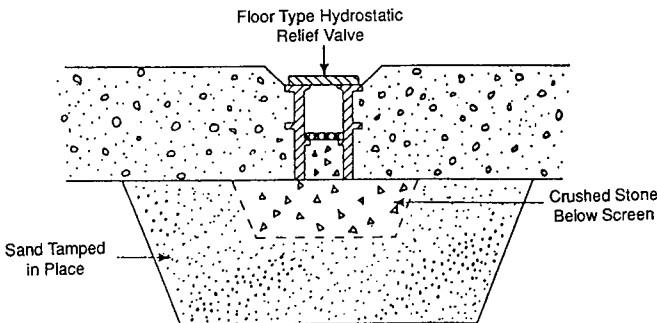

Important Note:

In order for the floor type valve to operate correctly, it must be installed in a vertical position.

**CLOW / KENNEDY / M&H CAST IRON
PRESSURE RELIEF VALVES
WALL TYPE PRESSURE RELIEF VALVE**

**WALL TYPE PRESSURE RELIEF VALVE
4" DIAMETER ONLY**

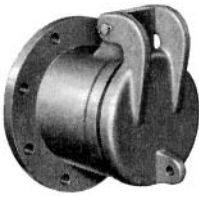

The Wall Type Pressure Relief Valve is for side wall installation in tanks and digesters. The valve has a 4" flanged end for connection to a 4" flanged wall pipe. Iron body, bronze mounted, it is equipped with a soft, composition rubber seat, so that if particles of grit lodge on it, the head of liquid in the tank will still force the flap closed tightly, and prevent seepage of liquid out into the ground. The seating material has been chosen for its resistance to deteriorating effect of the sewage.

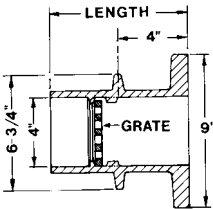

WALL PIPE

A special 4 inch wall pipe for use with wall-type pressure relief valves. It is a gray iron flange and plain end wall pipe with an internal grate. The flange is faced and tapped for studs to 125 pound template. The Wall Pipe is available in lengths from 8 inches thru 22 inches in increments of 2 inches. The plain end can be cut off to obtain shorter lengths. No flange accessories will be furnished unless ordered separately.

LENGTH IN.	8	10	12	14	16	18	20	22
APPROXIMATE WT. LBS.	25	28	31	33	36	39	41	43

TYPICAL INSTALLATION

Important Note:
In Order for the wall-type valve to operate correctly, the wall pipe and valve must be installed so that the bolt holes in the flange straddle the vertical centerline.

The wall pipe must be ordered separately.

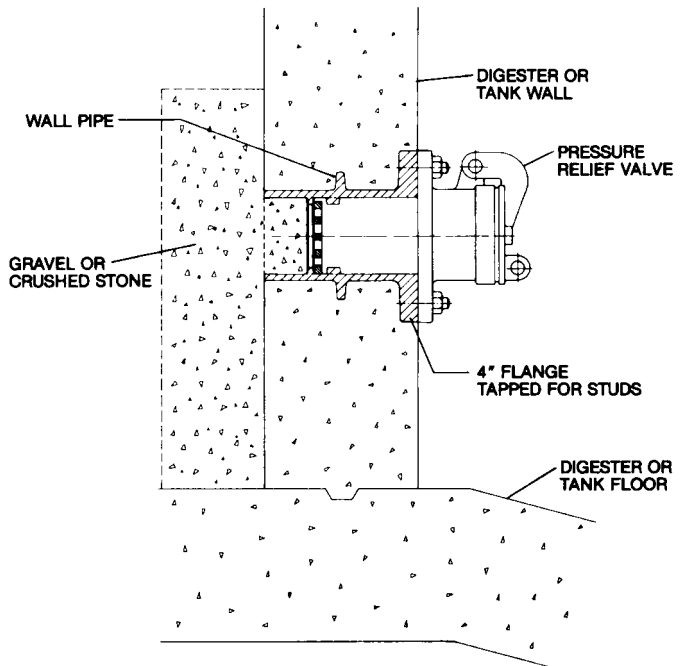

M&H / CLOW 4500 AWWA C504 BUTTERFLY VALVES

• For Underground Applications

• Now, with M&H Butterfly Valves you gain new valve reliability

• 4500 - 4"-24"

• NSF Approved

The M&H / CLOW Butterfly valve is rugged and dependable; it will work easily any time you need it. Because of this ruggedness and reliability - plus positive, 100% shut-off - you achieve a more efficient, trouble-free distribution system.

No More Damaged Stems. Since the M&H / CLOW Butterfly Valve does not "freeze" shut or stick, it is always readily operable. Should inexperienced workmen attempt to overtighten it, the tough 450 pounds input torque rating of the operator at ends of travel protects stem and operating parts against damage. This input torque rating is unparalleled in standard valves for this application. When it is considered that conventional watermain valves have torque input limitations as low as 150 foot pounds, the margin of safety provided by this M&H / CLOW design is an important factor in long, trouble-free valve life.

Bottle-Tight Seal. With the M&H / CLOW Butterfly Valve, you get positive 100% shutoff. Rubber vane-seat and stainless steel valve-seat construction provides a permanent uninterrupted 360-degree bottle-tight closure.

Water Sealed Out. Underground operator and end cover are permanently sealed against ground-water infiltration.

Working Parts Corrosion-Free. All critical bearing and sealing surfaces are stainless steel, Teflon®* or rubber - assures easy and efficient valve operation, permanently.

Low Initial Cost. The M&H / CLOW Butterfly Valve has standardized components which offer you lowest initial cost and off-the-shelf availability. Expensive accessories are not required. No by-passes, special gearing, etc.

Easy Installation. The M&H / CLOW Butterfly Valves are compact, light-weight, easy to install. Installation costs are kept to a minimum.

Maintenance-Free. Permanently lubricated - no packing adjustment, no periodic exercising, no stem replacement of the M&H Valve is required. The closing action of the vane is self-cleaning and there are no pockets in which sediment or sludge formations can deposit, resulting in longer lifetime service.

*DuPont registered trade name.

AVAILABLE IN CLASS 250

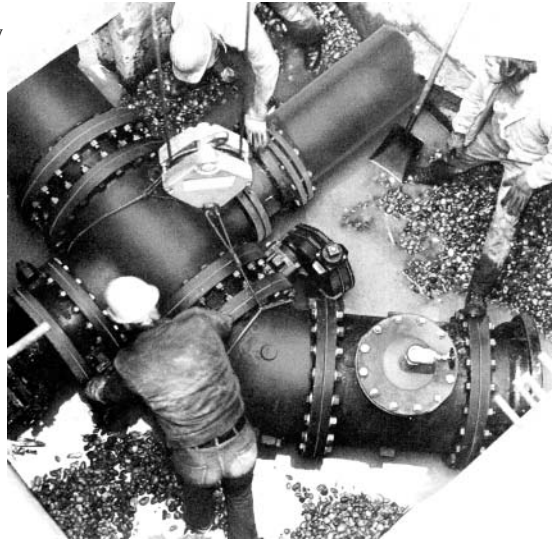

M&H / CLOW 4500
• AWWA C504 Butterfly Valves
• 4500 - 4"-24"
For Underground Application

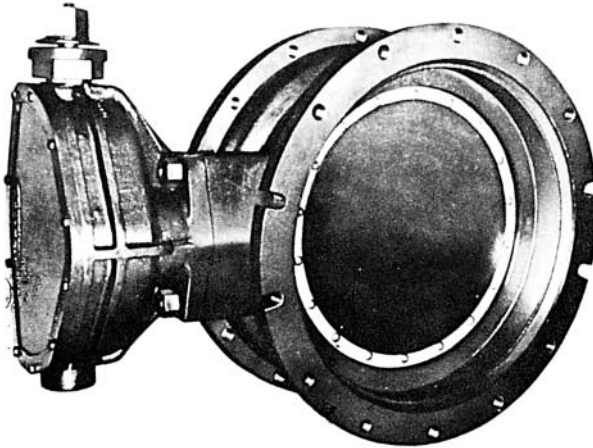

Working Pressure:

- 4" through 12" sizes - 200 psi
- 14" through 24" sizes - 150 psi

Hydrostatic Test Pressure:

- 4" through 12" sizes - 400 psi
- 14" through 24" sizes - 300 psi

250 PSI WWP available

250 Flange available

ENDS AVAILABLE	4"-12"	14"-20"	24"
MECHANICAL JOINT	*	*	*
WAFER	*	*	
FLANGED	*	*	*
FLANGED X M/J	6",8",12"	16"	

NOTE: *Indicates availability

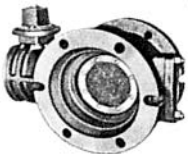

Mechanical Joint End

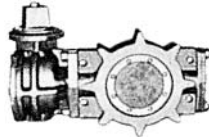

Wafer End

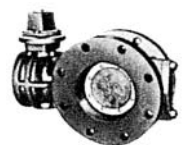

Flanged End

M&H / CLOW 4500 AWWA BUTTERFLY VALVES C504

- *For In-Plant Applications*
- *Engineered for long & trouble-free operation*
- *Eliminates expensive and time-consuming shutdowns*



Name your criteria for in-plant valve evaluation... performance, economy, maintenance, reliability, versatility. The M&H / CLOW 4500 Butterfly Valve is Number One in every category.

This is a rugged valve, able to handle severe operating conditions and assure bottle-tight shut-off. It eliminates many nagging, frustrating problems of other valves.

For in-plant applications, the M&H / CLOW valve offers the many advantages of the underground model -- ruggedness, shaft strength, bottle-tight seal, corrosion-free critical parts, freedom from excessive maintenance. In addition, you obtain...

Low Cost Installation. M&H / CLOW Butterfly Valves are compact, lightweight, easy to install. Installation costs are kept to a minimum.

Efficient Throttling. M&H / CLOW Butterfly Valves provide a highly effective method of throttling and control. The vane is held solidly, without chatter, in any desired control position.

Wide Selection of Operators and Pipe Connections. The cylinder, crank, handwheel, square nut, electric motor and hand-lever operators are available on all pipe-end connections, in sizes four inches and larger. The hand-lever model has several latched vane positions from full-open to full-closed.

Interchangeable Parts and Operators. For Style 4500 Butterfly Valve, all component parts are 100% interchangeable between valves of the same size. If necessary operators can be interchanged in the plant, shop or warehouse. For example, if you should wish to change from a crank operator to a cylinder operator, you loosen two bolts, slide the crank operator from the drive shaft, replace with the cylinder operator -- tighten bolts in accordance with factory instruction sheet. This exclusive interchangeability substantially reduces inventories and related costs.

Choice of Valve Types. Wafer and Flanged-end butterfly valves are ideal for in-plant applications.

Accessories. Floor stands, extension stems, chain wheels, solenoid valves, speed control valves, valve positioners, limit switches, etc., electric motor operators are available.

M&H / CLOW
• **AWWA C504 Butterfly Valves**
Available with many actuator options

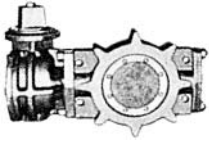

WAFER END -NUT
OPERATOR

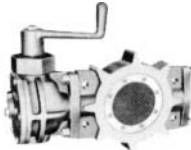

WAFER END -
CRANK OR
HANDWHEEL
OPERATOR

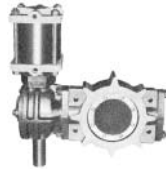

WAFER END -
CYLINDER
OPERATOR



WAFER END -
HAND LEVER

Five operators are available - underground 2"-square nut, crank or handwheel operated, cylinder operated, hand lever and electric-motor operated. All operators are permanently lubricated and totally enclosed.

**NEW, EXCLUSIVE CYLINDER
OPERATOR ASSURES EFFICIENT
OPERATION**

The M&H / CLOW cylinder is designed as an integral part of the operator. The cylinder model functions in a similar manner to the underground model except that the crosshead is attached permanently to the piston rod. Bronze bearings support the piston rod on both ends of the operator housing - minimize seal wear and eliminate the need for rubber hoses and swivel connections required by swinging, trunnion-mounted cylinders.

M&H / CLOW cylinder operators are compact - yet are sized to operate valves easily and surely, even under adverse operating conditions and low cylinder supply pressure.

Totally enclosed, permanently lubricated, the M&H / CLOW cylinder operator is completely protected from dirt and grit. Elimination of exposed moving parts provides extra safety for personnel and simplifies installation. Solenoid control and positioning accessories can be added easily to standard parts for remote operation.

FLOW CONTROL VALVE

Because of its unique operation mechanism, the M&H / CLOW Butterfly Valve is an excellent throttling valve. The threaded connection between the operating stem (1) and the crosshead (2) creates a self-locking action which prevents any undesired movement of the crosshead. This mechanism, in combination with the drive shaft, holds the vane firmly, without chatter, throughout travel.

100% Interchangeable. Feature of the M&H / CLOW Butterfly Valve is the complete interchangeability of operators. Each operator and all component parts are interchangeable on all valve bodies.

The vane is, in effect, "locked" in any desired position. The pointer of the operator plate clearly indicates the amount of vane opening.

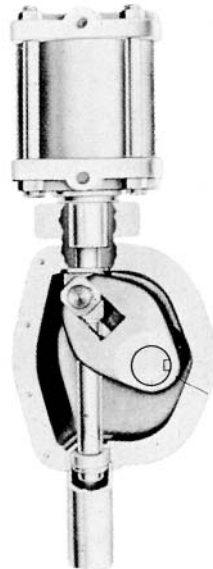

Cylinder Operator

STYLE	SIZE
4500	4"-24"

Working Pressure:
4" through 12" sizes - 200 psi
14" through 24" sizes - 150 psi
Hydrostatic Test Pressure:
4" through 12" sizes - 400 psi
14" through 24" sizes - 300 psi

M&H / CLOW 4500 AWWA C504 BUTTERFLY VALVES**• Comparison of Head Loss****• Pipe with and without Butterfly Valves at Different Velocities**

"I would like to install butterfly valves in my distribution system, but I don't see how you can get enough water past that vane - won't this mean that I'll need larger pipes or bigger pumps if I use your valve?"

The above question is a logical one, as the vane in the waterway of the butterfly valve appears to be a real obstacle to the flow of water in the line. Fortunately, this is not the case.

We have run tests to determine the head loss with the valve wide-open in various sizes of the M&H butterfly valves. These tests have shown that under normal flowing velocities, **the added pressure drop caused by the butterfly valve is so slight as to be immeasurable.**

For example -

A 12" line of standard cast iron pipe, 1,000 feet long has a Hazen-Williams coefficient "C" = 100. One end of the pipeline is connected to a reservoir.

If a pressure gauge is installed at the other end of the 1,000-feet, it will now show 78.20 psi at a flow of 1,000 gpm, indicating a drop of 1.80 psi due to the pipe.

If a 12" M&H / CLOW butterfly valve is now cut into the 1,000-foot line, with all other conditions unchanged, the same gauge will now show 78.16 psi, including a drop of 1.84 psi due to the pipe and valve together, or 0.04 drop due to the valve alone, (too slight to register) or equivalent to the addition of 25 feet of pipe to the 1,000-ft. line.

If a gate valve or full-area ball valve had been installed instead, the gauge would indicate a reading somewhere between 78.20 and 78.16 psi.

The above example is based on normal mild flow in a distribution line, with one valve installed at every two blocks (with no other fittings such as elbows, laterals, tees and crosses). If, say, twice as many butterfly valves were installed in the same line, the gauge would show 0.04 psi less - or 78.12 psi. These differences cannot even be detected on ordinary gauges.

At higher line velocities, the butterfly valve has increased loss, but always in the same ratio as the pipeline, elbows and other fittings. Again, the increased head loss due to use of butterfly valves in a normal distribution system is so slight that they can be installed with no more concern than is given to elbows, gate valves and other fittings. In fact, only when a very short line is under consideration (where the "Equivalent Feet of Pipe" of the butterfly valve represents a significant portion of the total length) is head loss in a wide open butterfly valve a factor. The insignificant head loss under normal circumstances is far outweighed by the operating benefits of butterfly valves:

- 1 - Ease of operation, in all sizes, even under line break conditions (By pass or auxiliary gear never required).
- 2 - Bottle-tight shutoff.
- 3 - No maintenance - no exercising.
- 4 - Low cost.
- 5 - Throttling ability without need of expensive modifications.

In the table on the next page, data has been tabulated to show pressures at the end of a section of pipeline without any valve, and with the M&H / CLOW 4500 butterfly valves installed. Compare these values for various sizes and flows. Remember - if gate valves are considered, pressure at end of line section will be between the values shown, and insignificantly higher than it would be with butterfly valves.

**M&H/CLOW BUTTERFLY VALVE
COMPARISON CHART (1000-FEET OF CIP) C = 100**

FLOW.GPM	PRESSURE AT RESERVOIR, PSI	PRESSURE AT END OF LINE SECTION, PSI	
		NO VALVE	BUTTERFLY VALVE
4" CAST IRON PIPE			
0	80	80	80
50	80	78.54	78.51
100	80	74.67	74.6
200	80	60.8	60.5
300	80	39.4	38.7
400	80	10.6	9.5
6" CAST IRON PIPE			
0	80	80	80
100	80	79.26	79.25
300	80	74.4	74.3
600	80	59.6	59.2
900	80	37.0	36.1
1,200	80	6.7	5.2
8" CAST IRON PIPE			
0	80	80	80
150	80	79.62	79.61
450	80	77.06	77.00
900	80	69.35	69.13
1,200	80	61.9	61.5
1,800	80	41.6	40.8
2,400	80	14.5	13.2
10" CAST IRON PIPE			
0	80	80	80
600	80	78.30	78.26
1,200	80	73.9	73.75
1,800	80	67.0	66.7
3,200	80	42.5	41.6
4,500	80	9.4	7.6
12" CAST IRON PIPE			
0	80	80	80
1,000	80	78.20	78.16
2,000	80	73.5	73.35
3,500	80	61.7	61.2
5,000	80	44.7	43.8
7,500	80	5.0	3.2

FLOW.GPM	PRESSURE AT RESERVOIR, PSI	PRESSURE AT END OF LINE SECTION, PSI	
		NO VALVE	BUTTERFLY VALVE
14" CAST IRON PIPE			
0	80	80	80
1,500	80	78.20	78.14
3,000	80	73.50	73.28
5,000	80	62.3	61.7
7,000	80	48.9	47.8
10,000	80	19.8	17.7
16" CAST IRON PIPE			
0	80	80	80
2,000	80	78.40	78.34
4,000	80	74.20	74.00
6,000	80	67.8	67.4
8,000	80	59.2	58.4
12,000	80	36.2	34.6
18" CAST IRON PIPE			
0	80	80	80
2,000	80	79.10	79.05
4,000	80	76.70	76.54
8,000	80	68.3	67.7
12,000	80	55.2	54.0
16,000	80	37.7	35.5
20" CAST IRON PIPE			
0	80	80	80
2,500	80	79.18	79.14
4,000	80	78.06	77.96
8,000	80	73.0	72.65
16,000	80	54.7	53.4
20,000	80	41.8	39.9
24" CAST IRON PIPE			
0	80	80	80
4,500	80	79.02	78.96
9,000	80	76.45	76.24
12,000	80	73.90	73.54
16,000	80	69.5	68.9
20,000	80	54.3	53.4

M&H / CLOW BFV

• All Styles
• Electric Motor Operator



Butterfly Valves may be furnished with electric operating units.

Motor operated valves are specified where frequent operation is necessary or where valves are located in remote, inaccessible or hazardous places.

For large valves and frequently used valves, operating costs are reduced and

efficiency increased by the remote control possible with electric motor operation. In emergencies, quick operation of valves by electric motor may be extremely vital.

Electric Motor Operated Valves are used in industrial plants, power plants, water plants, sewage disposal systems and miscellaneous pipe lines. Some of their specific uses include the following:

Large Valves	Storage Tanks
Intakes	Filter Beds
Outlets	Booster Stations
Pump Discharge	

An electric motor is mounted on the valve and geared to the valve stem so that when the motor operates the valve will open or close. Adjustable limit and torque switches are arranged to stop the motor when the valve is completely opened or closed, or automatically stop the motor if there is any obstruction in the valve to prevent the disc from moving. This prevents damage both to the valve parts and to the motor and gearing. Electric equipment conforms to N.E.M.A. codes. Detailed specifications on the construction and design of motor units and controls will be furnished if desired. Motors are high torque, fully enclosed in weatherproof or explosion-proof housings.

When specified, motors shall include:

- Integral reversing starter package which includes reversing controller, 120 volt/25 watt heater, 75 VA transformer with fused secondary & 24 point terminal strip. Available in weatherproof, explosion-proof etc. enclosures.
- Three button—two light push button station

for open, stop and close operation with red and green lights to show whether the valve is open or closed. The green light is lit when the valve is closed, the red light is lit when the valve is open. Both red and green lights remain lit when the valve disc is in any intermediate position between open and closed. Various combinations of buttons and lights are available as well as integral, surface or flush mounting in either weather-proof or explosion-proof enclosures.

- Mechanical dial position indicator available when specified for easy to read position of valve disc. Available for local, remote and local/remote indication.

Motor operating units are available with auxiliary handwheels for manual operation, which do not turn during electric operation. If the electric current comes on during manual operation, the handwheel of the unit declutches automatically and thus prevents any possible injury to the operator.

Information Required With Order

1. Valve size and quantity.
2. Type—BFV.
3. Modulating or non-modulating.
4. Maximum Pressure against which valve will be required to operate (Maximum Differential Pressure) and flow rate in feet/sec. if available.
5. Current Characteristics (Voltage, Phase, Cycles, A.C. or D.C.)
6. Opening or Closing time in seconds.
7. Service: Water, etc.
8. Frequency of service; regulating or intermittent duty.
9. Maximum temperature at location of valve control.
10. Type motor desired: Weatherproof, Explosion-proof, etc.
11. Type of Reversing Controller, (NEMA-Class).
12. Type of Push-button Station: (NEMA-Class) Normally NEMA-1 or NEMA-4) (Number of Push-buttons or Lights—Usually 3 buttons, 2 lights).
13. Control Voltage.
14. Any special requirements such as mechanical dial position indicator, hand off automatic switch on push button stations, etc.
15. Complete specifications will be required with inquiry for all motor valves.

M&H / CLOW 4500 4"-24"

- **AWWA Class 150-B Butterfly Valves; NSF Approved**
- **Suggested Specifications**
- **Butterfly Valves with Operator**
- **Specifications by Body Type & Operator**

A. GENERAL

All butterfly valves shall be of the rubber-seated tight-closing type. They shall meet or exceed AWWA Standard C504. All valves shall be M&H / CLOW 4500 butterfly valves, or approved equal.

Both valve ends shall be mechanical-joint (or other, as specified) per AWWA Standard C111. Accessories (bolts, glands, and gaskets) shall be supplied by the valve manufacturer.

All valves must use full AWWA C504 Class 150B valve shaft diameter, and full Class 150B underground-service-operator torque rating throughout entire travel, to provide capability for operation in emergency service. All valves shall be NSF approved.

B. VALVE

Valve body shall be high-strength cast iron ASTM A126 Class B with 18-8 Type 304 stainless steel body seat. Valve vane shall be high-strength cast iron ASTM A48 Class 40, having rubber seat mechanically secured with an integral 18-8 stainless steel clamp ring and 18-8 stainless steel self-locked screws.

Rubber seat shall be a full-circle 360 degree seat not penetrated by the valve shaft. For valves 4" - 12" the valve shaft shall be one piece, extending full size through the entire valve. Valve shaft shall be 304 stainless steel. Packing shall be O-ring cartridge designed for permanent duty in underground service. For 14" and larger valve shaft shall be 18-8 stainless steel stub shaft design keyed to the vane with stainless steel taper pins or torque plugs.

Body Type

All butterfly valves shall be of the rubber-seated tight-closing type. They shall meet or exceed AWWA Standard C504. All valves shall be M&H butterfly valves, or approved equal.

Valve ends shall be: (Select desired)

Wafer Type Body - Suitable for installation between 125# or 150# ANSI flanges (available 4" thru 20"). Note: Laying lengths not in accord with Table 2.

Flanged - short body valves per Table 2 of AWWA Spec C504. Flanges shall be 125# ANSI (available all sizes). Also flanged by MJ in 6", 8", 12" and 16" sizes.

Mechanical Joint - Both ends of valve shall be "MJ" per AWWA C111. "MJ" accessories (bolts, glands, gaskets) must be supplied by valve manufacturer. (Available all sizes - also flanged by MJ in 6", 8", 12" and 16" sizes.)

C. OPERATOR**Underground**

Valve operator shall be of the traveling-nut type, sealed, gasketed, and lubricated for underground service. It shall be capable of withstanding an overload input torque of 450 ft. lbs. at full-open or full-closed position without damage to the valve or valve operator. It shall be designed for submergence in water to 25 ft. head pressure for up to 72 hours. Number of turns to operate valve shall be as listed below in order to closely resemble conventional distribution valve practices; and to minimize water hammer. Operator shall have external adjusters.

Valve shall be capable of easy closure by one man using standard valve key, even under emergency line-break conditions as severe as those that would cause a valve maximum opening torque requirement of as much as two times AWWA Class 150B.

All valves shall open left (right), and be equipped with 2" AWWA operating nut, crank, handwheel or chainwheel.

All manual operators for service other than underground shall have position indicator and shall be totally enclosed and permanently lubricated. In any event, a maximum pull of 80 lbs. on the crank or wheel shall produce full Table 1 output torque throughout entire travel. Operators shall accept 450 lbs. input on crank or wheel at full-open and full-closed positions without damage to valve or operator. Operators shall be of the "Traveling-Nut" type. All valves shall open left (clockwise to close).

Cylinder - Cylinder operator shall be of the base mounted configuration. Cylinder barrel shall be of molybdenumdisulfide lined glass fiber reinforced epoxy tubing, to provide a corrosion-free, self-lubricated high strength barrel. Rod seal shall be of urethane, molybdenumdisulfide filled, to provide a self-lubricated, long life seal.

Piston rod shall be of hard chromium plated 18-8 stainless steel, and shall be top and bottom guided in a heavy cast iron mechanism housing for positive alignment. Guiding shall be accomplished by bronze bearings at ends of housing.

ASSEMBLY-STYLE 4500 SERIES FLANGED BUTTERFLY VALVE W/ LEVER OPERATOR

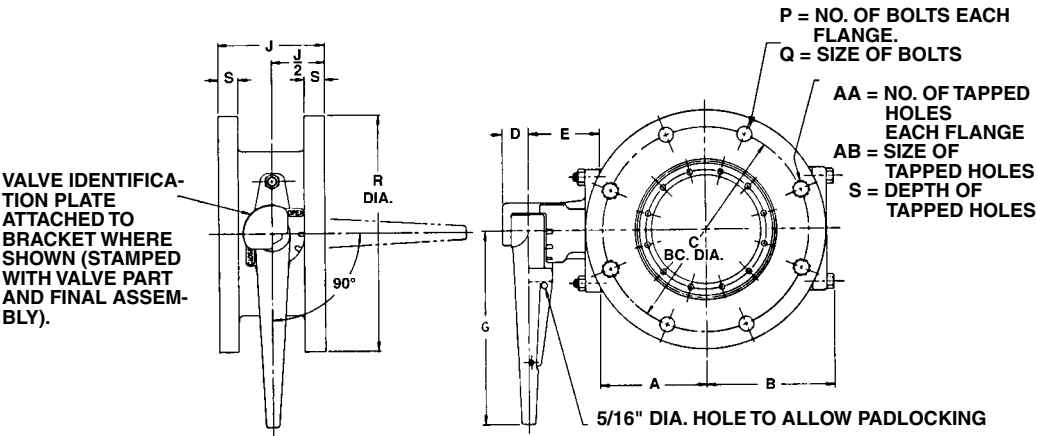

Notes: (1) Valve shaft will meet or exceed requirements of shaft table per AWWA standard C504 for applicable class.

(2) Flow may be in either direction.

With 125# A.N.S.I. flanges & drilling per AWWA C504

VALVE SIZE	A	B	C	J	P	Q	R	S	AA	AB
4"	4	5-7/16	7-1/2	5	8	5/8	9	15/16	4	5/8-11
6"	5	6-1/2	9-1/2	5	8	3/4	11	1	4	3/4-10
8"	6	7-9/16	11-3/4	6	8	3/4	13-1/2	1-1/8	4	3/4-10

VALVE SIZE	OPERATOR MODEL	D	E	G
4"	65	1-1/2	3-13/16	11
6"	150	1-1/2	3-13/16	11
8"	250	1-1/2	4-1/16	11

ASSEMBLY-STYLE 4500 SERIES MECHANICAL JOINT BFV W/ BURIED OPERATOR

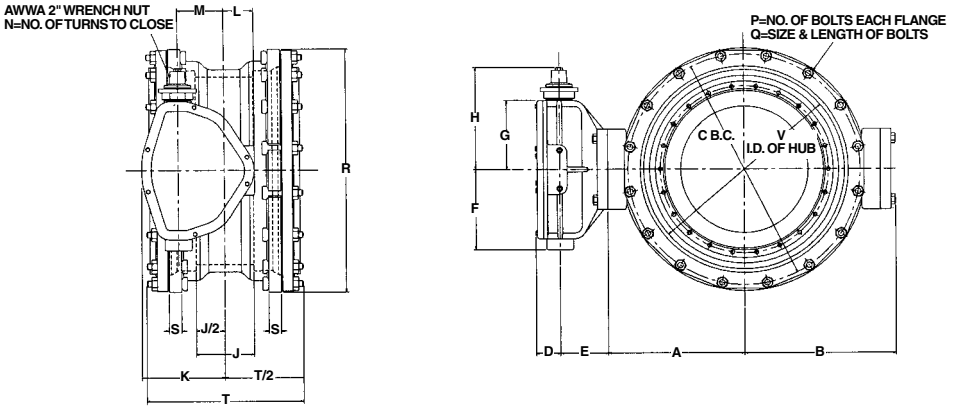

Note: Flow may be in either direction.

Gaskets, Glands & Bolts for mechanical joint are furnished with valve when specified on order.

Valve shaft will meet or exceed requirements of shaft table per AWWA standard C 504 for applicable class.

Reference AWWA STD. C 111 (A.N.S.I. A21-11)

VALVE SIZE	A	B	C	J	P	Q	R	S	T	V
4"	4	5-7/16	7-1/2	2-1/2	4	3/4X3 1/2	9-1/8	1	12-3/4	4.90
6"	5	6-1/2	9-1/2	2-7/8	6	3/4X3 1/2	11-1/8	1-1/16	13	7.00
8"	6	7-9/16	11-3/4	3	6	3/4X4	13-1/8	1-1/8	14	9.15
10"	7-3/4	9-5/8	14	4-1/4	8	3/4X4	15-11/16	1-3/16	15-1/8	11.20
12"	9-1/2	11-3/8	16-1/4	4-1/4	8	3/4X4	17-15/16	1-1/4	16	13.30
14"	10-7/16	12-15/16	18-3/4	5-1/4	10	3/4X4	20-5/16	1-5/16	17-5/8	15.44
16"	12-3/16	14-11/16	21	5-1/4	12	3/4X4 1/2	22-9/16	1-3/8	18-1/2	17.54
18"	13-5/16	15-13/16	23-1/4	6-1/8	12	3/4X4 1/2	24-13/16	1-7/16	19-1/4	19.64
20"	14-7/8	17-3/8	25-1/2	6-1/8	14	3/4X4 1/2	27-1/16	1-1/2	19-1/8	21.74
24"	17-19/32	20-1/8	30	7-1/2	16	3/4X5	31-9/16	1-5/8	21-1/4	25.94

VALVE SIZE	OPERATOR MODEL	D	E	F	G	H	K	L	M	N
4", 6" & 8"	150	2-15/16	3-9/16	3-7/16	3	7-3/4	3-7/16	2-1/4	1-3/8	16-1/2
10", 12" & 14"	510	3-3/16	4-1/2	5-7/16	5-3/16	10-1/16	6-1/8	2-3/4	3	36
16", 18" & 20"	1250	4-1/16	5-3/4	8-3/8	7	12-5/16	7-7/8	3-1/4	4	48
24"	2200	4-1/16	6-1/4	10-3/8	9	14-5/16	10-3/4	3-7/8	6	72

**ASSEMBLY-STYLE 4500 SERIES FLANGED
BFV W/ BURIED OPERATOR**

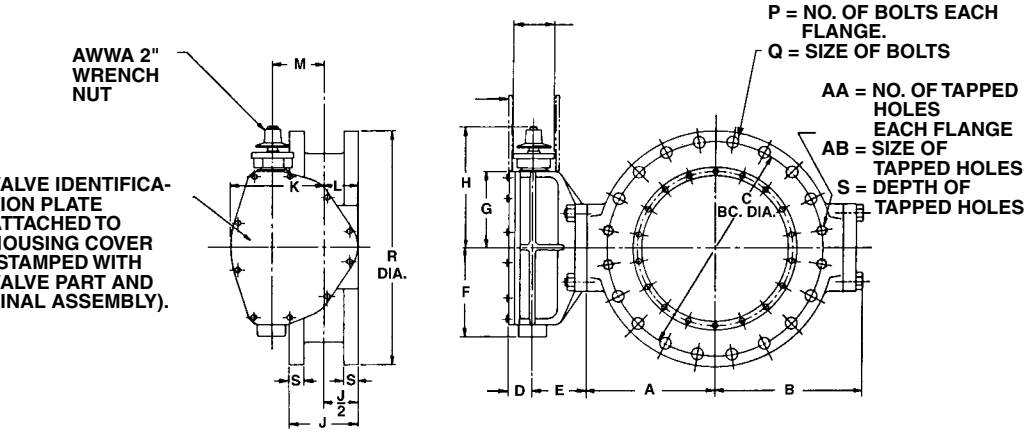

Note: Valve shaft will meet or exceed requirements of shaft table per AWWA standard C504 for applicable class.

Flow may be in either direction.

With 125# A.N.S.I. flanges & drilling per AWWA C504

VALVE SIZE	A	B	C	J	P	Q	R	S	AA	AB
4"	4	5-7/16	7-1/2	5	8	5/8	9	15/16	4	5/8-11
6"	5	6-1/2	9-1/2	5	8	3/4	11	1	4	3/4-10
8"	6	7-9/16	11-3/4	6	8	3/4	13-1/2	1-1/8	4	3/4-10
10"	7-3/4	9-5/8	14-1/4	8	12	7/8	16	1-3/16	-	-
12"	9-1/2	11-3/8	17	8	12	7/8	19	1-1/4	-	-
14"	10-7/16	12-15/16	18-3/4	8	12	1	21	1-3/8	4	1-8
16"	12-3/16	14-11/16	21-1/4	8	16	1	23-1/2	1-7/16	4	1-8
18"	13-5/16	15-13/16	22-3/4	8	16	1-1/8	25	1-9/16	4	1-1/8-7
20"	14-7/8	17-3/8	25	8	20	1-1/8	27-1/2	1-11/16	4	1-1/8-7
24"	17-19/32	20-1/8	29-1/2	8	20	1-1/4	32	1-7/8	4	1-1/4-7

M&H / CLOW AWWA C504 LARGE DIAMETER BUTTERFLY VALVES

• STYLE 1450 30"-48"

• *The dependable valve for water transmission and in-plant applications*

NSF APPROVED



M&H / CLOW Style 1450, Class 150B butterfly valve, 30"-48" size with mechanical joint ends or flanged and manual underground service operator.

Working Pressure-150 psi (Tested Bottle-tight)

Hydrostatic Test Pressure-300 psi

Available AWWA Classes-25A, 25B, 75A, 75B, 150A, 150B (**250 psi & class 250 flanged available**)

Size Range: 30", 36", 42", 48"

End Configurations: Flanged or Mechanical Joint

Operator: Available open left or open right on buried Operators. Above ground operators available: Handwheel, Cylinder and Electric Motor.

From the engineers who brought you the unequalled reliability and economy of the most widely installed underground butterfly valve ever—the M&H / CLOW "4500"—comes the Style 1450 Large Diameter Butterfly valve. The Style 1450 offers the many advantages of the time proved M&H / CLOW "4500"—ruggedness, bottle-tight seal, corrosion-free bearing and sealing surfaces, freedom from excessive maintenance—plus the added dimension of a "flow-through" vane.

Less Flow Restriction

The innovative design of the M&H / CLOW Style 1450 flow-through vane provides maximum free flow area without sacrificing vane strength. This greater flow through area results in less pressure drop and pumping costs than conventional designs.

Rubber-To-Stainless Seating Provides Bottle-Tight Permanent Closure.

The exclusive patented rubber vane-seat and 18-8 stainless steel valve-seat construction of the M&H /CLOW Style 1450 butterfly valve assures you of 100% bottle-tight sealing for the life of the valve. The stainless steel body seat ring is made integral with the valve body to assure a permanent, corrosion-resistant seating area. The vane seat is a special compound of Buna-S and natural rubber, firmly clamped to the vane by a stainless steel seat-retaining ring and stainless steel self-locking screw fasteners. This construction forms a positive lock between the vane and rubber seat, which assures 360° "bottle-tight" seating. The vane seat is adjustable and totally field replaceable, if required.

Operator shall produce full AWWA Standard C504 Table 1 output torque throughout entire travel for Class (25A) (25B) (75A) (150A) (150B).

COATING

Standard coating shall be Universal Primer. Coating shall be applied to entire valve body and vane before final assembly.

Epoxy (optional) shall be applied to all surfaces of valve body and vane to an average minimum film thickness of 5 to 8 mils, conforming to AWWA C550 Standard.

TESTS

All valves shall be tested bottle-tight at rated working pressure by the manufacturer as follows:

30" - 48" 150 psi seat test

300 psi hydrostatic test

CLASS 250 AVAILABLE

M&H / CLOW AWWA C504 LARGE DIAMETER STYLE 1450 30"-48" BUTTERFLY VALVES

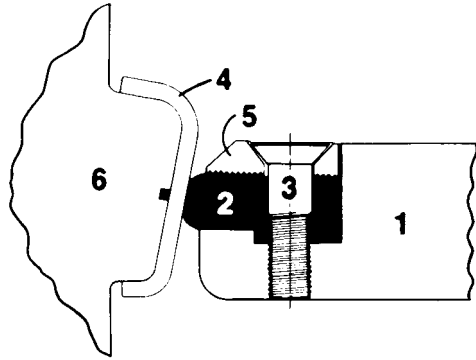

Every M&H / CLOW Style 1450 Butterfly Valve Undergoes Rigorous Quality Control And Pressure Tests To Assure Strict Conformance To Latest AWWA Standards Before Shipment.

UNIQUE ADJUSTABLE DESIGN ASSURES 360° UNINTERRUPTED SEALING

The M & H / CLOW Style 1450 incorporates a unique sealing system in which the seal is locked into a vane recess and is further restrained by a serrated 90° segmented clamp ring. Seal relaxation when the valve is in the open position is eliminated.

You are assured of uninterrupted 360° reliable and mechanically adjustable sealing as well as reduced wear and lower sealing torque. Should field adjustments be required, one man with a torque wrench does the job in minutes without valve disassembly.

1—Vane; 2—360° Rubber seat; 3—Stainless Steel Self-Locking Screw Fastener; with Nylon Sealing Sleeve; 4—Stainless Steel Body Seat Ring; 5—Stainless Steel Seat Retaining Ring; 6—Valve Body
Rugged Stainless Steel Shafts. All shafts are of 18-8 type stainless steel keyed for operator connection and pinned to the vane with stainless steel lock nuts...full metal to metal contact is assured with no leakage to shaft ways. M&H / CLOW Style 1450 shafts are manufactured to meet or exceed AWWA Standard C504. Shaft diameters are specified for the various valve classes.

Maintenance-Free. The M&H / CLOW Style 1450 butterfly valve is permanently lubricated and requires no periodic exercising or stem replacement. The closing action of the vane is self-cleaning and there are no pockets in which sediment formations can deposit, resulting in longer lifetime service.

The Style 1450 is supplied with O-Ring shaft seals contained in a bronze cartridge. Operators and end covers are permanently sealed against ground-water infiltration.

Working Parts Corrosion-Free. All critical bearing and sealing surfaces are stainless steel, rubber, bronze or Teflon*. Your assurance of long life, easy and efficient valve operation. Further protection can be afforded the M&H / CLOW Style 1450 with the added option of AWWA C550 EPOXY coating on interior valve surfaces. C550 coating provides effective protection from corrosion caused by tuberculation. When municipalities, consultants and contractors install the M&H / CLOW Style 1450 butterfly valve, they are making a sound investment for the future in dependable, maintenance-free service, bottle-tight sealing and long valve life. The M&H / CLOW Style 1450 will prove to set a new industry standard for large diameter butterfly valves. Contact your nearest M&H / CLOW field representative soon for complete details.

*DuPont Registered Trademark

NSF APPROVED



**M&H / CLOW STYLE 1450 BUTTERFLY VALVE
EXCLUSIVE FEATURES**

The cross section drawing below shows the design features and relative position of working parts of the M&H / CLOW Style 1450 butterfly valve.

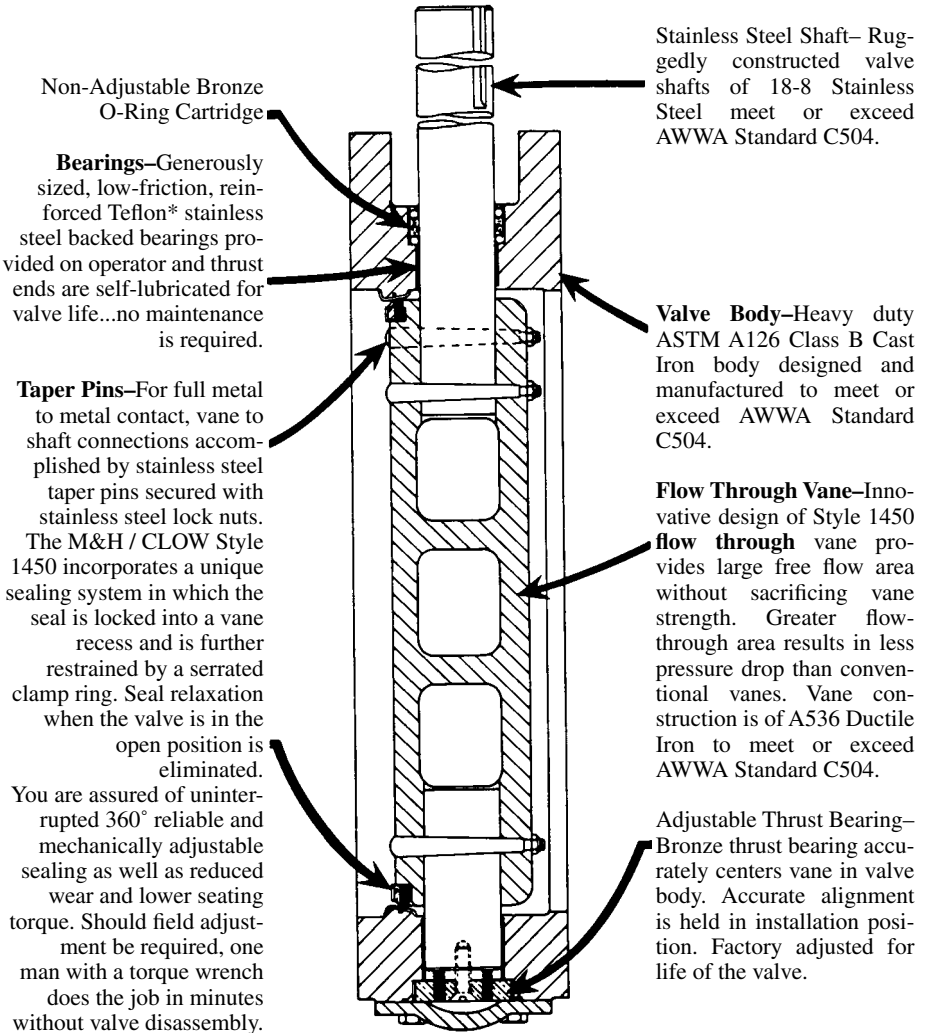

- 1- Vane;
 - 2- 360° Rubber Seat;
 - 3- Stainless Steel Self-Locking Screw Fastener; with Nylon Sealing Sleeve;
 - 4- Stainless Steel Body Seat Ring;
 - 5- Stainless Steel Seat Retaining Ring;
 - 6- Valve Body
- * DuPont Registered Trademark

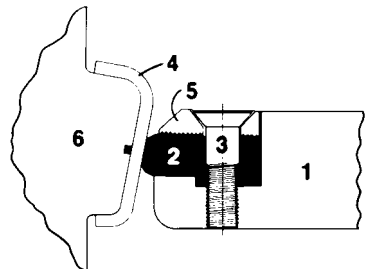

M&H / CLOW AWWA LARGE DIAMETER

- *Style 1450*
- *Butterfly Valves*
- *Suggested Specifications*
- *(30"-48")*
- *NSF Approved*

A. GENERAL

All Butterfly valves shall be of the rubber-sealed tight-closing type designed, manufactured and tested in conformance to AWWA Standard C504, latest revision. All valves shall be M&H / CLOW Style 1450 Butterfly Valves, or approved equal. NSF approval is recommended.

B. VALVE

Valve Body shall be high strength cast iron ASTM A126, Class B, with 18-8 Stainless Steel Body Seat. Valve Vane (Disc) shall be of ductile iron, ASTM A536, Grade 65-45-12 having rubber seat mechanically secured with a serrated 18-8 Stainless Steel Clamp Ring and 18-8 Stainless Steel self-locked screws. Rubber Seat shall be a full-circle 360° seat not penetrated by the valve shaft. The vane shall be of a "Flow-Through" design incorporating three integral flow passages, in order to provide low flow resistance and assurance of high quality. Valve shafts shall be of two-piece stub shaft type, made of 18-8 stainless steel with a diameter equal to or larger than specified for applicable valve class as defined by AWWA Standard C504, latest revision. Rubber Seats shall be capable of ready replacement or adjustment without the use of special tools. Shaft seals shall be of the "O-Ring" type.

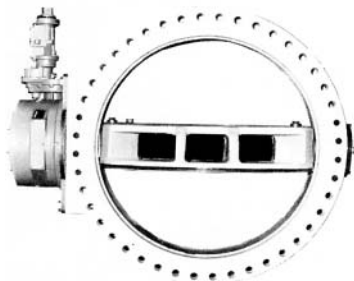

OPEN RIGHT VALVES CAN BE FURNISHED AS AN OPTION IF REQUIRED.

C. OPERATOR

The operator shall be of the traveling nut or worm gear type, self-locking in any position and sealed, gasketed and lubricated as needed.

All valves shall close by turning the operator nut or handwheel in a clock-wise direction (Open left). The operator shall be capable of meeting the torque requirements for opening and closing the valve against the pressure and flow rate specified.

For above-ground service, the operator shall provide position indication; and shall require no more than 80 pounds pull on the handwheel to provide necessary torque for specified pressure and flow rate.

Cylinder Operator shall meet all applicable provisions of AWWA Standard C504, latest revision.

D. END CONFIGURATIONS

Flanged-end valves shall be of the short-body type having 125# flanges conforming to ANSI B16.1. Mechanical joint end valves shall conform to AWWA Standard C111 (ANSI B21.11). Mechanical joint bolts, glands and gaskets (shall) (shall not) be supplied by the valve manufacturer. **Class 250 flanged available.**

E. TESTS

All valves shall be tested for leakage at rated pressure, and tested hydrostatically at two times rated pressure—all in conformance with AWWA Standard C504, latest revision.

Class 250 psi service available.

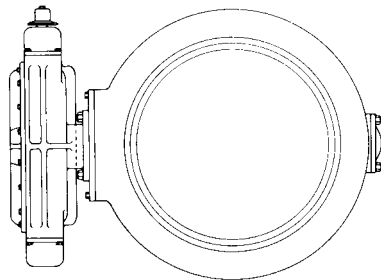

**ASSEMBLY - STYLE 1450 FLANGED BFV
HANDWHEEL AUMA ACTUATOR**
with 125# ANSI FLANGES & DRILLING PER AWWA C504

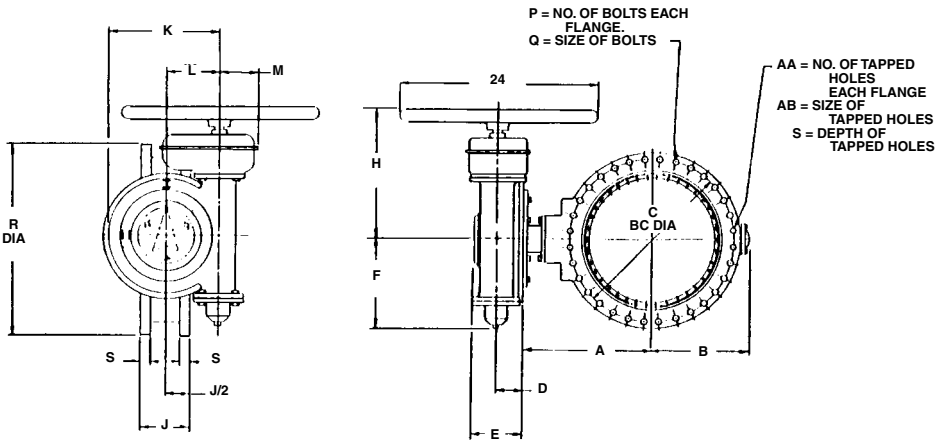

VALVE SIZE	A	B	C	J	P	Q	R	S	AA	AB
30"	21-5/8	21-3/8	36	12	28	1-1/4	38-3/4	2-1/8	4	1-1/4-7
36"	25-3/16	25-3/4	42	12	32	1-1/2	46	2-3/8	4	1-1/2-6
42"	29	28-7/8	49	12	36	1-1/2	53	2-3/8	4	1-1/2-6
48"	32	32	56	15	44	1-1/2	59	2-3/4	8	1-1/2-6

OPERATOR MODEL	D	E	F	H	K	L	M	N
GS 160/GZ 14	4	7-1/2	13-5/16	17-1/2	13-1/16	6-1/4	3-15/16	54
GS 200/GZ 16	5-1/8	9-1/4	15-11/16	20-5/8	16-3/4	7-7/8	4-1/2	53
GS 250/GZ 25	6-7/16	11-5/8	19-1/8	23-7/8	20-7/16	9-7/8	5-15/16	104
GS 315/GZ 30	7-1/16	13-3/8	24-1/16	28-5/8	25-3/4	12-7/16	9-7/16	212

Note: Valve shaft diameter will meet or exceed requirements of shaft table per AWWA standard C504 for applicable class.

Flow may be in either direction.

N=No. of turns to close.

**ASSEMBLY - 30"-48" BUTTERFLY VALVE
STYLE 1450 FLANGED ENDS
WITH HANDWHEEL OPERATOR
AWWA C504**

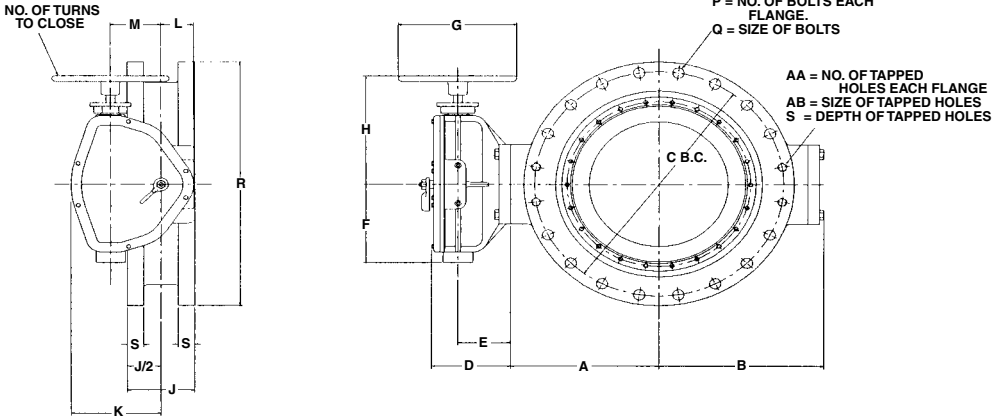

VALVE SIZE	A	B	C	J	P	Q	R	S	AA	AB
30"	20-5/8	21-5/8	36	12	28	1-1/4	38-3/4	2-1/8	4	1-1/4—7
36"	24-1/4	25-3/16	42-3/4	12	32	1-1/2	46	2-3/8	4	1-1/2—6
42"	28-1/4	28-7/8	49-1/2	12	36	1-1/2	53	2-5/8	4	1-1/2—6
48"	31-1/8	32	56	15	44	1-1/2	59-1/2	2-3/4	8	1-1/2—6

OPERATOR MODEL	D	E	F	G	H	K	L	M	N
2200	10-5/16	6-1/4	10-3/8	18	14-1/2	10-3/4	3-7/8	6	72
4350	11-5/16	6-1/16	15-1/8	27	18	13-5/16	4-3/16	7-1/2	90

- Notes:**
1. Flow may be in either direction.
 2. Valve shaft will meet or exceed requirements of shaft table per AWWA standard C504 for applicable class.
 3. Reference AWWA C504 flanges & drilling (ANSI 125).

**ASSEMBLY - STYLE 1450 M.J. BFV W/AUMA
BURIED ACTUATOR
AWWA STD. C111 (ANSI A21-11)**

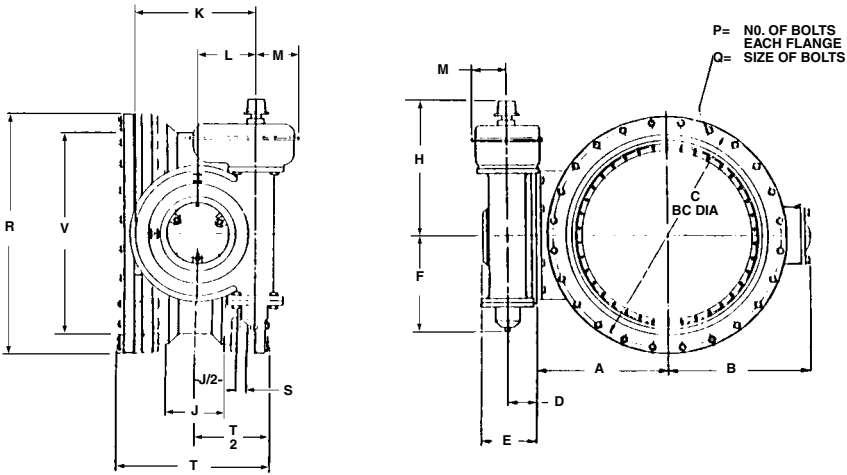

VALVE SIZE	A	B	C	J	P	Q	R	S	T	V
30"	20-5/8	21-5/8	36-7/8	12	20	1	39-1/8	1-13/16	28-3/8	32.17
36"	24-1/4	25-1/2	43-3/4	12	24	1	46	2	28-3/8	38.47
42"	28-1/4	28-7/8	50-5/8	12	28	1-1/4	53-1/8	2	28-3/8	44.67
48"	31-1/8	32	57-1/2	15	32	1-1/4	60	2	31-3/8	50.97

OPERATOR MODEL	D	E	F	H	K	L	M	N
GS 160/GZ 14	4	7-1/2	13-15/16	17-1/2	13-1/16	6-1/4	3-15/16	54
GS 200/GZ 16	5-1/8	9-1/4	15-11/16	20-5/8	16-3/4	7-7/8	4-1/2	53
GS 250/GZ 25	6-7/16	11-5/8	19-1/8	23-7/8	20-7/16	9-7/8	5-15/16	104
GS 315/GZ 30	7-1/16	13-3/8	24-1/16	28-5/8	25-3/4	12-7/16	9-7/16	212

Note: Valve shaft diameter will meet or exceed requirements of shaft table per AWWA standard C504 for applicable class.

Flow may be in either direction.

N=No. of turns to close.

**STYLE 2450 "RUBBER IN THE BODY" BUTTERFLY VALVE
AWWA C504**

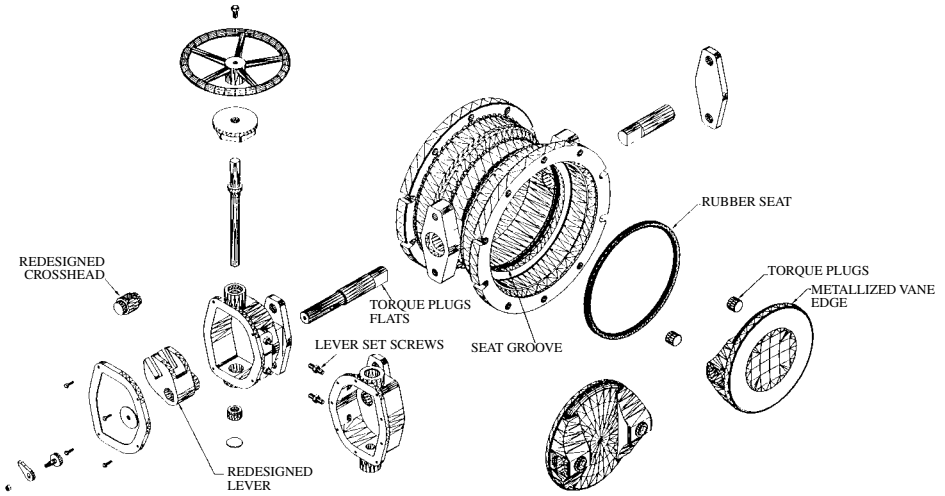

**BUTTERFLY VALVE STYLE 2450
AWWA C504**

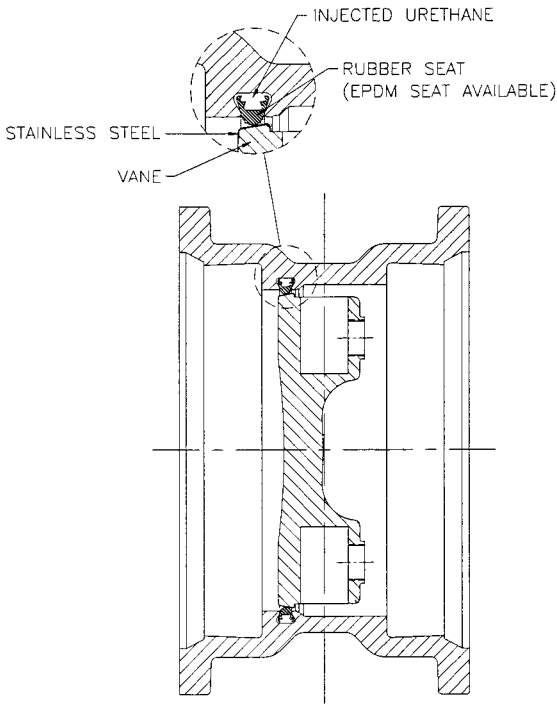

**ASSEMBLY - 4"-24" BUTTERFLY VALVE
STYLE 2450 FLANGED ENDS
WITH HANDWHEEL OPERATOR
AWWA C504**

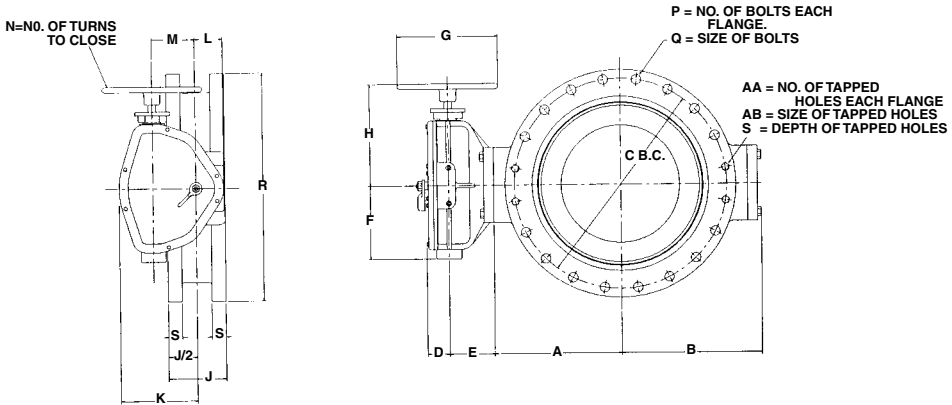

VALVE SIZE	A	B	C	J	P	Q	R	S	AA	AB
4"	4	5-7/16	7-1/2	5	8	5/8	9	15/16	4	5/8-11
6"	5	6-1/2	9-1/2	5	8	3/4	11	1	4	3/4-10
8"	6	7-9/16	11-3/4	6	8	3/4	13-1/2	1-1/8	4	3/4-10
10"	7-3/4	9-5/8	14-1/4	8	12	7/8	16	1-3/16	-	-
12"	9-1/2	11-3/8	17	8	12	7/8	19	1-1/4	-	-
14"	10-7/16	12-15/16	18-3/4	8	12	1	21	1-3/8	4	1-8
16"	12-3/16	14-11/16	21-1/4	8	16	1	23-1/2	1-7/16	4	1-8
18"	13-5/16	15-13/16	22-3/4	8	16	1-1/8	25	1-9/16	4	1-1/8-7
20"	14-7/8	17-3/8	25	8	20	1-1/8	27-1/2	1-11/16	4	1-1/8-7
24"	17-19/32	20-1/8	29-1/2	8	20	1-1/4	32	1-7/8	4	1-1/4-7

VALVE SIZE	OPERATOR MODEL	D	E	F	G	H	K	L	M	N
4", 6" & 8"	150	2-15/16	3-9/16	3-7/16	7-1/2	7-3/4	3-7/16	2-1/4	1-3/8	16-1/2
10", 12" & 14"	510	3-3/16	4-1/2	5-7/16	12	10-3/16	6-1/8	2-3/4	3	36
16", 18" & 20"	1250	4-1/16	5-3/4	8-3/8	18	12-1/2	7-7/8	3-1/4	4	48
24"	2200	4-1/16	6-1/4	10-3/8	18	14-1/2	10-3/4	3-7/8	6	72

- Notes:**
- Flow may be in either direction.
 - Valve shaft will meet or exceed requirements of shaft table per AWWA standard C504 for applicable class.
 - Reference AWWA C504 flanges & drilling (ANSI 125).

**ASSEMBLY - 4"-24" BUTTERFLY VALVE
STYLE 2450 FLANGED ENDS
WITH BURIED OPERATOR
AWWA C504**

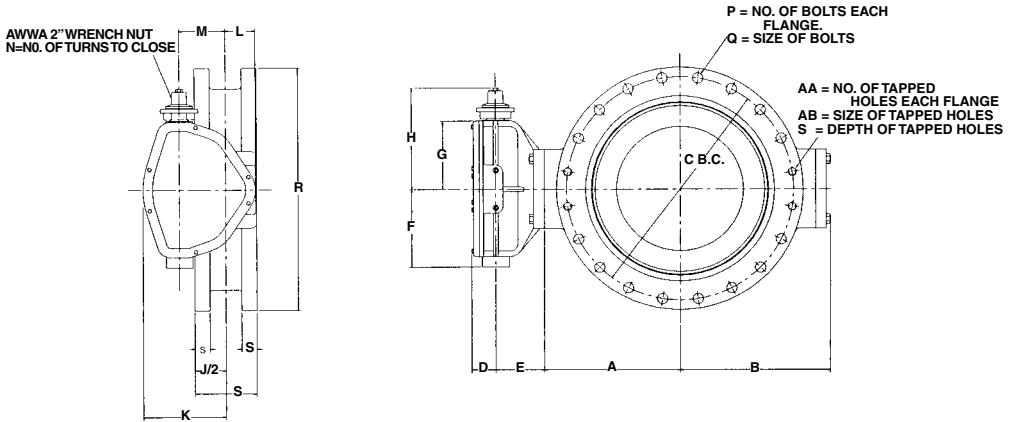

VALVE SIZE	A	B	C	J	P	Q	R	S	AA	AB
4"	4	5-7/16	7-1/2	5	8	5/8	9	15/16	4	5/8-11
6"	5	6-1/2	9-1/2	5	8	3/4	11	1	4	3/4-10
8"	6	7-9/16	11-3/4	6	8	3/4	13-1/2	1-1/8	4	3/4-10
10"	7-3/4	9-5/8	14-1/4	8	12	7/8	16	1-3/16	-	-
12"	9-1/2	11-3/8	17	8	12	7/8	19	1-1/4	-	-
14"	10-7/16	12-15/16	18-3/4	8	12	1	21	1-3/8	4	1-8
16"	12-3/16	14-11/16	21-1/4	8	16	1	23-1/2	1-7/16	4	1-8
18"	13-5/16	15-13/16	22-3/4	8	16	1-1/8	25	1-9/16	4	1-1/8-7
20"	14-7/8	17-3/8	25	8	20	1-1/8	27-1/2	1-11/16	4	1-1/8-7
24"	17-19/32	20-1/8	29-1/2	8	20	1-1/4	32	1-7/8	4	1-1/4-7

VALVE SIZE	OPERATOR MODEL	D	E	F	G	H	K	L	M	N
4", 6" & 8"	150	2	3-9/16	3-7/16	3	7-3/4	3-7/16	2-1/4	1-3/8	16-1/2
10", 12" & 14"	510	2-1/4	4-1/2	5-7/16	5-3/16	10-1/16	6-1/8	2-3/4	3	36
16", 18" & 20"	1250	3-3/16	5-3/4	8-3/8	7	12-5/16	7-7/8	3-1/4	4	48
24"	2200	3-3/16	6-1/4	10-3/8	9	14-5/16	10-3/4	3-7/8	6	72

- Notes:**
1. Flow may be in either direction.
 2. Valve shaft will meet or exceed requirements of shaft table per AWWA standard C504 for applicable class.
 3. Reference AWWA C504 flanges & drilling (ANSI 125).

**ASSEMBLY - 4"-24" BUTTERFLY VALVE
STYLE 2450 MECHANICAL JOINT ENDS
WITH BURIED OPERATOR
AWWA C504**

AWWA 2" WRENCH NUT
N=NO. OF TURNS TO CLOSE

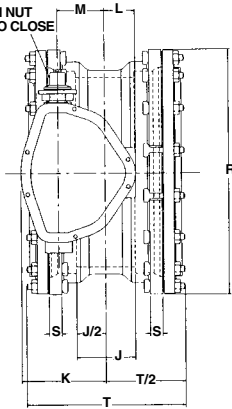

P = NO. OF BOLTS EACH
FLANGE.
Q = SIZE OF BOLTS

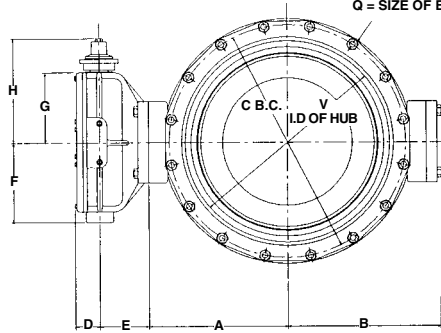

VALVE SIZE	A	B	C	J	P	Q	R	S	T	V
4"	4	5-7/16	7-1/2	2-1/2	4	3/4x3-1/2	9-1/8	1	12-3/4	4.90
6"	5	6-1/2	9-1/2	2-7/8	6	3/4x3-1/2	11-1/8	1-1/16	13	7.00
8"	6	7-9/16	11-3/4	3	6	3/4x4	13-1/8	1-1/8	14	9.15
10"	7-3/4	9-5/8	14	4-1/4	8	3/4x4	15-11/16	1-3/16	15-1/8	11.20
12"	9-1/2	11-3/8	16-1/4	4-1/4	8	3/4x4	17-15/16	1-1/4	16	13.30
14"	10-7/16	12-15/16	18-3/4	5-1/4	10	3/4x4	20-5/16	1-5/16	17-5/8	15.44
16"	12-3/16	14-11/16	21	5-1/4	12	3/4x4-1/2	22-9/16	1-3/8	18-1/2	17.54
18"	13-5/16	15-13/16	23-3/4	6-1/8	12	3/4x4-1/2	24-13/16	1-7/16	19-1/4	19.64
20"	14-7/8	17-3/8	25-1/2	6-1/8	14	3/4x4-1/2	27-1/16	1-1/2	19-1/8	21.74
24"	17-19/32	20-1/8	30	7-1/2	16	3/4x5	31-9/16	1-5/8	21-1/4	25.94

VALVE SIZE	OPERATOR MODEL	D	E	F	G	H	K	L	M	N
4", 6" & 8"	150	2-15/16	3-9/16	3-7/16	3	7-3/4	3-7/16	2-1/4	1-3/8	16-1/2
10", 12" & 14"	510	3-3/16	4-1/2	5-7/16	5-3/16	10-1/16	6-1/8	2-3/4	3	36
16", 18" & 20"	1250	4-1/16	5-3/4	8-3/8	7	12-5/16	7-7/8	3-1/4	4	48
24"	2200	4-1/16	6-1/4	10-3/8	9	14-5/16	10-3/4	3-7/8	6	72

- Notes:**
1. Flow may be in either direction.
 2. Gaskets, glands & bolts for mechanical joint are furnished with valve when specified on order.
 3. Valve shaft will meet or exceed requirements of shaft table per AWWA standard C504 for applicable class.
 4. Reference AWWA Std. C111 (ANSI A21-11).

**ASSEMBLY - 30"-48" BUTTERFLY VALVE
STYLE 2450 FLANGED ENDS
WITH BURIED OPERATOR
AWWA C504**

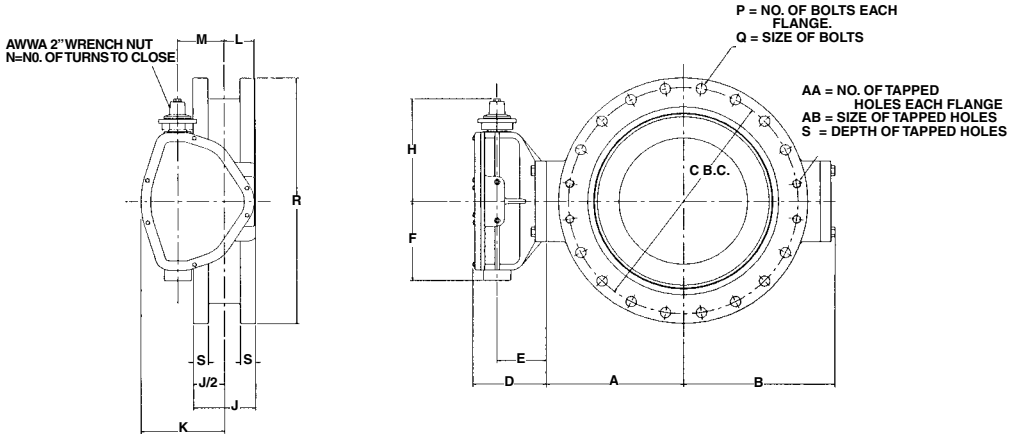

VALVE SIZE	A	B	C	J	P	Q	R	S	AA	AB
30"	20-5/8	21-5/8	36	12	28	1-1/4	38-3/4	2-1/8	4	1-1/4—7
36"	24-1/4	25-3/16	42-3/4	12	32	1-1/2	46	2-3/8	4	1-1/2—6
42"	28-1/4	28-7/8	49-1/2	12	36	1-1/2	53	2-5/8	4	1-1/2—6
48"	31-1/8	32	56	15	44	1-1/2	59-1/2	2-3/4	8	1-1/2—6

OPERATOR MODEL	D	E	F	H	K	L	M	N
2200	10-5/16	6-1/4	10-3/8	14-1/2	10-3/4	3-7/8	6	72
4350	11-5/16	6-1/16	15-1/8	18	13-5/16	4-3/16	7-1/2	90

- Notes:**
1. Flow may be in either direction.
 2. Valve shaft will meet or exceed requirements of shaft table per AWWA standard C504 for applicable class.
 3. Reference AWWA C504 flanges & drilling (ANSI 125).

**ASSEMBLY - 30"-48" BUTTERFLY VALVE
STYLE 2450 MECHANICAL JOINT ENDS
WITH BURIED OPERATOR
AWWA C504**

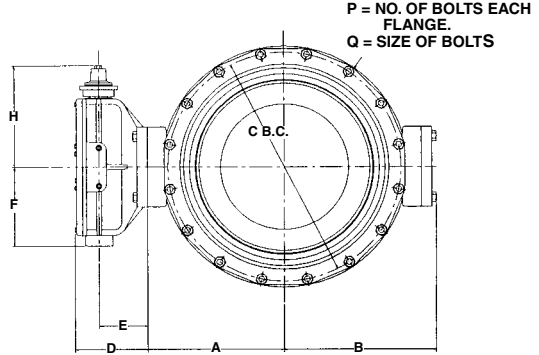
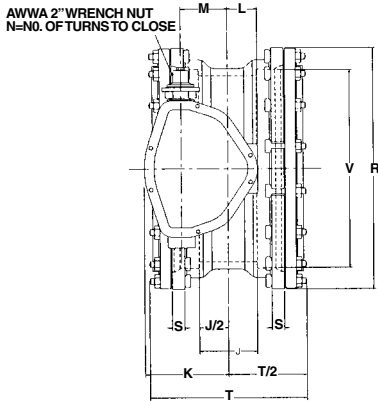

VALVE SIZE	A	B	C	J	P	Q	R	S	T	V
30"	20-5/8	21-5/8	36-7/8	12	20	1	39-1/8	1-13/16	28-3/8	32.17
36"	24-1/4	25-1/2	43-3/4	12	24	1	46	2	28-3/8	38.47
42"	28-1/4	28-7/8	50-5/8	12	28	1-1/4	53-1/8	2	28-3/8	44.67
48"	31-1/8	32	57-1/2	15	32	1-1/4	60	2	31-3/8	50.97

OPERATOR MODEL	D	E	F	H	K	L	M	N
2200	9-1/16	6-1/4	10-3/8	14-1/2	10-3/4	3-7/8	6	72
4350	10-1/16	6-1/16	15-1/8	18	13-5/16	4-3/16	7-1/2	90

- Notes:**
1. Flow may be in either direction.
 2. Gaskets, gland & bolts for mechanical joint are furnished with valve when specified on order.
 3. Valve shaft will meet or exceed requirements of shaft table per AWWA standard C504 for applicable class.
 4. Reference AWWA STD. C 111 (ANSI A21-11).

SECTION IV. VALVES
INDEX

Note: Unless otherwise specified by a particular item, items noted are available from Clow Valve, Kennedy Valve and M&H Valve.

A

Applicable Standards for Valves (ANSI/AWWA Standards)	223
--	-----

B

Bench Stands	187
Butterfly Valves:	
Electric Motor Operator Option	198
Grooved End-UL/FM	180, 182, 183
Style 4500 AWWA C504 - 4" - 24", M&H and Clow:	
Actuator Options	195
Assembly Flanged with Buried Operator	202
Assembly Flanged with Lever Operator	200
Assembly M.J. with Buried Operator	201
Description, Benefits and Features	192, 194
Ends Available	193
Head Loss Comparison	196, 197
Suggested Specifications	199
Style 1450 AWWA C504 - 30"-48", M&H and Clow:	
Assembly with Buried Actuator	209
Assembly with Handwheel Actuator	207
Assembly with Handwheel Operator	208
Description, Benefits and Features	203-205
Suggested Specifications	206
Style 2450 AWWA C504, M&H and Clow:	
Assembly 30"-48" Flanged with Buried Operator	214
Assembly 30"-48" M.J. with Buried Operator	215
Assembly 4"-24" Flanged with Handwheel Operator	211
Assembly 4"-24" Flanged with Buried Operator	212
Assembly 4"-24" MJ with Buried Operator	213
Part Drawing	210
Wafer	181
By-Pass Valves	156, 159

C

Chain Wheels	189
Check Valves:	
Cushion Check Valve	179
Grooved Check Valves, Kennedy	177, 178
Increasing Type Check Valve:	
With Lever and Weight	173
With Spring and Lever	174
Swing Check Valves	170-172
Cushion Check Valve	179
Cutting-In Valve	153, 159

D

Double Disc Gate Valves:	
Description and Advantages	148
Dimensions and Inches	149, 150

Gearing, Gear Cases and Position Indicators	157, 159
Operation and Construction	148
Ordering Information	159
Rollers, Tracks and Scrapers	158
Underwriters and Factory Mutual Valves	152, 159

E

Eccentric Plug Valves, Clow	161, 162
Extra Heavy Pressure Gate Valves - List 16	154, 155, 159

F

Flap Valves	185
Floor and Bench Stands	187
Floor Boxes	189
Floor Stand Arrangements	188

G

Gate Valves (See Double Disc, Extra Heavy Pressure, Metropolitan or Resilient Wedge)	
Gearing for Double Disc Gate Valves	157, 159
Grooved Check Valve - Kennedy	177, 178

I

Increasing Type Check Valves:	
With Lever and Weight	173
With Spring and Lever	174
Indicator Posts, Clow and Kennedy:	
Description	163
Flanged Base Post Indicator	164
Product Data Sheet	169
Style 2945 Fixed Length	167
Telescoping Barrel	166
Trench Depths for Gate Valves	168
Wall Posts	165

M

McWane, Inc. Division Offices	i
Metropolitan Gate Valve, NRS Style 1067, M&H:	
Description	146
Ordering Information	159
Specifications	147
Mud Valves	184

O

Ordering Information	
(See Valve being ordered for applicable page #)	

P

Pressure Relief Valves - Floor Type	190
Pressure Relief Valves - Wall Type	191

R

Ransom Industries, Inc. Division Offices	i
Resilient Wedge Valves:	
Available End Connections 2"-12"	142
Available End Connections 14"-24"	143

Description of Valve	141
Ordering Information	159
Recommended Specifications	145
Underwriters and Factory Mutual Valves	144, 159
Rollers, Tracks and Scrapers for Double Disc Gate Valves	158, 159

S

Shear Gates, M&H and Clow	186
Silent Check Valves	160
Stem Guides	189
Swing Check Valve:	
Dimensional Data	171
History and Description	170
Rubber Faced - Flanged End	172
Underwriters and Factor Mutual Valves:	
Description	175
Dimensional Data	176

T

Tapping Valves	151, 159
Terms	ii

W

Warranty	ii
Williams-Hager Silent Check Valves, Clow	160

TECHNICAL DATA

This page intentionally left blank.

PIPE
ECONOMY

CONTENTS

Applicable Standards Covering McWane, Inc. and Ransom Industries, Inc. Products	231
Ductile Iron Pipe Deflection Data	232
Rated Working Pressure and Maximum Depth of Cover	233
Thicknesses Required for Different Tap Sizes	234
Template for Drilling Flanges	237
Dimensions of Gaskets, Bolts and Studs	238
Flow of Water in Ductile Iron Pipe	240
Equation of Pipe	242
Contents of Pipe	243
Conversion Factors	244
Properties of Numbers	247
Linear Expansion of Ductile Iron Pipe	249
Frost Penetration Chart	250

This page intentionally left blank.

PIPE
ECONOMY

APPLICABLE STANDARDS COVERING MCWANE, INC. & RANSOM INDUSTRIES, INC. PIPE, FITTINGS, VALVES, HYDRANTS AND SPECIAL PRODUCTS

The following standards are those in force at the time of publication of this catalog. McWane, Inc. and Ransom Industries, Inc. products are always produced to the requirements of the most current revisions of governing standards.

DUCTILE IRON PIPE AND FITTINGS

PRODUCT	STANDARD DESIGNATION AND TITLE
DUCTILE IRON PRESSURE PIPE - DESIGN	ANSI/AWWA C150/A21.50: THICKNESS DESIGN OF DUCTILE IRON PIPE.
DUCTILE IRON PRESSURE PIPE FOR WATER	ANSI/AWWA C151/A21.51: DUCTILE IRON PIPE, CENTRIFUGALLY CAST FOR WATER OR OTHER LIQUIDS.
DUCTILE IRON FLANGED PIPE	ANSI/AWWA C115/A21.15: FLANGED DUCTILE IRON PIPE WITH DUCTILE OR GRAY IRON THREADED FLANGES.
DUCTILE IRON CULVERT PIPE	ASTM A716 STANDARD SPECIFICATION FOR DUCTILE IRON CULVERT PIPE.
DUCTILE IRON SEWER PIPE	ASTM A746 STANDARD SPECIFICATION FOR DUCTILE IRON GRAVITY SEWER PIPE.
GRAY AND DUCTILE IRON FITTINGS FOR WATER (FULL BODY)	AWWA C110/A21.10: GRAY-IRON AND DUCTILE IRON FITTINGS, 3 IN. THROUGH 48 IN., FOR WATER AND OTHER LIQUIDS.
COMPACT DUCTILE IRON FITTINGS	ANSI/AWWA C153/A21.53: DUCTILE IRON COMPACT FITTINGS, 3" THROUGH 24" FOR WATER SERVICE.
JOINTS FOR PIPE AND FITTINGS	ANSI/AWWA C111/A21.11: RUBBER-GASKET JOINTS FOR DUCTILE IRON PRESSURE PIPE AND FITTINGS.
CEMENT MORTAR LINING	ANSI/AWWA C104/A21.4: CEMENT-MORTAR LINING FOR DUCTILE IRON PIPE AND FITTINGS FOR WATER.
POLYETHYLENE ENCASEMENT	ANSI/AWWA C105/A21.5: POLYETHYLENE ENCASEMENT FOR DUCTILE IRON PIPE SYSTEMS.
INSTALLATION AND TESTING	ANSI/AWWA C600: INSTALLATION OF DUCTILE IRON WATER MAINS AND THEIR APPURTENANCES.

VALVES AND HYDRANTS

PRODUCT	STANDARD DESIGNATION AND TITLE
AWWA GATE VALVES	AWWA C500: 3" THROUGH 48" GATE VALVES
DRY-BARREL FIRE HYDRANTS	AWWA C502: DRY-BARREL FIRE HYDRANTS
WET-BARREL FIRE HYDRANTS	AWWA C503: WET-BARREL FIRE HYDRANTS
BUTTERFLY VALVES	AWWA C504: RUBBER SEATED BUTTERFLY VALVES
SWING CHECK VALVES	AWWA C508: SWING CHECK VALVES FOR ORDINARY WATERWORKS SERVICE
CLOW R/W, KENNEDY KEN-SEAL AND M & H RSGV GATE VALVES	AWWA C509: RESILIENT SEATED GATE VALVES-3" THROUGH 12"
LINING FOR VALVES AND HYDRANTS	AWWA C550: PROTECTIVE INTERIOR COATINGS FOR VALVES AND HYDRANTS
CLOW SILENT CHECK VALVES	ANSI FCI-74: SPRING LOADED LIFT DISC CHECK VALVES

**DUCTILE IRON PIPE DEFLECTION DATA
USEFUL TABLES**



The tables below provide data for determining the amount of deflection permitted in varying distances for a given pipe line.

TABLE I
Push-On Joint Pipe Deflection In Inches

	PIPE SIZE—INCHES												
	3	4	6	8	10	12	14	16	18	20	24	30	36
Y-MAXIMUM DEFLECTION-DEGREES	5°	5°	5°	5°	5°	5°	3°	3°	3°	3°	3°	3°	3°
X-DEFLECTION IN INCHES—18 FT. LENGTH	21*	21*	19	19	19	19	11	11	11	11	11	11	11

* 20 ft. lengths

APPROXIMATE RADIUS IN FEET OF CURVE PRODUCED BY SUCCESSION OF JOINTS 18 FEET LENGTH												
230*	230*	205	205	205	205	340	340	340	340	340	340	340
3"	4"	6"	8"	10"	12"	14"	16"	18"	20"	24"	30"	36"

* 20 ft. lengths

TABLE II
Maximum Deflection of Ductile Iron Pipe**

TYPE OF PIPE JOINT	PIPE SIZE—INCHES												
	3	4	6	8	10	12	14	16	18	20	24	30	36
PUSH-ON	5°	5°	5°	5°	5°	5°	3°	3°	3°	3°	3°	3°	3°
MECHANICAL JOINT	8°-18'	8°-18'	7°-7'	5°-21'	5°-21'	5°-21'	3°-35'	3°-35'	3°-0'	3°-0'	2°-23'
RESTRAINED JOINT	4°	4°	4°	4°	3°	3°	3°	3°	3°	2°	2°
RIVER CROSSING	15°	15°	15°	15°	15°	15°	15°	15°	15°	15°	15°

**Sound engineering dictates that to accommodate unknown field conditions, the “design” deflection of any joint be limited to 80 percent of the maximum value shown in the table above.

TABLE III
The Deflection of Pipe in Feet for Different Angles of Deflection and Number of Lengths of Pipe

TOTAL LENGTH OF PIPE IN FEET	NUMBER OF LENGTHS OF PIPE	DEGREES OF DEFLECTION PER JOINT							
		1°	2°	3°	4°	5°	6°	12°	15°
18	1	.31	.63	.94	1.26	1.57	1.88	3.74	4.66
36	2	.94	1.88	2.82	3.76	4.69	5.62	11.06	13.66
54	3	1.88	3.77	5.64	7.50	9.35	11.19	21.64	26.39
72	4	3.14	6.27	9.38	12.47	15.51	18.51	35.02	41.96
90	5	4.71	9.40	14.04	18.62	23.12	27.51	50.61	59.36
108	6	6.59	13.14	19.60	25.94	32.12	38.09	67.73	...
126	7	8.79	17.49	26.05	34.39	42.44	50.13	85.63	...
144	8	11.29	22.45	33.37	43.93	54.01	63.51
162	9	14.11	28.02	41.54	54.51	66.74	78.07
180	10	17.23	34.17	50.54	66.08	80.53	93.66
APPROX. RADIUS IN FEET OF CURVE PRODUCED BY A SUCCESSION OF JOINTS		1034	514	343	258	206	172	86	68
APPROX. NUMBER OF 18 FOOT LENGTHS OF PIPE REQUIRED TO MAKE A 90 DEGREE BEND		90	45	30	23	18	15	8	6

**TABLE 51.3 RATED WORKING PRESSURE
AND MAXIMUM DEPTH OF COVER***

SIZE IN.	PRESSURE† CLASS PSI	NOMINAL THICKNESS IN.	LAYING CONDITION				
			TYPE 1 TRENCH	TYPE 2 TRENCH	TYPE 3 TRENCH	TYPE 4 TRENCH	TYPE 5 TRENCH
			MAXIMUM DEPTH OF COVER IN FT.++				
3	350	0.25	78	88	99	100§	100§
4	350	0.25	53	61	69	85	100§
6	350	0.25	26	31	37	47	65
8	350	0.25	16	20	25	34	50
10	350	0.26	11**	15	19	28	45
12	350	0.28	10**	15	19	28	44
14	250	0.28	††	11**	15	23	36
	300	0.30	††	13	17	26	42
	350	0.31	††	14	19	27	44
16	250	0.30	††	11**	15	24	34
	300	0.32	††	13	17	26	39
	350	0.34	††	15	20	28	44
18	250	0.31	††	10**	14	22	31
	300	0.34	††	13	17	26	36
	350	0.36	††	15	19	28	41
20	250	0.33	††	10	14	22	30
	300	0.36	††	13	17	26	35
	350	0.38	††	15	19	28	38
24	200	0.33	††	8**	12	17	25
	250	0.37	††	11	15	20	29
	300	0.40	††	13	17	24	32
30	350	0.43	††	15	19	28	37
	150	0.34	††	–	9	14	22
	200	0.38	††	8**	12	16	24
36	250	0.42	††	11	15	19	27
	300	0.45	††	12	16	21	29
	350	0.49	††	15	19	25	33
	150	0.38	††	–	9	14	21
	200	0.42	††	8**	12	15	23
36	250	0.47	††	10	14	18	25
	300	0.51	††	12	16	20	28
	350	0.56	††	15	19	24	32

*To convert inches to millimeters, multiply by 25.4; to convert feet to meters, multiply by 0.3048; to convert pounds per square inch to kilopascals, multiply by 6.895.

†Ductile-iron pipe is adequate for the rated working pressure indicated for each nominal size plus a surge allowance of 100 psi (689 kPa). Calculations are based on a 2.0 safety factor times the sum of working pressure and 100 psi (689 kPa) surge allowance. (See ANSI/AWWA C150/A21.50 for design formulae.) Ductile-iron pipe for working pressures higher than 350 psi (2413 kPa) is available.

++An allowance for a single H-20 truck with 1.5 impact factor is included for all depths of cover.

§Calculated maximum depth of cover exceeds 100 ft. (30.5 m).

**Minimum allowable depth of cover is 3 ft. (0.9 m).

††For pipe 14 in. (350 mm) and larger, consideration should be given to the use of laying conditions other than Type 1.

SPECIAL THICKNESS CLASS
SELECTION TABLE FOR DUCTILE IRON PIPE RELATED TO WORKING PRESSURE, LAYING CONDITIONS AND DEPTH OF COVER

To find the thickness class required to meet a specific condition:

1. Select one of the five standard laying conditions shown on page 14.
2. From the tables below for your pipe size and laying condition selected in step 1, find the lowest thickness class that has a maximum depth of cover equal to or greater than required for your application.
3. Similarly find the lowest thickness class that has a rated working pressure equal to or greater than required for your application.
4. The larger of the two thickness classes determined in steps 3 and 4 is the thickness class that should be used for specifying and ordering ductile iron pipe for your application.

PIPE SIZE	ANSI THICK. CLASS	NOMINAL THICK. IN INCHES	RATED WATER WORKING PRESSURE PSI†	MAXIMUM DEPTH OF COVER IN FEET††				
				LAYING CONDITION TYPE 1	LAYING CONDITION TYPE 2	LAYING CONDITION TYPE 3	LAYING CONDITION TYPE 4	LAYING CONDITION TYPE 5
3	51	.25	350	98	100*	100*	100*	100*
	52	.28	350	100*	100*	100*	100*	100*
	53	.31	350	100*	100*	100*	100*	100*
	54	.34	350	100*	100*	100*	100*	100*
	55	.37	350	100*	100*	100*	100*	100*
4	56	.40	350	100*	100*	100*	100*	100*
	51	.26	350	76	86	96	100*	100*
	52	.29	350	100*	100*	100*	100*	100*
	53	.32	350	100*	100*	100*	100*	100*
	54	.35	350	100*	100*	100*	100*	100*
6	55	.38	350	100*	100*	100*	100*	100*
	56	.41	350	100*	100*	100*	100*	100*
	50	.25	350	32	38	44	56	75
	51	.28	350	49	57	64	80	100*
	52	.31	350	67	77	86	100*	100*
8	53	.34	350	91	100*	100*	100*	100*
	54	.37	350	100*	100*	100*	100*	100*
	55	.40	350	100*	100*	100*	100*	100*
	56	.43	350	100*	100*	100*	100*	100*
	50	.27	350	25	30	36	46	64
10	51	.30	350	36	42	49	61	81
	52	.33	350	47	54	62	77	99
	53	.36	350	64	73	82	100*	100*
	54	.39	350	80	91	100*	100*	100*
	55	.42	350	98	100*	100*	100*	100*
12	56	.45	350	100*	100*	100*	100*	100*
	50	.29	350	19	24	29	38	55
	51	.32	350	27	32	38	49	66
	52	.35	350	35	41	47	59	79
	53	.38	350	45	52	59	74	95
12	54	.41	350	57	65	74	91	100*
	55	.44	350	67	77	86	100*	100*
	56	.47	350	81	92	100*	100*	100*
	50	.31	350	17	22	27	36	52
	51	.34	350	23	28	33	43	60
12	52	.37	350	30	35	41	53	71
	53	.40	350	36	42	49	61	81
	54	.43	350	45	52	59	74	95
	55	.46	350	54	62	71	87	100*
	56	.49	350	64	73	83	100*	100*

continued on next page

CONTINUED

PIPE SIZE	ANSI THICK. CLASS	NOMINAL THICK. IN INCHES	RATED WATER WORKING PRESSURE PSI†	MAXIMUM DEPTH OF COVER IN FEET††				
				LAYING CONDITION TYPE 1	LAYING CONDITION TYPE 2	LAYING CONDITION TYPE 3	LAYING CONDITION TYPE 4	LAYING CONDITION TYPE 5
14	50	.33	350	15	19	24	33	49
	51	.36	350	19	23	28	38	55
	52	.39	350	24	29	34	44	62
	53	.42	350	30	35	41	53	71
	54	.45	350	36	42	49	61	81
	55	.48	350	43	50	57	71	92
	56	.51	350	52	59	67	83	100*
16	50	.34	350	13	17	21	30	47
	51	.37	350	16	21	25	34	51
	52	.40	350	20	25	30	40	57
	53	.43	350	25	30	36	46	64
	54	.46	350	30	35	41	53	71
	55	.49	350	35	41	47	59	79
	56	.52	350	41	48	55	68	89
18	50	.35	350	11	15	20	29	42
	51	.38	350	14	19	23	32	49
	52	.41	350	18	22	27	36	53
	53	.44	350	22	26	31	41	58
	54	.47	350	25	30	36	46	64
	55	.50	350	30	35	41	53	71
	56	.53	350	35	41	47	59	79
20	50	.36	300	10	14	18	27	38
	51	.39	350	13	18	21	30	44
	52	.42	350	16	20	25	34	50
	53	.45	350	19	23	28	38	54
	54	.48	350	22	27	32	42	59
	55	.51	350	26	31	37	47	65
	56	.54	350	30	35	41	53	71
24	50	.38	250	8	12	17	23	31
	51	.41	300	10	15	19	27	36
	52	.44	350	13	17	21	30	41
	53	.47	350	15	19	24	33	47
	54	.50	350	18	22	27	36	53
	55	.53	350	20	25	30	40	57
	56	.56	350	24	29	34	44	61
30	50	.39	200	**	10	14	18	25
	51	.43	250	**	12	16	21	29
	52	.47	300	**	14	19	24	33
	53	.51	350	**	17	21	29	38
	54	.55	350	**	19	24	33	44
	55	.59	350	**	22	27	36	51
	56	.63	350	**	26	31	41	57
36	50	.43	200	**	10	13	17	25
	51	.48	250	**	12	16	20	28
	52	.53	300	**	15	19	24	32
	53	.58	350	**	17	21	28	37
	54	.63	350	**	20	25	33	43
	55	.68	350	**	23	28	37	50
	56	.73	350	**	26	31	41	59

†These pipe are adequate for the rated working pressure plus a surge allowance of 100 psi Ductile Iron pipe for working pressures higher than 350 psi is available.

††An allowance for a single AASHO H-20 truck (16,000 pound wheel load) with 1.5 impact factor included for all depths of cover.

*Calculated depth of cover exceeds 100 feet.

**Consideration should be given to the use of laying conditions other than Type 1.

**DUCTILE IRON PIPE THICKNESS REQUIRED
FOR DIFFERENT TAP SIZES**

Pipe Thickness in inches, required for different tap sizes with 2, 3, or 4 full threads (ANSI/AWWA C151/A21.51 Appendix)

NOMINAL PIPE SIZE INCHES	NUMBER OF FULL THREADS	TAP SIZE WITH ANSI/ASME B1.20.1 STANDARD TAPER PIPE THREADS										TAP SIZE AWWA C800 STANDARD CORPORATION STOP THREADS							
		1/2	3/4	1	1-1/4	1-1/2	2	2-1/2	3	3-1/2	4	1/2	5/8	3/4	1	1-1/4	1-1/2	2	
3	2	.18	.21	.28								.21	.24	.25	.33				
3	3	.26	.29	.37								.29	.32	.33	.41				
3	4	.33	.36	.46								.36	.39	.40	.49				
4	2	.17	.19	.26	.31							.19	.22	.23	.30	.36			
4	3	.25	.27	.35	.40							.27	.30	.31	.38	.45			
4	4	.32	.34	.44	.49							.34	.37	.38	.46	.54			
6	2	.17	.18	.23	.27	.30						.18	.20	.20	.26	.30	.35		
6	3	.25	.26	.32	.36	.39						.26	.28	.28	.34	.39	.44		
6	4	.32	.33	.41	.45	.48						.33	.35	.35	.42	.48	.53		
8	2	.16	.17	.22	.24	.27	.33					.17	.18	.19	.24	.27	.31	.39	
8	3	.24	.25	.31	.33	.36	.42					.25	.26	.27	.32	.36	.40	.48	
8	4	.31	.32	.40	.42	.45	.51					.32	.33	.34	.40	.45	.49	.57	
10	2	.15	.17	.21	.23	.25	.30	.44				.17	.17	.18	.23	.25	.28	.35	
10	3	.23	.25	.30	.32	.34	.39	.56				.25	.25	.26	.31	.34	.37	.44	
10	4	.30	.32	.39	.41	.43	.48	.69				.32	.32	.33	.39	.43	.46	.53	
12	2	.15	.16	.20	.22	.24	.28	.40	.48			.16	.17	.17	.22	.24	.26	.32	
12	3	.23	.24	.29	.31	.33	.37	.52	.60			.23	.25	.25	.30	.33	.35	.41	
12	4	.30	.31	.38	.40	.42	.46	.65	.73			.31	.32	.32	.38	.42	.44	.50	
14	2	.15	.16	.20	.22	.23	.26	.38	.45	.51	.58	.16	.17	.17	.21	.23	.25	.30	
14	3	.23	.24	.29	.31	.32	.35	.50	.58	.64	.70	.24	.25	.25	.29	.32	.34	.39	
14	4	.30	.31	.38	.40	.41	.44	.63	.70	.76	.83	.31	.32	.32	.37	.41	.43	.48	
16	2	.15	.16	.20	.21	.22	.25	.37	.43	.48	.54	.16	.16	.17	.21	.22	.24	.28	
16	3	.23	.24	.29	.30	.31	.34	.50	.56	.60	.66	.24	.24	.25	.29	.31	.33	.37	
16	4	.30	.31	.38	.39	.40	.43	.62	.68	.73	.79	.31	.31	.32	.37	.40	.42	.46	
18	2	.15	.15	.19	.21	.22	.24	.35	.41	.46	.51	.15	.16	.16	.20	.21	.23	.27	
18	3	.23	.23	.28	.30	.31	.33	.48	.54	.58	.64	.23	.24	.24	.28	.30	.32	.36	
18	4	.30	.30	.37	.39	.40	.42	.60	.66	.71	.76	.30	.31	.31	.36	.39	.41	.45	
20	2	.15	.15	.19	.20	.21	.23	.34	.39	.44	.49	.15	.16	.16	.20	.21	.23	.26	
20	3	.23	.23	.28	.29	.30	.32	.46	.52	.56	.62	.23	.24	.24	.28	.30	.32	.35	
20	4	.30	.30	.37	.38	.39	.41	.59	.64	.69	.74	.30	.31	.31	.36	.39	.41	.44	
24	2	.14	.15	.19	.20	.21	.22	.32	.37	.40	.45	.15	.15	.16	.19	.21	.22	.24	
24	3	.22	.23	.28	.29	.30	.31	.44	.50	.52	.58	.23	.23	.24	.27	.30	.31	.33	
24	4	.29	.30	.37	.38	.39	.40	.57	.62	.65	.70	.30	.30	.31	.35	.39	.40	.42	
30	2	.14	.15	.19	.19	.20	.21	.31	.34	.37	.41	.15	.15	.16	.19	.20	.21	.23	
30	3	.22	.23	.28	.28	.29	.30	.44	.46	.50	.54	.23	.23	.24	.27	.29	.30	.32	
30	4	.29	.30	.37	.37	.38	.39	.56	.59	.62	.66	.30	.30	.31	.35	.38	.39	.41	
36	2	.14	.14	.18	.19	.20	.21	.30	.33	.35	.38	.14	.15	.15	.19	.20	.20	.22	
36	3	.22	.22	.27	.28	.29	.30	.42	.46	.48	.50	.22	.23	.23	.27	.29	.29	.31	
36	4	.29	.29	.36	.37	.38	.39	.55	.58	.60	.63	.29	.30	.30	.35	.38	.38	.40	

**TEMPLATE FOR DRILLING EXTRA HEAVY 250 POUND FLANGES
AMERICAN NATIONAL STANDARD SPECIFICATION B16.1 FOR 250
POUND TEMPLATE †**

SIZE INCHES	DIAMETER OF FLANGE INCHES	THICKNESS OF FLANGE (MIN.) INCHES	DIAMETER OF RAISED FACE INCHES	DIAMETER OF BOLT CIRCLE INCHES	NUMBER OF BOLTS	DIAMETER OF BOLTS INCHES	LENGTH OF BOLTS INCHES
3	8-1/4	1-1/8	5-11/16	6-5/8	8	3/4	3-1/2
4	10	1-1/4	6-15/16	7-7/8	8	3/4	3-3/4
6	12-1/2	1-7/16	9-11/16	10-5/8	12	3/4	4
8	15	1-5/8	11-15/16	13	12	7/8	4-1/2
10	17-1/2	1-7/8	14-1/16	15-1/4	16	1	5-1/4
12	20-1/2	2	16-7/16	17-3/4	16	1-1/8	5-1/2
14	23	2-1/8	18-15/16	20-1/4	20	1-1/8	6
16	25-1/2	2-1/4	21-1/16	22-1/2	20	1-1/4	6-1/4
18	28	2-3/8	23-5/16	24-3/4	24	1-1/4	6-1/2
20	30-1/2	2-1/2	25-9/16	27	24	1-1/4	6-3/4
24	36	2-3/4	30-5/16	32	24	1-1/2	7-3/4
30	43	3	37-3/16	39-1/4	28	1-3/4	8-1/2

†ANSI B16.1 250 pound cast iron flanges have 1/16-inch raised face.

Note: Drilling templates are in multiples of four, so that fittings may be made to face in any quarter. Bolt holes shall straddle the center line.

**FOR INFORMATION ONLY
GRAY CAST IRON PIPE
CENTRIFUGALLY CAST IN METAL MOLDS**

American National Standards Institute Standard ANSI/AWWA C101/A21.1 A21.6 (AWWA C106)

CLASS THICKNESS – NOW OBSOLETE

NOMINAL DIAMETER INCHES	STANDARD CLASS NUMBERS FOR THICKNESS OF PIPE									
	20	21	22	23	24	25	26	27	28	29
	PIPE THICKNESS IN INCHES									
332	.35	.38	.41	.44	.48	.52	.56
4	..	.32	.35	.38	.41	.44	.48	.52	.56	.60
6	..	.35	.38	.41	.44	.48	.52	.56	.60	.65
8	.35	.38	.41	.44	.48	.52	.56	.60	.65	.70
10	.38	.41	.44	.48	.52	.56	.60	.65	.70	.76
12	.41	.44	.48	.52	.56	.60	.65	.70	.76	.82
14	.43	.48	.51	.55	.59	.64	.69	.75	.81	.87
16	.46	.50	.54	.58	.63	.68	.73	.79	.85	.92
18	.50	.54	.58	.63	.68	.73	.79	.85	.92	.99
20	.53	.57	.62	.67	.72	.78	.84	.91	.98	1.06
24	.58	.63	.68	.73	.79	.85	.92	.99	1.07	1.16

FOR INFORMATION
DIMENSIONS OF GASKETS, BOLTS AND STUDS
FOR CLASS 125 CAST IRON FLANGED JOINTS
GASKETS OF SHEET PACKING



Ring Gasket

Red sheet rubber
Cloth inserted rubber



Full Face Gasket†

Gaskets of sheet packing are regularly furnished 1/8-inch thick.

RING GASKETS

NOMINAL SIZE— INCHES	2	3	4	5	6	8	10
GASKET I.D.— INCHES	2	3	4	5	6	8	10
GASKET O.D.— INCHES	4-1/8	5-3/8	6-7/8	7-3/4	8-3/4	11	13-3/8
NOMINAL SIZE— INCHES	12	14	16	18	20	24	30
GASKET I.D.— INCHES	12	14	16	18	20	24	30
GASKET O.D.— INCHES	16-1/8	17-3/4	20-1/4	21-5/8	23-7/8	28-1/4	34-3/4

FULL FACE GASKETS†

NOMINAL SIZE— INCHES	2	3	4	5	6	8	10	12
GASKET I.D.— INCHES	2	3	4	5	6	8	10	12
GASKET O.D.— INCHES	6	7-1/2	9	10	11	13-1/2	16	19

†Holes are punched in full face gaskets unless specifically ordered otherwise.
Full face gaskets are not recommended for 14" and larger sizes.



(A) Machine Bolt ††

Hex Head — Hexagon Nut



(B) Bolt-Stud††

With Two Hexagon Nuts



(C) Stud*

With One Hexagon Nut

MACHINE BOLTS, BOLT-STUDS, AND STUDS

SIZES, LENGTHS AND WEIGHTS

FOR FLANGED FITTINGS SIZE-INCHES	NUMBER OF BOLTS TO THE JOINT	DIAMETER OF BOLTS INCHES	BOLTS, BOLT-STUDS AND STUDS					
			LENGTH INCHES			WEIGHT—PER 100-POUNDS		
			(A)	(B)	(C)	(A)	(B)	(C)
2	4	5/8	2-1/4	40
3	4	5/8	2-1/2	3-1/4	2-1/4	41	47	29
4	8	5/8	3	3-3/4	2-1/2	45	51	30
5	8	3/4	3	69
6	8	3/4	3-1/4	4	3	71	81	51
8	8	3/4	3-1/2	4	3	75	81	51
10	12	7/8	3-3/4	4-3/4	3-1/2	113	127	76
12	12	7/8	3-3/4	4-3/4	3-1/4	113	127	76
14	12	1	4-1/4	5-1/4	3-3/4	163	285	113
18	16	1-1/8	4-3/4	6	4-1/4	230	251	161
20	16	1-1/8	5	6	4-1/4	236	251	161
24	20	1-1/4	5-1/2	6-1/2	4-1/2	325	251	213
30	28	1-1/4	6-1/4	7-1/2	5	355	377	225

††Length of Bolts and Bolt-Studs is based on two 125 flanges bolted together. If "Filler" is used between flanges, bolt-stud length must be increased by thickness of filler.

* The length of Studs is based on the short threaded end being screwed into a tapped hole for a distance approximately equal to the diameter of the stud.

Above bolts meet requirement of the ANSI B16.1 Standard.

SAND CAST – BELL AND SPIGOT CAST IRON PIPE – FOR WATER

Meeting American Water Works Association Specifications of May 12, 1908

NOW OBSOLETE – FOR INFORMATION ONLY



Classes A, B, C, D

Most cast iron pipe installed in water distribution systems in our country prior to 1927 was made to the specifications below. Considering that most of these installations are still in service, we include this data in our catalog for information only. We do not now manufacture this pipe.

OUTSIDE DIAMETER – INCHES

NOMINAL PIPE SIZE INCHES	4	6	8	10	12	14	16	18	20	24
CLASS "A"	4.80	6.90	9.05	11.10	13.20	15.30	17.40	19.50	21.60	25.80
CLASS "B"	5.00	7.10	9.05	11.10	13.20	15.30	17.40	19.50	21.60	25.80
CLASS "C"	5.00	7.10	9.30	11.40	13.50	15.65	17.80	19.92	22.06	26.32
CLASS "D"	5.00	7.10	9.30	11.40	13.50	15.65	17.80	19.92	22.06	26.32

THICKNESSES AND WEIGHTS*

NOMINAL INSIDE DIAMETER INCHES	CLASS "A" 100- FOOT HEAD 43 POUNDS PRESSURE				CLASS "B" 200-FOOT HEAD 86 POUNDS PRESSURE					
	THICKNESS INCHES	WEIGHT OF 12-FOOT LENGTH POUNDS PER		WEIGHT OF 16-FOOT LENGTH POUNDS PER		THICKNESS INCHES	WEIGHT OF 12-FOOT LENGTH POUNDS PER		WEIGHT OF 16-FOOT LENGTH POUNDS PER	
		FOOT	LENGTH	FOOT	LENGTH		FOOT	LENGTH	FOOT	LENGTH
4	.42	20.0	240	19.7	315	.45	21.7	260	21.2	340
6	.44	30.8	370	30.3	485	.48	33.3	400	32.5	520
8	.46	42.9	515	42.2	675	.51	47.5	570	46.6	745
10	.50	57.1	685	55.9	895	.57	63.8	765	62.5	1000
12	.54	72.5	870	71.2	1140	.62	82.1	985	80.6	1290
14	.57	89.6	107566	102.5	1230
16	.60	108.3	130070	125.0	1500
18	.64	129.2	155075	150.0	1800
20	.67	150.0	180080	175.0	2100
24	.76	204.2	245089	233.3	2800

NOMINAL INSIDE DIAMETER INCHES	CLASS "C" 300- FOOT HEAD 130 POUNDS PRESSURE				CLASS "D" 400-FOOT HEAD 173 POUNDS PRESSURE					
	THICKNESS INCHES	WEIGHT OF 12-FOOT LENGTH POUNDS PER		WEIGHT OF 16-FOOT LENGTH POUNDS PER		THICKNESS INCHES	WEIGHT OF 12-FOOT LENGTH POUNDS PER		WEIGHT OF 16-FOOT LENGTH POUNDS PER	
		FOOT	LENGTH	FOOT	LENGTH		FOOT	LENGTH	FOOT	LENGTH
4	.48	23.3	280	22.8	365	.52	25.0	300	24.4	390
6	.51	35.8	430	35.0	560	.55	38.3	450	37.5	600
8	.56	52.1	625	50.9	815	.60	55.8	670	54.7	875
10	.62	70.8	850	69.4	1110	.68	76.7	920	75.3	1205
12	.68	91.7	1100	90.0	1440	.75	100.0	1200	98.4	1575
14	.74	116.7	140082	129.2	1550
16	.80	143.8	172589	158.3	1900
18	.87	175.0	210096	191.7	2300
20	.92	208.3	2500	1.03	229.2	2750
24	1.04	279.2	3350	1.16	306.7	3680

*All weights are approximate. The difference in weight per foot between the 12 and 16 foot lengths is accounted for by the fact that the weight of the bell in the longer length is spread over a great number of feet. The weight of pipe without bell is the same in both lengths.

FLOW OF WATER IN DUCTILE IRON PIPE

Virtually all ductile iron pipe produced for water transmission and distribution today are cement-mortar/lined in accordance with ANSI/AWWA C104/A21.4.

The flow of water through this pipe is usually computed by the widely used Williams-Hazen formula:

$$Q = 0.006756 \times CD^{2.63} H^{.54}$$

Where:

Q = discharge in gallons per minute

C = Williams-Hazen flow coefficient

D = actual inside diameter

H = head loss in feet per 1,000 feet

The flow coefficient "C" (or C factor) in the Williams-Hazen formula is in effect a measure of the condition of the pipe interior and is sometimes known as a friction coefficient. Tests employing this formula show that cement-mortar/lined ductile iron pipe has a C factor of about 140. Unlined pipe exposed to aggressive waters will suffer loss in C factor due to tuberculation.

Ductile iron pipe has flow advantages resulting from its greater than nominal internal diameters. For example, Class 52, 12-inch unlined ductile iron pipe has an inside diameter of 12.46 inches. Standard cement-lined pipe of this same class has an inside diameter of 12.34 inches.

The nomograph on page 233 may be used to determine discharge or loss of head for any assumed C factor.

EXAMPLES FOR USE OF NOMOGRAPH

Example 1 – Maximum Delivery

To find the maximum delivery of an 8-inch, Class 52, cement-mortar-lined ductile iron pipe, 7,500 feet in length under 150 feet of head. The loss of head per 1,000 feet is $150 / 7.5 = 200$ feet per 1,000 feet. By use of the nomograph on page 233, the result is 1,200 gallons per minute or 1.73 million gallons per day. (20.00 ft. loss per 1,000 ft. and 8-inch. diameter pipe)

Example 2 – Determination of Diameter

To find the diameter of pipe necessary to deliver 3,000,000 gallons per day through a

pipeline 25,000 feet long under 150 feet of head. The loss of head per 1,000 feet is $150/7.5 = 6$ feet per 1,000 feet. By use of the nomograph on page 233, the result is 12-inch, Class 52, cement-mortar-lined ductile iron pipe (6.00 ft. loss per 1,000 ft. and $3,000,000 \div 1440$ minutes per day = 2,083 gals. per min.)

Example 3 – Friction Loss

To find the loss of head through a 10-inch, Class 52, cement-mortar-lined ductile iron pipeline 4,000 feet long, delivering 1,400,000 gallons per day, using a C factor of 140. By use of the nomograph on page 233, the head loss is 4 feet per 1,000 feet, or 16 feet for the pipeline. (10 inch diameter pipe and $1,400,000 \div 1440$ minutes per day = 972 gallons per min.) If water is delivered at a point 100 feet above the pump, total head against the pump is 100 feet (static) plus 16 feet (friction), or a total of 116 feet.

Example 4 – Delivery Determined from Pressure Reduction

Two accurate pressure gauges should be placed at a known distance apart and measurement of the difference in elevation recorded. If on a 12-inch pipeline the pressure gauges are 500 feet apart and show a difference in pressure of 2 psi (4.6 feet of head) while one gauge is 1.8 feet above the other, the actual loss of head will be 4.6 plus or minus 1.8 = 6.4 or 2.8 feet per 500 feet or 12.8 or 5.6 feet per 1,000 feet, depending on whether the downstream gauge is higher or lower than gauge nearest the pump. Assuming that the downstream gauge is at the higher elevation, head loss due to friction is 5.6 feet per 1,000 feet. By use of the nomograph on page 233, the result is 1,900 gallons per minute, or 2.74 million gallons per day. (12-inch diameter pipe and 5.60 ft. loss per 1,000 ft.)

**FLOW OF WATER IN DUCTILE IRON PIPE
NOMOGRAPH FOR CALCULATING FLOW**

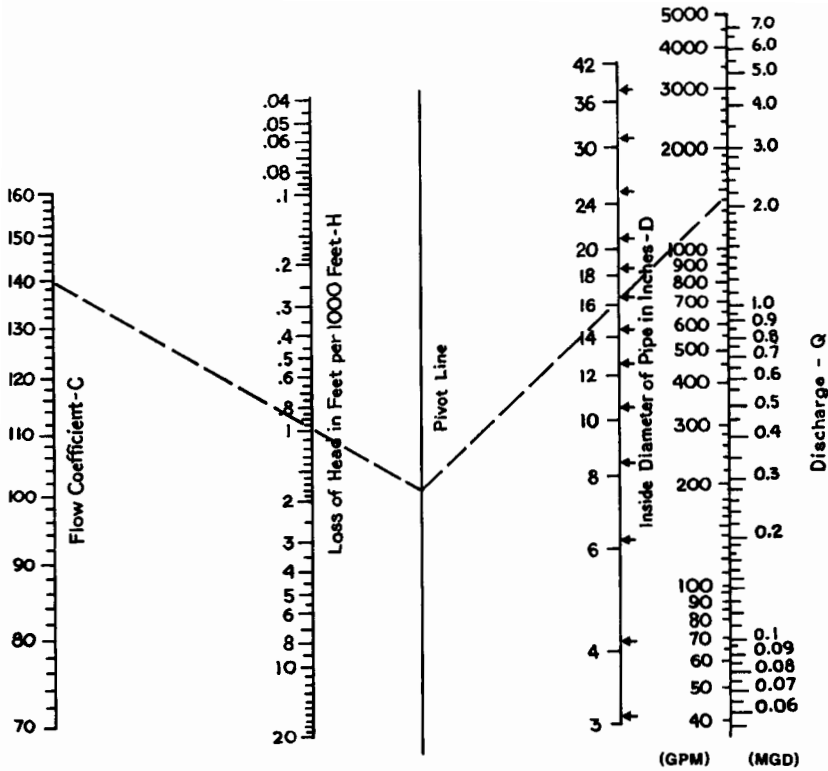

The above nomograph is based on the Williams-Hazen flow formula and shows relationships between flow coefficient, head loss, internal pipe diameter and discharge rate. If any three of these factors are known, the fourth may be determined by locating a point on the pivot line, which point lies on a common line with two of the known factors. Once the pivot is established, the unknown factor will lie on a straight line between the pivot point and the third known factor. Arrows (←) on the inside diameter line represent actual inside diameter of cement-mortar-lined ductile iron pipe: Class 52, in the 3-inch through 12-inch sizes, and Class 51 in the 14-inch and larger sizes. The dashed line represents the use of this nomograph for 16-inch ductile iron pipe with an assumed flow co-efficient of C-140.

EQUATION OF PIPE
(Based on Nominal Pipe Inside Diameters)

It is frequently desired to know what number of pipe of a given size are equal in carrying capacity to one pipe of a larger size. At the same velocity of flow the volume delivered by two pipe of different sizes is proportional to the squares of their diameters; thus one 4-inch pipe will deliver the same volume as four 2-inch pipe. With the same head, however, the velocity is less in the smaller pipe, and the volume delivered varies about as their diameter ratio to the 2.65 power. This table is calculated on this basis. The figures opposite the intersection of any two sizes is the number of the smaller-sized pipe required to equal one of the larger; thus one 6-inch equals 2.9-four inch.

EQUATION OF PIPE

DIA. INCHES	1/2	3/4	1	2	3	4	5	6	7	8	10	12	14	16	18	20	24	30	36	42	48	
2	39.4	13.5	6.3	1.0
3	115.	39.4	18.4	2.9	1.0
4	247.	84.4	39.4	6.3	2.1	1.0
5	447.	153.	71.2	11.3	3.9	1.8	1.0
6	724.	247.	115.	18.4	6.3	2.9	1.6	1.0
7	1,090.	372.	174.	27.7	9.4	4.4	2.4	1.5	1.0
8	530.	247.	39.4	13.5	6.3	3.5	2.1	1.4	1.0
10	957.	447.	71.2	24.3	11.3	6.3	3.9	2.6	1.8	1.0
11	575.	91.6	31.3	14.6	8.1	5.0	3.3	2.3	1.3
12	724.	115.	39.4	18.4	10.2	6.3	4.2	2.9	1.6	1.0
13	895.	143.	48.7	22.7	12.6	7.8	5.2	3.6	2.0	1.2
14	1,090.	174.	59.3	27.7	15.3	9.4	6.3	4.4	2.4	1.5	1.0
15	1,308.	208.	71.2	33.2	18.4	11.3	7.5	5.3	2.9	1.8	1.2
16	247.	84.4	39.4	21.8	13.5	8.9	6.3	3.5	2.1	1.4	1.0
17	290.	99.2	46.3	25.6	15.8	10.5	7.4	4.1	2.5	1.7	1.2
18	338.	115.	53.8	29.8	18.4	12.2	8.6	4.7	2.9	1.9	1.4	1.0
19	390.	133.	62.1	34.4	21.2	14.1	9.9	5.5	3.4	2.2	1.6	1.2
20	447.	153.	71.2	39.4	24.3	16.2	11.3	6.3	3.9	2.6	1.8	1.3	1.0
22	575.	196.	91.6	50.7	31.3	20.8	14.6	8.1	5.0	3.3	2.3	1.7	1.3
24	724.	247.	115.	63.8	39.4	26.2	18.4	10.2	6.3	4.2	2.9	2.1	1.6	1.0
30	33.2	18.4	11.3	7.5	5.3	3.9	2.9	1.8	1.0
36	29.8	18.4	12.2	8.6	6.3	4.7	2.9	1.6	1.0
42	44.8	27.7	18.4	12.9	9.4	7.1	4.4	2.4	1.6	1.0
48	63.8	39.4	26.2	18.4	13.5	10.2	6.3	3.5	2.1	1.4	1.0

CONTENTS OF PIPE

Capacities in Cubic Feet and in United States Gallons (231 Cubic Inches)

DIAMETER INCHES	DIAMETER FEET	FOR 1 FOOT LENGTH		DIAMETER INCHES	DIAMETER FEET	FOR 1 FOOT LENGTH	
		CUBIC FEET, ALSO AREA IN SQ. FEET	U.S. GALS. (231 CU. IN.)			CUBIC FEET, ALSO AREA IN SQ. FEET	U.S. GALS. (231 CU. IN.)
1/4	.0208	.0003	.0026	11.25	.9375	.6903	5.163
5/8	.0260	.0005	.0040	11.50	.9583	.7213	5.395
3/8	.0313	.0008	.0057	11.75	.9792	.7530	5.633
7/16	.0365	.0010	.0078	12.00	1.000	.7854	5.876
1/2	.0417	.0014	.0102	12.50	1.042	.8533	6.375
9/16	.0469	.0017	.0129	13.00	1.083	.9218	6.895
5/8	.0521	.0021	.0159	13.50	1.125	.9940	7.435
11/16	.0573	.0026	.0193	14.00	1.167	1.069	7.997
3/4	.0625	.0031	.0230	14.50	1.208	1.147	8.578
13/16	.0677	.0036	.0270	15.00	1.25	1.227	9.180
7/8	.0729	.0042	.0312	15.50	1.292	1.310	9.801
15/16	.0781	.0048	.0359	16.00	1.333	1.296	10.44
1.00	.0833	.0055	.0408	16.50	1.375	1.485	11.11
1.25	.1042	.0085	.0638	17.00	1.417	1.576	11.79
1.50	.1250	.0123	.0918	17.50	1.458	1.570	12.50
1.75	.1458	.0168	.1250	18.00	1.500	1.767	13.22
2.00	.1667	.0218	.1632	18.50	1.542	1.867	13.97
2.25	.1875	.0276	.2066	19.00	1.583	1.969	14.73
2.50	.2083	.0341	.2550	19.50	1.625	2.074	15.52
2.75	.2292	.0413	.3085	20.00	1.666	2.182	16.32
3.00	.2500	.0491	.3673	20.50	1.708	2.292	17.15
3.25	.2708	.0576	.4310	21.00	1.760	2.405	17.99
3.50	.2917	.0668	.4998	21.50	1.792	2.521	18.86
3.75	.3125	.0767	.5738	22.00	1.833	2.640	19.76
4.00	.333	.0873	.6528	22.50	1.875	2.761	20.65
4.25	.3542	.0985	.7370	23.00	1.917	2.885	21.58
4.50	.3750	.1105	.8263	23.50	1.958	3.012	22.53
4.75	.3958	.1231	.9205	24.00	2.000	3.142	23.50
5.00	.4167	.1364	1.020	25.00	2.083	3.409	25.50
5.25	.4375	.1503	1.124	26.00	2.166	3.687	27.58
5.50	.4583	.1650	1.234	27.00	2.250	3.976	29.74
5.75	.4792	.1803	1.349	28.00	2.333	4.276	31.99
6.00	.5000	.1963	1.469	29.00	2.416	4.587	34.31
6.25	.5208	.2130	1.594	30.00	2.500	4.909	36.72
6.50	.5417	.2305	1.724	31.00	2.583	5.241	39.21
6.75	.5625	.2485	1.859	32.00	2.666	5.585	41.78
7.00	.5833	.2673	1.999	33.00	2.750	5.940	44.43
7.25	.6042	.2868	2.144	34.00	2.833	6.305	47.17
7.50	.6250	.3068	2.295	35.00	2.916	6.681	49.98
7.75	.6458	.3275	2.450	36.00	3.000	7.069	52.88
8.00	.6667	.3490	2.611	37.00	3.083	7.468	55.86
8.25	.6875	.3713	2.777	38.00	3.166	7.876	58.92
8.50	.7083	.3940	2.948	39.00	3.250	8.296	62.06
8.75	.7292	.4175	3.125	40.00	3.333	8.728	65.29
9.00	.7500	.4418	3.305	41.00	3.416	9.168	68.58
9.25	.7708	.4668	3.492	42.00	3.500	9.620	71.96
9.50	.7917	.4923	3.682	43.00	3.583	10.084	75.43
9.75	.8125	.5185	3.879	44.00	3.666	10.560	79.00
10.00	.8333	.5455	4.081	45.00	3.750	11.044	82.62
10.25	.8542	.5730	4.286	46.00	3.833	11.540	86.32
10.50	.8750	.6013	4.498	47.00	3.916	12.048	90.12
10.75	.8958	.6303	4.714	48.00	4.000	12.566	94.02
11.00	.9167	.6600	4.937

CONVERSION FACTORS

Unless designated otherwise, the English measures of capacity are those used in the United States, and the units of weight and mass are avoirdupois units.

The word gallon, used in any conversion factor, designates the U.S. gallon. To convert into the Imperial gallon, multiply the U.S. gallon by 0.83267. Likewise, the word ton designates a short ton, 2,000 pounds.

The figures 10^{-1} , 10^{-2} , 10^{-3} , etc. denote 0.1, 0.01, 0.001, etc. respectively.

The figures 10^1 , 10^2 , 10^3 , etc. denote 10, 100, 1000, etc. respectively.

In the conversion factors given below using the properties of water, calculations are based on water at 39.2°F. in vacuum, weighing 62.427 pounds per cubic foot, or 8.345 pounds per U.S. gallon. Water freezes at 32°F., and is at its maximum density at 39.2°F.

“Parts Per Million”, designated as P.P.M., is always by weight. As used in the Sanitary field, P.P.M. represents the number of pounds of dry solids contained in one million pounds of water, including solids. In this field, one part per million may be expressed as 8.345 pounds of dry solids to one million U.S. gallons of water.

Multiply	By	To Obtain
Acres	43,560	Square Feet
"	4047	Square meters
Acre-feet	43,560	Cubic feet
"	325,851	Gallons
"	1233.49	Cubic meters
Atmospheres	76.0	Cms. of mercury
"	29.92	Inches of mercury
"	33.90	Feet of water
"	14.70	Lbs./sq. inch
Barrels-cement	376	Pounds-cement
Bags or sacks-cement	94	Pounds-cement
Bars	14,504	Pounds/sq. inch
Bars	100	Kilopascals (kPa)
British thermal units	0.2520	Kilogram-calories
"	777.5	Foot-lbs.
"	3.927×10^{-4}	Horse-power-hrs.
"	107.5	Kilogram-meters
"	2.928×10^{-4}	Kilowatt-hrs.
B.t.u./min.	12.96	Foot-lbs./sec.
"	0.02356	Horse-power
"	0.01757	Kilowatts
Centimeters	0.3937	Inches
"	0.01	Meters
"	10	Millimeters
Centimeters. of mercury	0.01316	Atmospheres
"	0.4461	Feet of water
"	27.85	Lbs./sq. ft
"	0.1934	Lbs./sq. inch
Centimeters /second	1.969	Feet/min.
"	0.03281	Feet/sec.
"	0.6	Meters/min.
"	0.02237	Miles/hr.
"	3.728×10^{-4}	Miles/min.
Cubic cm	3.531×10^{-5}	Cubic feet
"	6.102×10^{-2}	Cubic inches
"	10^{-6}	Cubic meters
"	2.642×10^{-4}	Gallons

Multiply	By	To Obtain
Cubic cm	10^{-3}	Liters
"	2.113×10^{-3}	Pints (liq.)
"	1.057×10^3	Quarts (liq.)
Cubic feet	2.832×10^4	Cubic cms.
"	1728	Cubic inches
"	0.02832	Cubic meters
"	0.03704	Cubic yards
"	7.48052	Gallons
"	28.32	Liters
"	59.84	Pints (liq.)
"	29.92	Quart (liq.)
Cubic feet/min	472.0	Cubic cms./sec.
"	0.1247	Gallons/sec.
"	0.4720	Liters/sec.
"	62.43	Pounds of water/min.
Cubic ft/second	0.646317	Million gals./day
"	448.831	Gallons/min.
Cubic inches	16.39	Cubic centimeters
"	5.787×10^{-4}	Cubic feet
"	1.639×10^{-5}	Cubic meters
"	2.143×10^{-5}	Cubic yards
"	4.329×10^{-3}	Gallons
"	1.639×10^{-2}	Liters
"	0.03463	Pints (liq.)
"	0.01732	Quarts (liq.)
Cubic meters	10^6	Cubic centimeters
"	35.31	Cubic feet
"	61.023	Cubic inches
"	1308	Cubic yards
"	264.2	Gallons
Cubic meters	10^3	Liters
"	2113	Pints (liq.)
"	1057	Quarts (liq.)
Cubic yards	7.646×10^5	Cubic cm
"	27	Cubic feet
"	46,656	Cubic inches
"	0.7646	Cubic meters
"	202.0	Gallons

CONTINUED

<u>Multiply</u>	<u>By</u>	<u>To Obtain</u>	<u>Multiply</u>	<u>By</u>	<u>To Obtain</u>
Cubic yards	764.6	Liters	Grains/U.S. gal	142.86	Lbs./million gal.
"	1616	Pints (liq.)	Grains/Imp. gal	14.254	Parts/millions
"	807.9	Quarts (liq.)	Grams	980.7	Dynes
Drams	27.34375	Grains	Grams	15.43	Grains
"	0.0625	Ounces	Grams	0.03527	Ounces
"	1.771845	Grams	Grams/liter	58.417	Grains/gal.
Fathoms	6	Feet	"	8.345	Pounds/1000 gal.
Feet	30.48	Centimeters	"	1000	Parts/million
"	0.3048	Meters	Hectares	2.471	Acres
Feet of water	0.02950	Atmospheres	Horse-power	42.44	B.t. units/min.
"	0.8826	Inches of mercury	"	33,000	Foot-lbs./min.
"	304.8	Kgs./sq. meter	"	550	Foot-lbs./sec.
"	62.43	Lbs./sq. ft.	"	0.7457	Kilowatts
"	0.4335	Lbs./sq. inch	"	745.7	Watts
Feet/min.	0.01667	Feet/sec.	Horse-power		
"	0.01829	Kilometers/hr.	(boiler)	33,479	B.t.u./hr.
"	0.3048	Meters/min.	Inches	2.540	Centimeters
"	0.01136	Miles/hr.	Inches		
Feet/sec.	30.48	Centimeters/sec.	of mercury	0.03342	Atmospheres
"	18.29	Meters/min.	"	1.133	Feet of water
"	0.6818	Miles/hr.	"	70.73	Lbs./sq. ft.
Foot-pounds	1.286x10 ⁻³	BTU	"	0.4912	Lbs./sq. inch
"	5.050x10 ⁻⁷	Horse-power-hrs.	Inches of water	0.002458	Atmospheres
"	3.241x10 ⁻⁴	Kg.-calories	"	0.07355	Inches of mercury
"	3.766x10 ⁻⁷	Kilowatt-hrs.	"	0.5781	Ounces./sq. inch
Foot-lbs/min.	1.286x10 ⁻³	BTU/min.	"	5.202	Lbs./sq. foot
"	0.01667	Foot-pounds/sec.	"	0.03613	Lbs./sq. inch
"	3.030x10 ⁻⁵	Horse-power	Kilograms	2.205	Lbs.
"	3.241x10 ⁻⁴	Kg.-calories/min.	Kg.-cals/min.	51.43	Foot-pounds/sec.
"	2.260x10 ⁻⁵	Kilowatts	"	0.09351	Horse-power
Foot-lbs/sec.	7.717x10 ⁻²	B.t. units/min.	"	0.06972	Kilowatts
"	1.818x10 ⁻³	Horse-power	Kgs./sq. meter	3.281x10 ⁻³	Feet of water
"	1.945x10 ⁻²	Kg.-calories/min.	Kgs./sq. meter	1.422x10 ⁻³	Lbs./sq. inch
"	1.356x10 ⁻³	Kilowatts	Kilometers	3281	Feet
Gallons	3785	Cubic centimeters	"	0.6214	Miles
"	0.1337	Cubic feet	"	1094	Yards
"	231	Cubic inches	Kilometers/hr.	27.78	Centimeters/sec.
"	3.785x10 ⁻³	Cubic meters	"	54.68	Feet/min.
"	3.785	Liters	"	0.9113	Feet/sec.
"	8	Pints (liq.)	"	0.6214	Miles/hr.
"	4	Quarts (liq.)	Kilopascals		
Gallons, Imp.	1.20095	U.S. Gallons	(kPa)	0.145	Pounds/sq. inch
Gallons, U.S.	0.83267	Imperial Gallons	Kilowatts	56.92	B.t. units/min.
Gallons water	8.3453	Pounds of water	"	4.425x10 ⁴	Foot-lbs./min.
Gallons/min.	2.228x10 ⁻³	Cubic feet/sec.	"	737.6	Foot-lbs./min.
"	0.06308	Liters/sec.	"	1.341	Horse-power
"	8.0208	Cu. ft./hr.	"	14.34	Kg.-calories/min.
Gals. water/min.	6.0086	Tons water/24 hrs.	Liters	0.03531	Cubic feet
Grains (troy)	1	Grains (avoird)	"	61.02	Cubic inches
"	0.06480	Grams	"	0.2642	Gallons
Grains/U.S. gal	17.118	Parts/million	Liters/min.	5.886x10 ⁻⁴	Cubic ft.-sec.
			"	4.403x10 ⁻³	Gals./sec.

CONTINUED

Multiply	By	To Obtain	Multiply	By	To Obtain
Megapascals (Mpa)	145	Pounds/sq. inch	Quarts (liq.)	57.75	Cubic inches
Meters	3.281	Feet	Quires	25	Sheets
"	39.37	Inches	Reams	500	Sheets
"	1.094	Yards	Sq. cms	1.076x10 ⁻³	Square Feet
Miles	5280	Feet	"	0.1550	Square inches
"	1.609	Kilometer	Square feet	2.296x10 ⁻⁵	Acres
Miles/hr.	88	Feet/min.	Square foot	144	Square inches
"	1.467	Feet/sec.	"	0.09290	Square meters
Miles/min.	88	Feet/sec.	"	3.587x10 ⁻⁸	Square miles
"	60	Miles/hr.	Square inches	6.452	Square centimeters
Mg/liter	1	Parts/million	"	6.944x10 ⁻³	Square feet
Million gals./day	1.54723	Cubic ft./min.	Square kms	247.1	Acres
Miner's inches	1.5	Cubic ft./min.	"	10.76x10 ⁶	Square feet
Newtons (N)	0.22481	Pounds	"	0.3861	Square miles
Newton-metres (Nm)	0.73756	Foot-pounds	Square meters	10.76	Square feet
Ounces (fluid)	1.805	Cubic inches	"	1.196	Square yards
"	0.02957	Liters	Square miles	640	Acres
Parts/million	0.0584	Grains/U.S. gal.	"	27.88x10 ⁶	Square feet
"	0.07016	Grains/Imp.gal.	"	3.098x10 ⁶	Square yards
"	8.345	Lbs./million gal.	Square yards	2.066x10 ⁻⁴	Acres
Pounds/sq. inch	0.06895	Bars	"	9	Square feet
Pounds	16	Ounces	"	0.8361	Square meters
"	256	Drams	"	3.228x10 ⁻⁷	Square miles
"	7000	Grains	Temp.(°C.)+273	1	Abs. temp. (°C.)
"	0.0005	Ton (short)	Temp.(°C.)+17.78	1.8	Temp. (°F.)
"	453.5924	Grams	Temp.(°F.) + 460	1	Abs. temp. (°F.)
"	1.21528	Pounds (troy)	Temp.(°F.)- 32	5/9	Temp. (°C.)
"	14.5833	Ounces (troy)	Tons (long)	1016	Kilograms
Pounds (troy)	5760	Grains	"	2240	Pounds
"	240	Pennyweights (troy)	"	1.12000	Tons (short)
"	12	Ounces (troy)	Tons (metric)	10 ³	Kilograms
"	373.24177	Grams	"	2205	Pounds
"	0.822857	Pounds (avoir)	Tons (short)	2000	Pounds
"	13.1657	Ounces (avoir)	"	907.18486	Kilograms
"	3.6735x10 ⁻⁴	Tons (long)	"	0.89287	Tons (long)
"	4.1143x10 ⁻⁴	Tons (short)	Tons-water /24 hrs.	83.333	Pounds water/hour
"	3.7324x10 ⁻⁴	Tons (metric)	"	0.16643	Gallons/min.
Pounds of water	0.01602	Cubic feet	"	1.3349	Cu. ft./hr.
"	27.68	Cubic inches	Watts	0.05692	B.t. units/min.
"	0.1198	Gallons	"	44.26	Foot-pounds/min.
Lbs water/min.	2.670x10 ⁻⁴	Cubic ft./sec.	"	1.341x10 ⁻³	Horse-power
Lbs/cubic foot	0.01602	Grams/cubic cm.	"	0.01434	Kg.-calories/min.
"	16.02	Kgs./cubic meter	Yards	91.44	Centimeters
"	5.787x10 ⁻⁴	Lbs./cubic inch	"	3	Feet
Pounds/inch	178.6	Grams/cm.	"	36	Inches
Pounds/sq. foot	0.01602	Feet of water	"	0.9144	Meters
"	4.883	Kgs./sq. meter			
"	6.945x10 ⁻³	Pounds/sq. inch			
Pounds/sq. inch	0.06804	Atmospheres			
"	2.307	Feet of water			
"	2.036	Inches of mercury			
"	703.1	Kgs./sq. meter			

PROPERTIES OF NUMBERS

Decimal Equivalents

Squares

Square Roots

Circumference and Areas of Circles

NUMBER, N		N ²	\sqrt{N}	CIRCLE (N = DIA.)		N	N ²	\sqrt{N}	CIRCLE (N = DIA.)	
FRACTION	DECIMAL			CIRCUM.	AREA				CIRCUM.	AREA
1/64	.015625	0.000244	.1250	0.04909	.00019	1.	1.0000	1.0000	3.1416	0.7854
1/32	.03125	.000977	.1768	.09818	.00077	1.125	1.2656	1.0606	3.5343	.9940
3/64	.046875	.002197	.2165	.14726	.00173	1.25	1.5625	1.1180	3.9270	1.2272
1/16	.0625	.003906	.2500	.19635	.00307	1.375	1.8906	1.1726	4.3197	1.4849
5/64	.078125	.006104	.2795	.24544	.00479	1.5	2.25	1.2247	4.7124	1.7671
3/32	.09375	.008789	.3062	.29452	.00690	1.625	2.6406	1.2748	5.1051	2.0739
7/64	.109375	.011196	.3307	.34361	.00939	1.75	3.0625	1.3229	5.4978	2.4053
1/8	.125	.01563	.3536	.39270	.01227	1.875	3.5156	1.3693	5.8905	2.7612
9/64	.140625	.019178	.3750	.44179	.01554	2.	4.0000	1.4142	6.2832	3.1416
5/32	.15625	.02441	.3953	.49087	.01917	2.125	4.5156	1.4577	6.6759	3.5466
11/64	.171875	.012954	.4146	.53996	.02320	2.25	5.0625	1.5000	7.0686	3.9761
3/16	.1875	.03516	.4330	.58905	.02761	2.375	5.6406	1.5411	7.4613	4.4301
13/64	.203125	.04126	.4507	.63814	.03241	2.5	6.2500	1.5811	7.8540	4.9087
7/32	.21875	.04785	.4677	.68722	.03758	2.625	6.8906	1.6202	8.2467	5.4119
15/64	.234375	.05493	.4841	.73631	.04314	2.75	7.5625	1.6583	8.6394	5.9396
1/4	.250	.0625	.5000	.78540	.04909	2.875	8.2656	1.6956	9.0321	6.4918
17/64	.265625	.07056	.5154	.83448	.05542	3.	9.0000	1.7321	9.4248	7.0686
9/32	.28125	.07910	.5303	.88357	.06213	3.125	9.7656	1.7678	9.8175	7.6699
19/64	.296875	.08813	.5449	.93266	.06922	3.25	10.5625	1.8028	10.2102	8.2958
5/16	.3125	.09766	.5590	.98175	.07670	3.375	11.3906	1.8371	10.6029	8.9462
21/64	.328125	.10767	.5728	1.0308	.08456	3.5	12.2500	1.8708	10.9956	9.6211
11/32	.34375	.11816	.5863	1.0799	.09281	3.625	13.1406	1.9039	11.3883	10.3206
23/64	.359375	.12915	.5995	1.1290	.10143	3.75	14.0625	1.9365	11.7810	11.0447
3/8	.375	.14063	.624	1.1781	.11045	3.875	15.0156	1.9685	12.1737	11.7932
25/64	.390625	.15259	.6250	1.2272	.11984	4.	16.0000	2.0000	12.5664	12.5664
13/32	.40625	.16504	.6374	1.2763	.12962	4.125	17.0145	2.0310	12.9591	13.3640
27/64	.421875	.17798	.6495	1.3254	.13979	4.25	18.0625	2.0616	13.3518	14.1863
7/16	.4375	.19141	.6614	1.3744	.15033	4.375	19.1406	2.0916	13.7445	15.0330
29/64	.453125	.20532	.6732	1.4235	.16126	4.5	20.2500	2.1213	14.1372	15.9043
15/32	.46875	.21973	.6847	1.4725	.17257	4.625	21.3906	2.1506	14.5299	16.8001
31/64	.484375	.23562	.6960	1.5217	.18427	4.75	22.5625	2.1795	14.9226	17.7205
1/2	.50	.2500	.7071	1.5708	.19635	4.875	23.7656	2.2079	15.3153	18.6655
33/64	.515625	.26587	.7181	1.6199	.20881	5.	25.0000	2.2361	15.7080	19.6350
17/32	.53125	.28223	.7289	1.6690	.22166	5.125	26.2656	2.2638	16.1006	20.6289
35/64	.546875	.29907	.7395	1.7181	.23489	5.25	27.5625	2.2913	16.4933	21.6475
9/16	.5625	.31641	.7500	1.7671	.24850	5.375	28.8906	2.3184	16.8860	22.6906
37/64	.578125	.33423	.7604	1.8162	.26250	5.5	30.2500	2.3452	17.2787	23.7583
19/32	.59375	.35254	.7706	1.8653	.27688	5.625	31.6406	2.3727	17.6714	24.8505
39/64	.609375	.37134	.7806	1.9144	.29165	5.75	33.0625	2.3979	18.0641	25.9672
5/8	.625	.39063	.7906	1.9635	.30680	5.875	34.5156	2.4238	18.4568	27.1085
41/64	.640625	.41040	.8004	2.0126	.32233	6.	36.0000	2.495	18.8495	28.2743
21/32	.65625	.43066	.8101	2.0617	.33824	6.125	37.5156	2.4749	19.2422	29.4647
43/64	.671875	.45142	.8197	2.1108	.35454	6.25	39.0625	2.5000	19.6349	30.3796
11/16	.6875	.47266	.8297	2.1598	.37122	6.375	40.6406	2.5249	20.0276	31.9190
45/64	.703125	.49438	.8385	2.2089	.38829	6.5	42.2500	2.5495	20.4203	33.1831
23/32	.71875	.51660	.8478	2.2580	.40574	6.625	43.8906	2.5739	20.8130	34.4716
47/64	.734375	.53931	.8570	2.3071	.42357	6.75	45.5625	2.5981	21.2057	35.7847
3/4	.750	.56250	.8660	2.3562	.44179	6.875	47.2656	2.6220	21.5984	37.1223
49/64	.765625	.58618	.8750	2.4053	.46038	7.	49.0000	2.6458	21.9911	38.4845
25/32	.78125	.61035	.8839	2.4544	.47937	7.125	50.7657	2.6693	22.3838	39.8712
51/64	.796875	.63501	.8927	2.5035	.49884	7.25	52.5625	2.6926	22.7765	41.2825
13/16	.8125	.66016	.9014	2.5525	.51849	7.375	54.3906	2.7157	23.1692	42.7183
53/64	.828125	.68579	.9100	2.6016	.53862	7.5	56.2500	2.7386	23.5619	44.1786
27/32	.84375	.71191	.9186	2.6507	.55914	7.625	58.1406	2.7613	23.9546	45.6635
55/64	.859375	.73853	.9270	2.6998	.58004	7.75	60.0625	2.7839	24.3473	47.1730
7/8	.875	.76563	.9354	2.7489	.60132	7.875	62.0156	2.8063	24.7400	48.7069
57/64	.890625	.79321	.9437	2.7980	.62299	8.	64.0000	2.8284	25.1327	50.2655
29/32	.90625	.82129	.9520	2.8471	.64504	8.125	66.0156	2.8504	25.5254	51.8485
59/64	.921875	.84985	.9601	2.8962	.66747	8.25	68.0625	2.8723	25.9181	53.4562
15/16	.9375	.87891	.9683	2.9452	.69029	8.375	70.1406	2.8940	26.3108	55.0883
61/64	.953125	.90845	.9763	2.9943	.71349	8.5	72.2500	2.9155	26.7035	56.7450
31/32	.96875	.93848	.9843	3.0434	.73708	8.625	74.3906	2.9368	27.0962	58.4262
63/64	.984375	.96899	.9922	3.0925	.76104	8.75	76.5625	2.9580	27.4889	60.1320
						8.875	78.7656	2.9791	27.8816	61.8623

CONTINUED

NUMBER, N		N ²	\sqrt{N}	CIRCLE (N = DIA.)	NUMBER, N		N ²	\sqrt{N}	CIRCLE (N = DIA.)
FRACTION	DECIMAL			CIRCUM.	FRACTION	DECIMAL			CIRCUM.
9.	81.0000	3.0000	28.2742	63.6172	66	4356	8.1240	207.3449	3421.194
9.125	83.2656	3.0207	28.6670	65.3966	67	4489	8.1854	210.4865	3525.652
9.25	85.5625	3.0414	29.0597	67.2006	68	4624	8.2462	213.6281	3631.680
9.375	87.8906	3.0619	29.4524	69.0291	69	4761	8.3066	216.7696	3739.280
9.5	90.2500	3.0822	29.8451	70.8822	70	4900	3.3666	219.9113	3848.450
9.625	92.6406	3.1024	30.2378	72.7597	71	5041	8.4261	223.0529	3959.191
9.75	95.0625	3.1225	30.6305	74.6619	72	5184	8.4853	226.1945	4071.503
9.875	97.5156	3.1425	31.0232	76.5886	73	5329	8.5440	229.3361	4185.386
10	100	3.1623	31.4159	78.5398	74	5476	8.6023	232.4777	4300.839
11	121	3.3166	34.5575	95.0332	75	5625	8.6603	235.6193	4417.864
12	144	3.4641	39.6991	113.0973	76	5776	8.7178	238.7608	4536.459
13	169	3.6056	40.8407	132.7323	77	5929	8.7750	241.9024	4656.625
14	196	3.7417	43.9823	153.9380	78	6084	8.8318	245.0440	4778.361
15	225	3.8730	47.1239	176.7146	79	6241	8.8882	248.1856	4901.669
16	256	4.0000	50.2654	201.0619	80	6400	8.9443	251.327	5026.547
17	289	4.1231	53.4070	226.9901	81	6561	9.0000	254.469	5152.998
18	324	4.2426	56.5486	264.4680	82	6724	9.0554	257.610	5281.016
19	361	4.3589	59.6902	283.2587	83	6889	9.1104	260.742	5410.607
20	400	4.4721	62.8318	314.1593	84	7056	9.1652	263.894	5541.770
21	441	4.5826	65.9734	346.3606	85	7225	9.2195	267.035	5674.501
22	484	4.6904	69.1150	380.1327	86	7396	9.2736	270.177	5808.805
23	529	4.7958	72.2566	415.4758	87	7569	9.3274	273.318	5944.679
24	576	4.8990	75.3982	452.3893	88	7744	9.3800	276.460	6082.124
25	625	5.0000	78.5398	490.8739	89	7921	9.4340	279.602	6221.138
26	676	5.0990	81.6813	530.9292	90	8100	9.4868	282.743	6361.725
27	729	5.1962	84.8229	572.5553	91	8281	9.5394	285.885	6503.882
28	784	5.2915	87.9645	615.7522	92	8464	9.5917	289.026	6647.610
29	841	5.3852	91.1061	660.5198	93	8649	9.6437	292.168	6792.090
30	900	5.4772	94.2477	706.8583	94	8836	9.6954	295.309	6939.778
31	961	5.5678	97.3893	754.7676	95	9025	9.7468	298.451	7088.219
32	1024	5.6569	100.5309	804.2477	96	9216	9.7980	301.593	7238.230
33	1089	5.7446	103.6725	855.2986	97	9409	9.8489	304.734	7389.812
34	1156	5.8310	106.8141	907.9203	98	9604	9.8995	307.876	7697.688
35	1225	5.9161	109.9557	962.1127	99	9801	9.9499	311.017	7697.688
36	1296	6.0000	113.0972	1017.8760	100	10000	10.0000	314.159	7853.982
37	1369	6.0828	116.2388	1075.2101	101	10201	10.0499	317.301	8011.85
38	1444	6.1644	119.3804	1134.1149	102	10404	10.0995	320.442	8171.28
39	1521	6.2450	122.5220	1194.5906	103	10609	10.1489	323.584	8332.29
40	1600	6.3245	125.6636	1256.6371	104	10816	10.1980	326.725	8498.87
41	1681	6.4031	128.8052	1320.2543	105	11025	10.2470	329.867	8659.01
42	1764	6.4807	131.9468	1385.4424	106	11236	10.2956	333.009	8824.73
43	1849	6.5574	135.0884	1452.2012	107	11449	10.3441	336.150	8992.09
44	1936	6.6332	138.2300	1520.5308	108	11664	10.3923	339.292	9160.88
45	2025	6.7082	141.3716	1590.4313	109	11881	10.4403	342.433	9331.32
46	2116	6.7823	144.5131	1661.9025	110	12100	10.4881	345.575	9503.32
47	2209	6.8557	147.6547	1734.9445	111	12321	10.5357	348.716	9676.89
48	2304	6.9282	150.7963	1809.5574	112	12544	10.5830	351.858	9852.03
49	2401	7.0000	153.9379	1885.7410	113	12769	10.6301	355.000	10028.75
50	2500	7.0711	157.0795	1963.5000	114	12996	10.6771	358.141	10207.03
51	2601	7.1414	160.2211	2042.820	115	13225	10.7238	361.283	10386.89
52	2704	7.2111	163.3627	2123.716	116	13456	10.7703	364.424	10568.32
53	2809	7.2801	166.5043	2206.183	117	13689	10.8167	367.566	10751.31
54	2916	7.3485	169.6459	2290.2121	118	13924	10.8628	370.708	10935.88
55	3025	7.4162	172.7875	2375.829	119	14161	10.9087	373.849	11122.02
56	3136	7.4833	175.9290	2463.008	120	14400	10.9545	376.991	11309.73
57	3249	7.5498	179.0706	2551.758	121	14641	11.0000	380.132	11499.01
58	3364	7.6158	182.2122	2642.079	122	14884	11.0454	383.274	11689.86
59	3481	7.6811	185.3538	2733.970	123	15129	11.0905	386.416	11882.29
60	3600	7.7460	188.4954	2827.433	124	15376	11.1355	389.557	12076.28
61	3721	7.8102	191.6370	2922.466	125	15625	11.1803	392.699	12271.84
62	3844	7.8740	194.7786	3019.070	126	15876	11.2250	395.840	12468.98
63	3969	7.9373	197.9202	3117.245	127	16129	11.2694	398.982	12667.68
64	4096	8.0000	201.0618	3216.990	128	16384	11.3137	402.124	12867.96
65	4225	8.0623	204.2034	3318.307	129	16641	11.3578	405.265	13069.81

LINEAR EXPANSION OF DUCTILE IRON PIPE

The coefficient of linear expansion of ductile iron may be taken as 0.0000062 per degree Fahrenheit. The expansion or contraction in inches that will take place in a line of given length with various temperature changes is shown in the following table:

TEMP. DIFFERENCE °F	LENGTH OF LINE IN FEET			
	100	500	1000	5280
	EXPANSION OR CONTRACTION IN INCHES			
5	0.037	0.19	0.37	1.96
10	0.974	0.37	0.74	3.93
20	0.149	0.74	1.49	7.86
30	0.223	1.12	2.23	11.78
40	0.298	1.49	2.98	15.71
50	0.372	1.86	3.72	19.64
60	0.446	2.23	4.46	23.57
70	0.521	2.60	5.21	27.50
80	0.595	2.98	5.95	31.43
90	0.670	3.35	6.70	35.35
100	0.744	3.72	7.44	39.28
120	0.893	4.46	8.93	47.14
150	1.116	5.58	11.16	58.92

INCHES CONVERTED TO DECIMALS OF A FOOT

INCHES		DECIMAL OF A FOOT		INCHES		DECIMAL OF A FOOT	
0	1/8	.010416	6	1/8	.510416		
	1/4	.020833		1/4	.520833		
	3/8	.031250		3/8	.531250		
	1/2	.041666		1/2	.541666		
	5/8	.052083		5/8	.552083		
	3/4	.062500		3/4	.562500		
	7/8	.072916		7/8	.572916		
1 .083333	1/8	.09375	7	1/8	.593750		
	1/4	.104166		1/4	.604166		
	3/8	.114583		3/8	.614583		
	1/2	.125000		1/2	.625000		
	5/8	.135416		5/8	.635416		
	3/4	.145833		3/4	.645833		
	7/8	.156250		7/8	.656250		
2 .166666	1/8	.177083	8	1/8	.677083		
	1/4	.187500		1/4	.687500		
	3/8	.197916		3/8	.697916		
	1/2	.208333		1/2	.708333		
	5/8	.21875		5/8	.718750		
	3/4	.229166		3/4	.729166		
	7/8	.239583		7/8	.739583		
3 .250	1/8	.260416	9	1/8	.760416		
	1/4	.270833		1/4	.770833		
	3/8	.281250		3/8	.781250		
	1/2	.291666		1/2	.791666		
	5/8	.302083		5/8	.802083		
	3/4	.312500		3/4	.812500		
	7/8	.322916		7/8	.822916		
4 .333333	1/8	.343750	10	1/8	.843750		
	1/4	.354166		1/4	.854166		
	3/8	.36453		3/8	.864583		
	1/2	.375000		1/2	.875000		
	5/8	.385416		5/8	.885416		
	3/4	.395833		3/4	.895833		
	7/8	.406250		7/8	.906250		
5 .416666	1/8	.427083	11	1/8	.927083		
	1/4	.437500		1/4	.937500		
	3/8	.447916		3/8	.947916		
	1/2	.458333		1/2	.958333		
	5/8	.468750		5/8	.968750		
	3/4	.479166		3/4	.979166		
	7/8	.489583		7/8	.989583		

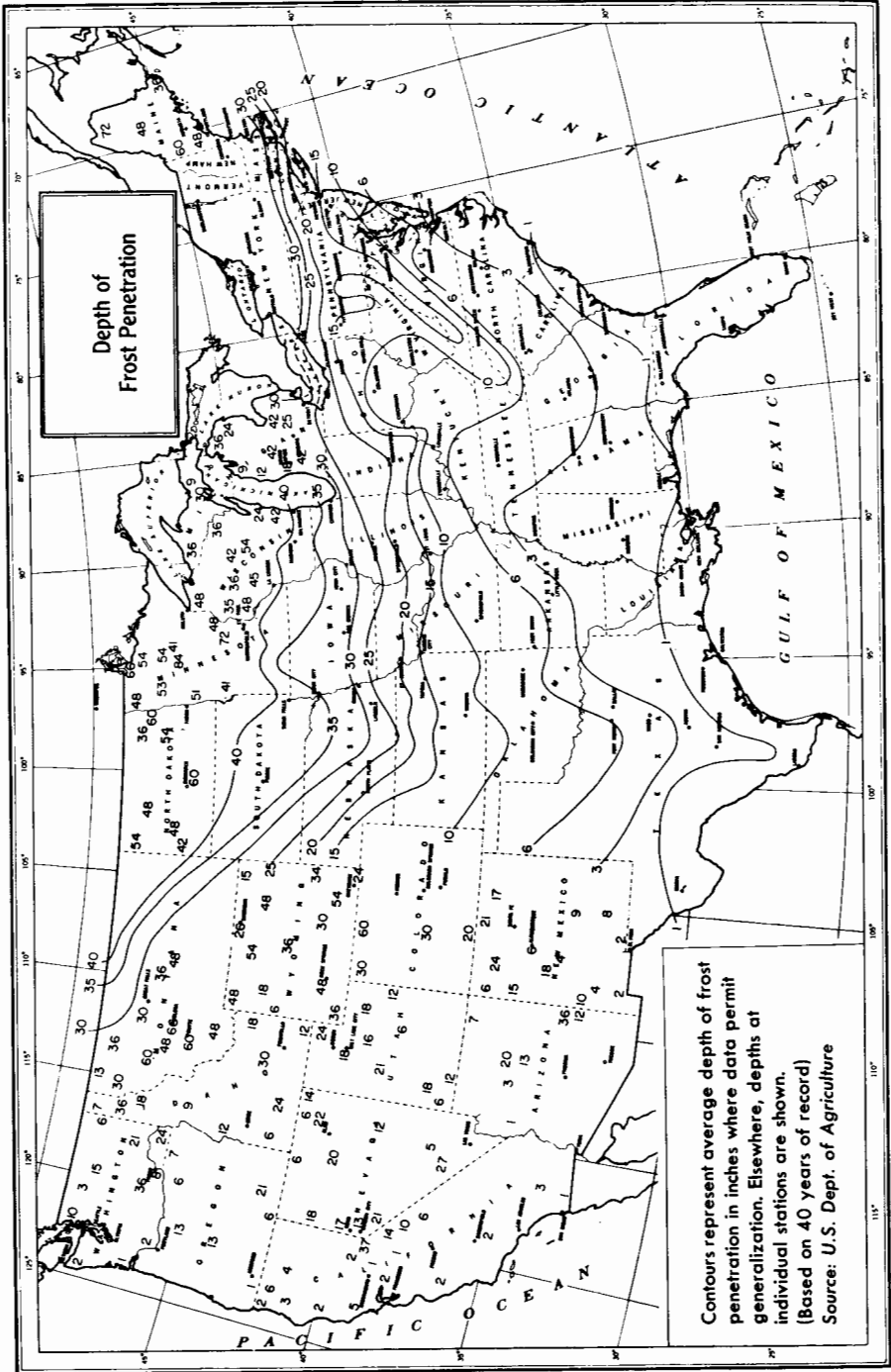

**MASTER
INDEX**

Ductile Iron Pipe Section Index	5
Fire Hydrant Section Index	111
Fittings Section Index	41
McWane Inc. Division Offices	i
Ransom Industries, Inc. Division Offices	i
Technical Data Section Index	229
Terms	ii
Valves Section Index	147
Warranty	ii

This page intentionally left blank.

PIPE ECONOMY